



USER INSTRUCTIONS

POD HIU

When replacing any part on this appliance, use only spare parts that you can be assured conform to the safety and performance specification that we require. Do not use reconditioned or copy parts that have not been clearly authorised by Ideal Heating.

For the very latest copy of literature for specification and maintenance practices visit our website idealheating.com where you can download the relevant information in PDF format.



CONTENTS

- 1. Introduction.....3
- 1.1 Safety3
- 1.2 Electrical Supply3
- 1.3 Important Notes3
- 2. HIU Operation.....4
- 3. System Water Pressure.....6
- 4. General Information.....7
- 5. Points for the HIU User.....7
- 6. Troubleshooting8
- 7. Display Functions - Normal Operation.....8
- 8. Display Functions - Fault Messages..... 10

1 INTRODUCTION

The Ideal POD HIU is a wall mounted, electronically controlled Heat Interface Unit (HIU) for use with district or community heating systems, available in Indirect or Direct models.

Domestic Hot Water (DHW) output is fully modulating with a maximum of:

- 30, 40, 50, 60 or 70 kW for Indirect units
- 30, 40, 50 or 60 kW for Direct units.

Central Heating (CH) output is also fully modulating with a maximum of:

- 5 kW for all models.

The HIU is supplied fully assembled with DHW plate heat exchanger and Pressure Independent Control Valves (PICVs.) Indirect versions also include a plate heat exchanger, circulating pump, pressure gauge, safety valve and expansion vessel within the CH circuit. There are also optional extras available for the HIU such as heat meters and Credit Control valves (CCVs.) Please see the installation manual for full list of option kits.

1.1 SAFETY

CURRENT SAFETY (INSTALLATION & USE) REGULATIONS OR RULES IN FORCE

The HIU must be installed by a competent person trained in Heat Network product installations, in accordance to Heat Network code of practice (installation and use) regulations or other rules in force.

The appliance is suitable only for installation in GB and IE and should be installed in accordance with the rules in force.

It must be carried out in accordance with the relevant requirements of the:

- Heat Networks code of practice (Installation and Use) Regulations.
- Appropriate Building Regulations, either. The Building Regulations (England and Wales), The Building Regulations (Scotland), Building Regulations (Northern Ireland).
- Water Fittings Regulations or Water byelaws in Scotland. Current I.E.E. Wiring Regulations.

Where no specific instructions are given, reference should be made to the relevant British Standard Code of Practice.

The current Building Regulations and reference should be made to the current ETCI rules for electrical installation.

Detailed recommendations are contained in the following British Standard Codes of Practice:

CIBSE CP1 (2020) Heat Network code of practice.

BS EN 12828 Heating Systems in buildings: Design for water-based heating systems.

BS EN 12831 Heating Systems in buildings: Method for calculation of the design heat load.

BS EN 14336 Heating Systems in buildings: Installation and commissioning of water-based heating systems.

BS 6891 Low pressure installation pipes.

Health & Safety Document No. 635.

The Electricity at Work Regulations, 1989.

It is essential that the instructions in this booklet are strictly followed, for safe and economical operation of the HIU.

1.2 ELECTRICITY SUPPLY

This appliance must be earthed.

Supply: 230 V ~ 50 Hz. The fusing should be 3A.

Wiring external to the appliance MUST be in accordance with the current I.E.E. (BS 7671) Wiring Regulations and any local regulations which apply. For IE reference should be made to the current ETCI rules for electrical installations.

The mains supply to the HIU and system wiring centre shall be through one common fused double pole isolator and for new heating systems, and where practical replacement installations, the isolator shall be situated adjacent to the appliance.

1.3 IMPORTANT NOTES

- This appliance must not be operated without the casing correctly fitted.
- If the HIU is installed in a compartment then the compartment must be well ventilated and not used for storage purposes.
- If it is known or suspected that a fault exists on the HIU then it MUST NOT BE USED until the fault has been corrected by a qualified engineer.
- Under NO circumstances should any of the sealed components on this appliance be used incorrectly or tampered with.
- This appliance can be used by children 8 years and above. Also, persons with reduced physical, sensory or mental capabilities, or lack of experience and knowledge, provided they have been given supervision or instruction concerning use of the appliance in a safe way and understand the hazards involved. Children shall not play with the appliance. Cleaning and user maintenance shall not be made by children without supervision.

2 HIU OPERATION

CONTROLS DIAGRAM

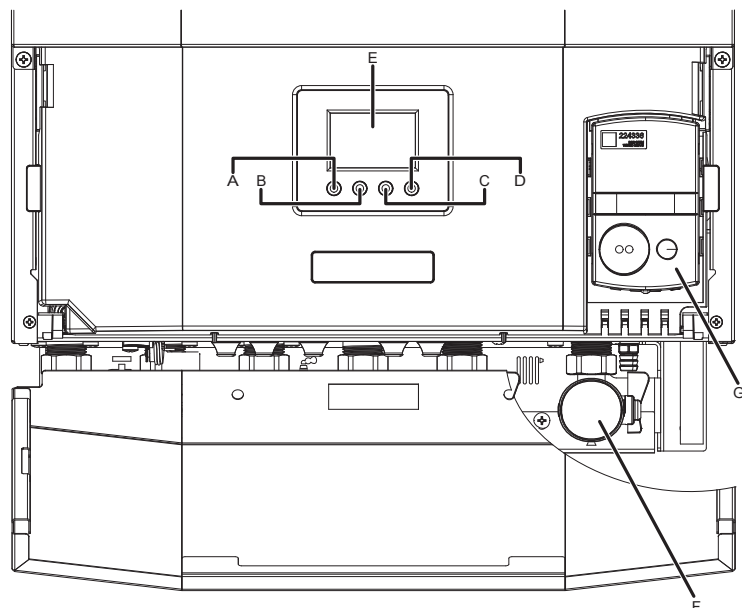

Legend

- A. Reset Button
- B. - Function Button
- C. + Function Button
- D. Menu Button
- E. HIU Status Display
- F. CH System Pressure Gauge (Indirect Only)
- G. Heat Meter (Optional)

TO START THE HIU

If a programmer is fitted refer to separate instructions for the programmer before continuing.

Start the HIU as follows:

1. To switch the domestic hot water and central heating on and off or adjust the target temperatures use the Menu button (D) to navigate the status display (E).
2. In the 'off' mode the HIU will display the following:

HIU Off Mode

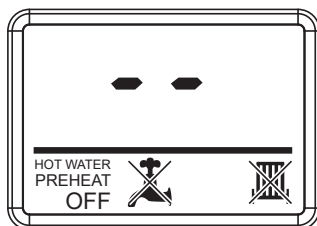

3. From normal operation screen press the Menu button to access the DHW target temperature setting menu.



4. The DHW target temperature can now be adjusted by pressing the +/- buttons within the installer defined limits.

5. Press the Menu button again to access the CH target temperature setting menu.



6. The CH target temperature can now be adjusted by pressing the +/- buttons within the installer defined limits.

Note: If using underfloor heating ensure CH target temperature is within the safe operating temperature for the underfloor heating.

7. Press the Menu button again to access the CH state setting menu.

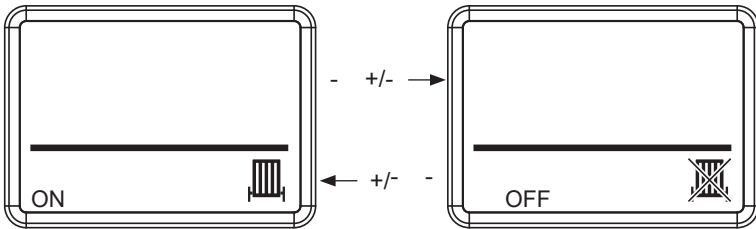

8. Press the +/- buttons to either enable or disable the CH operation.

9. Press the Menu button again to access the DHW state setting menu.

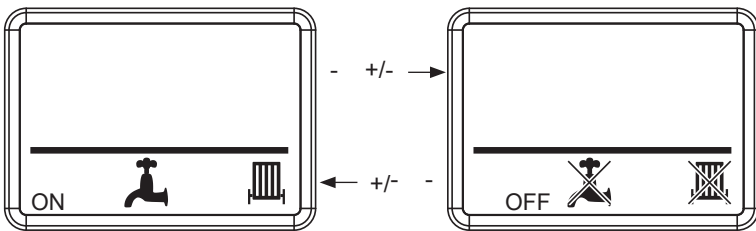

10. Press the +/- buttons to either enable or disable the DHW operation.

11. Press the Menu button again to access the DHW preheat state setting menu.

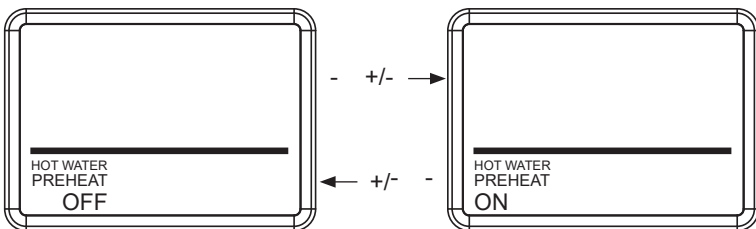

12. Press the +/- buttons to either enable or disable the DHW preheat operation

13. Press the Menu button again to return to normal operation.

If the HIU displays a fault, please refer to the troubleshooting section.

3 CH SYSTEM WATER PRESSURE (INDIRECT MODELS ONLY)

The system pressure gauge (see page 4) indicates the central heating system pressure. If the pressure is seen to fall below the original installation pressure of 1-2 bar over a period of time and continues to fall then a water leak may be indicated. In this event re-pressurise the system as shown below. If unable to do so or if the pressure continues to drop an Approved Engineer should be consulted.

THE HIU WILL NOT PROVIDE CH IF THE PRESSURE HAS REDUCED TO LESS THAN 0.3 BAR UNDER THIS CONDITION.

Filling CH / Topping up (Indirect Only)

1. Ensure isolation valves A, E and F are in the "run" position (handle vertical) and isolation valve G is in the "off" position (handle opposing body).

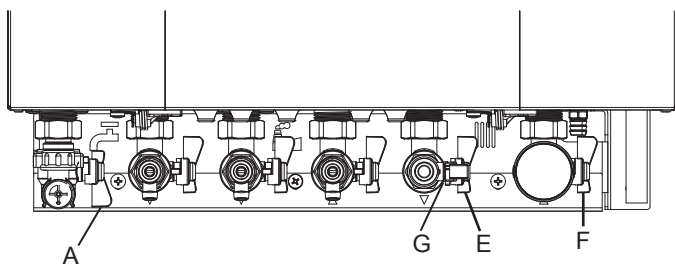

2. Remove the dust cap from valve A and plug from the filling loop adjacent to valve A.
3. Ensure top hat washers is still fitted to the valve A (if not then check inside the removed dust cap).
4. Connect the filling loop to valve A.

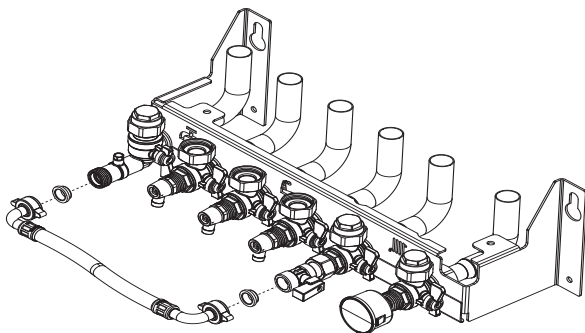

Note: Heat Interface Unit not shown for clarity
Filling Loop Hose

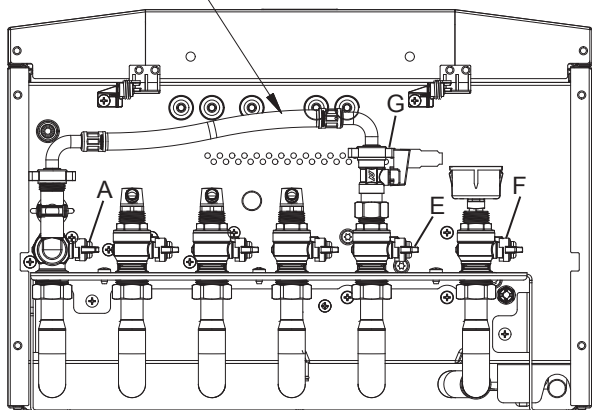

5. Turn isolation valve A to the "fill" position (handle horizontal).
6. Turn valve G to the "fill" position (handle in line with valve body). The CH circuit will begin to fill.
7. Monitor the pressure gauge until the correct pressure is achieved (max 2.75 Bar, recommended 1 – 1.5 bar for normal operation) then turn isolation valve G to the "off" position (handle opposing valve body) to isolate the charge supply.



Note: If refilling the unit or system rather than topping up, air may require manual venting from the CH circuit by a certified agent. Refer to the installation and servicing instructions for more information.

8. Turn isolation valve A to the "run" position (handle vertical).
9. Remove the filling loop hose from valve A. Insert storage plug into left side of filling loop hose.
Note: A small volume of water may remain within the hose.
10. Ensure top hat washer is still attached to isolation valve A.
11. Screw the dust cap to the front of isolation valve A.

4 GENERAL INFORMATION

HIU PUMP (INDIRECT ONLY)

The HIU pump will operate briefly as a self-check once every 24 hours, regardless of system demand.

MINIMUM CLEARANCES

Clearance of 100 mm above, 80 mm below the bottom of wall bracket, 20 mm at the sides and 600mm at the front of the HIU casing to allow for servicing.

CLEANING

For normal cleaning simply dust with a dry cloth. To remove stubborn marks and stains, wipe with a damp cloth and finish off with a dry cloth. DO NOT use abrasive cleaning materials.

MAINTENANCE

The appliance should be serviced at least once a year by an approved engineer.

5 POINTS FOR THE HIU USER

Note: *In line with our current warranty policy we would ask that you check through the following guide to identify any problems external to the HIU prior to requesting a service engineers visit. Should the problem be found to be other than with the appliance we reserve the right to levy a charge for the visit, or for any pre-arranged visit where access is not gained by the engineer.*

6 TROUBLESHOOTING

CCV = Credit Control Valve

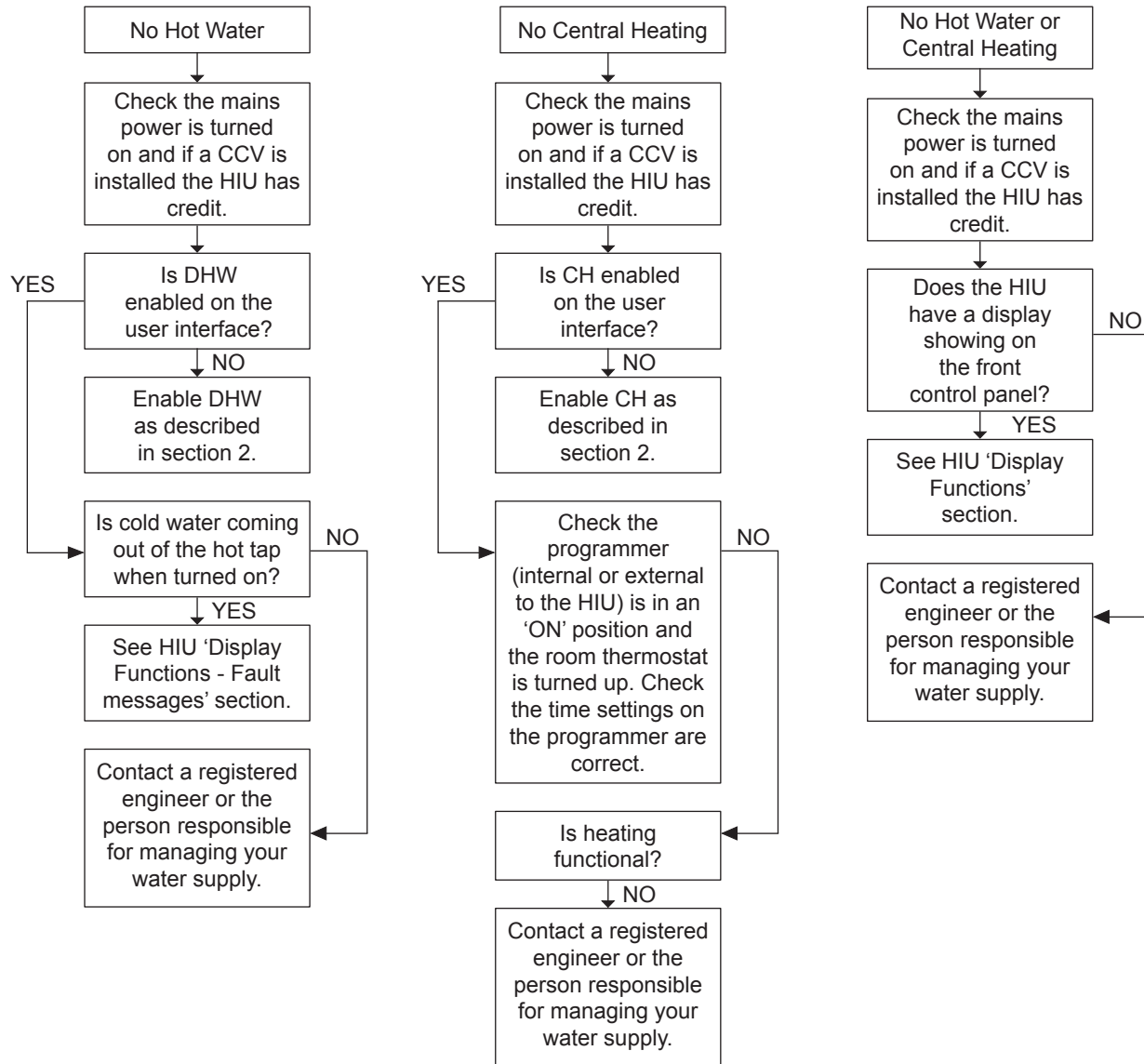

7 DISPLAY FUNCTIONS - NORMAL OPERATION MODE

Note: The temperatures shown below are for illustration purposes only. The measured temperatures will be shown on the HIU.

HIU 'Off' Mode:

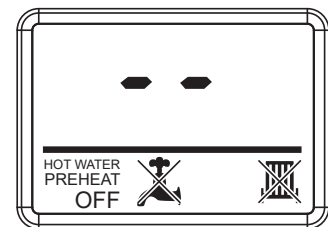

Summer Mode, DHW enabled and no heat demand:

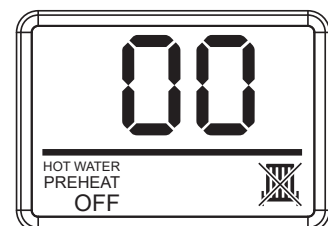

DISPLAY FUNCTIONS - NORMAL OPERATION MODE CONT'D

Summer Mode, DHW enabled with heat demand:

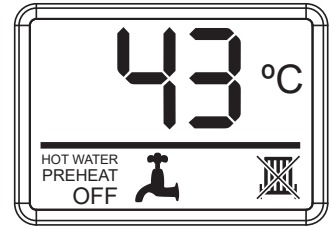

Winter Mode, DHW and CH enabled, no heat demand:

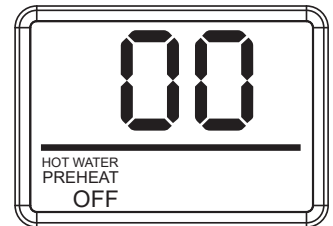

Winter Mode, with DHW heat demand:

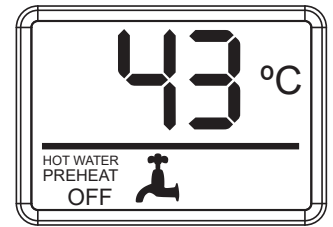

Winter Mode, with CH heat demand:

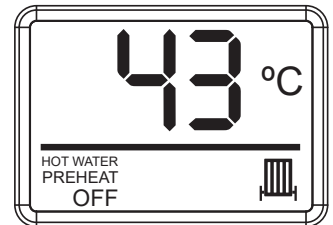

HIU hot water preheating - will alternate with the current DHW temperature:

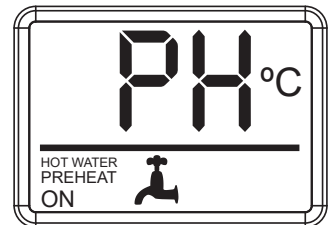

HIU frost protection - will alternate with the current frost protection temperature:

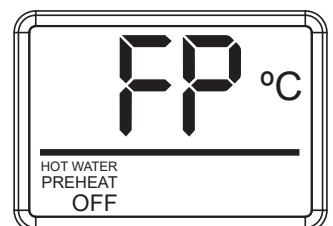

8 DISPLAY FUNCTIONS - FAULT MESSAGES

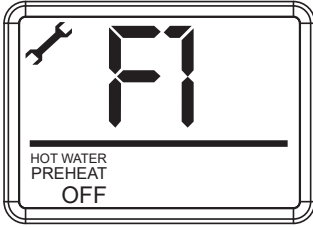
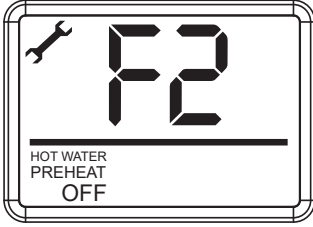
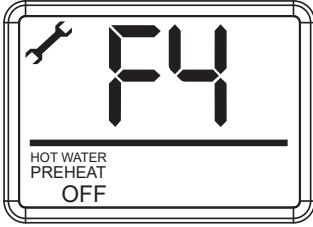
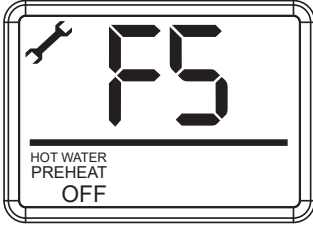
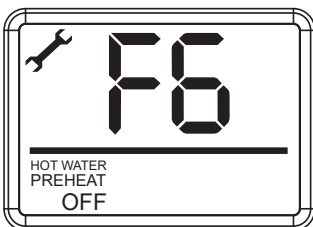
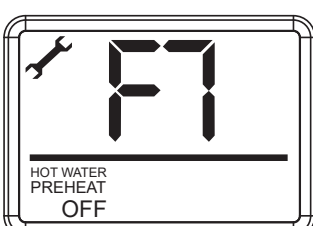
Display	Fault	Action
	Low Water Pressure	Check system water pressure is between 1 and 1.5 bar on the system pressure gauge. To re pressurise the system see section 3. If HIU continues to show fault, please contact Ideal (if under warranty) or contact a suitable qualified service engineer.
	No change in DHW Temperature during demand period	Check primary circuit is fully open and all isolation valves at base of HIU are open. If a CCV (credit control valve) is installed in appliance, ensure dwelling has sufficient credit. Reset the appliance – If HIU continues to show fault please contact Ideal (if under warranty) or contact a suitable qualified service engineer.
	Flow Thermistor Fault	Reset the appliance – If HIU continues to show fault please contact Ideal (if under warranty) or contact a suitable qualified service engineer.
	Return Thermistor Fault	Reset the appliance – If HIU continues to show fault please contact Ideal (if under warranty) or contact a suitable qualified service engineer.
	Outside Sensor Open Circuit	Power down appliance and check wiring between outside sensor and HIU if outside sensor location is known. Reset the appliance – If HIU continues to show fault please contact Ideal (if under warranty) or contact a suitable qualified service engineer.
	Incorrect Mains Voltage	Contact a qualified electrician, the building manager, or the electricity provider.

DISPLAY FUNCTIONS - FAULT MESSAGES CONT'D

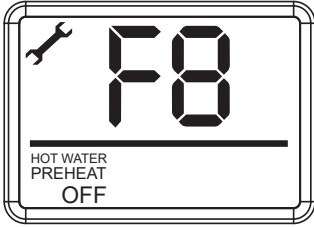
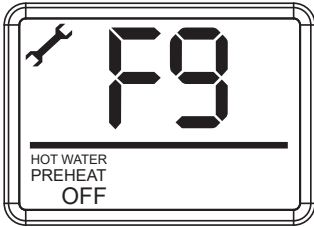
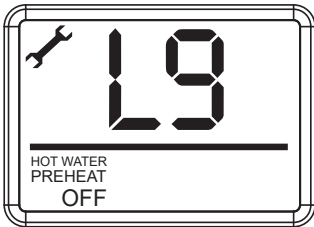
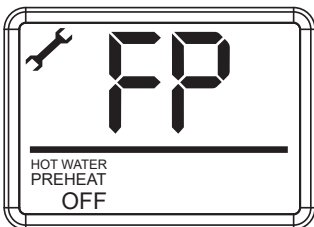
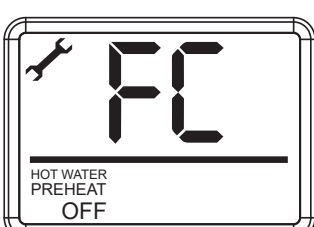
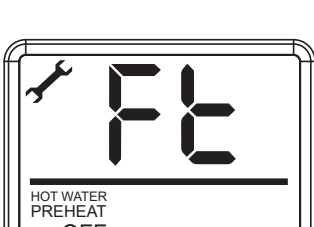
Display	Fault	Action
	Primary Thermistor Fault	Reset the appliance – If HIU continues to show fault please contact Ideal (if under warranty) or contact a suitable qualified service engineer.
	PCB Fault	Unconfigured/Faulty PCB. Please contact Ideal (if under warranty) or contact a suitable qualified service engineer.
	PCB Fault	Unconfigured/Faulty PCB. Please contact Ideal (if under warranty) or contact a suitable qualified service engineer.
	Pump Failure	Check system water pressure is between 1 and 1.5 bar on the system pressure gauge. Reset the appliance – If HIU continues to show fault please contact Ideal (if under warranty) or contact a suitable qualified service engineer.
	DHW Thermistor Fault	Reset the appliance – If HIU continues to show fault please contact Ideal (if under warranty) or contact a suitable qualified service engineer.
	OpenTherm Plus Fault	Check connection between smart thermostat and HIU. Refer to Smart thermostat fault finding. Reset the appliance – If HIU continues to show fault please contact Ideal (if under warranty) or contact a suitable qualified service engineer.



FM 59915
Manufactured under
an ISO 9001
registered quality
management system

At Ideal Heating we take our environmental impact seriously, therefore when installing any Ideal Heating product please make sure to dispose of any previous appliance in an environmentally conscious manner. Households can contact their local authority to find out how. See <https://www.gov.uk/managing-your-waste-an-overview> for guidance on how to efficiently recycle your business waste.

Technical Training

Our Expert Academy offer a range of training options designed and delivered by our experts in heating. For details please contact:
expert-academy.co.uk

Ideal Boilers Ltd., pursues a policy of continuing improvement in the design and performance of its products. The right is therefore reserved to vary specification without notice.

Ideal is a trademark of Ideal Boilers.

Registered Office

Ideal Boilers Ltd., National Avenue, Hull, East Yorkshire, HU5 4JB

Tel 01482 492251 Fax 01482 448858

Registration No. London 322 137

Ideal Commercial Technical Helpline: 01482 498376

Ideal Parts: 01482 498665

idealheating.com

ideal
HEATING