



FLUSHING BYPASS PERMANENT KIT INSTRUCTIONS

**POD HIU
i305 i405 i505 i605 i705
D30 D40 D50 D60**

When replacing any part on this appliance, use only spare parts that you can be assured conform to the safety and performance specification that we require. Do not use reconditioned or copy parts that have not been clearly authorised by Ideal Heating.

For the very latest copy of literature for specification and maintenance practices visit our website idealheating.com where you can download the relevant information in PDF format.



This kit is suitable only for the Heat Interface Units listed below:

First Fix Kit POD HIU Indirect:

- POD i305
- POD i405
- POD i505
- POD i605
- POD i705

First Fix Kit POD HIU Direct:

- POD D30
 - POD D40
 - POD D50
 - POD D60
-

1 INTRODUCTION

This kit provides facility to flush the primary pipework connected to the appliance as part of installation best practices. The kit is permanently installed within the primary system pipework to enable flushing with the appliance installed.

For guidance on flushing procedures for heat networks refer to CIBSE CP1.

2 KIT CONTENTS

- A. Bypass Unit1 off
- B. Gasket Fibre G14 off
- C. Instructions1 off

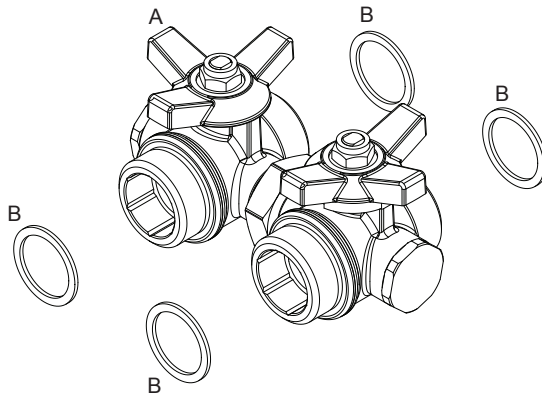

3 INSTALLATION

The below steps assume the appliance's bracketry, valves and pipework have been installed and tested as per the steps listed within the First Fix Kit's installation instructions.

1. Identify a suitable location for the bypass unit to be installed within the primary system's network. For best results this should be as close to the appliance's connections as possible.

When used with Ideal's POD HIU it is recommended to locate the bypass unit as follows:

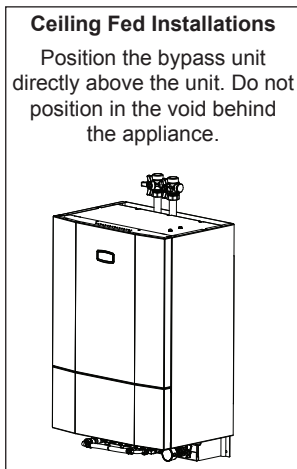
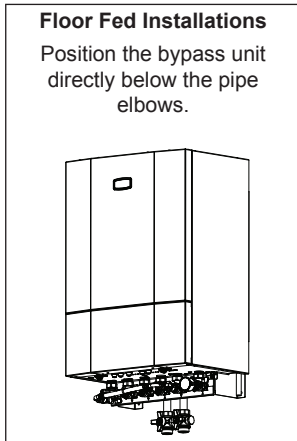

In both instances, ensure the unit can be easily accessed and the valve position verified by visual inspection.

2. Ensure all associated pipework is isolated and drained.
3. Modify or install pipework to create the arrangement shown below. Pipework must be positioned at 65mm centres and provided with 1" female union joints (R3/4 to G1 union kit available for this purpose).

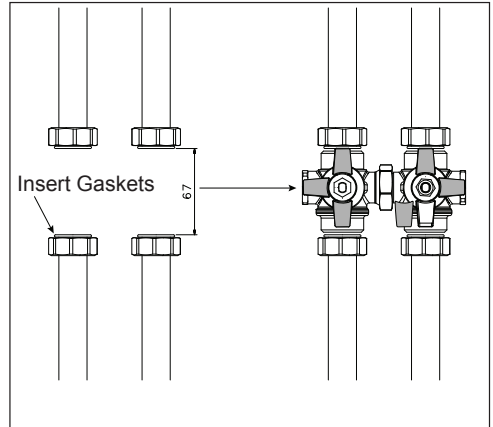

4. Whilst fitting pipe and / or adapters, the appropriately sized wrenches should be used to take the reaction force generated on the valve body when making the joint. Place the bypass unit into the pipework and secure using supplied fibre gaskets (B). Nuts must be secured to 60 Nm.

Note: The bypass unit is bi-directional.

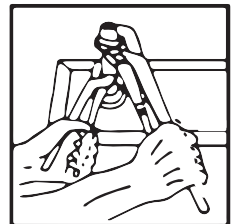
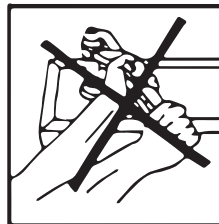

4 OPERATION MODES

The flow paths within the bypass unit are illustrated by the spurs on the handles. The below table shows the different modes and their uses.

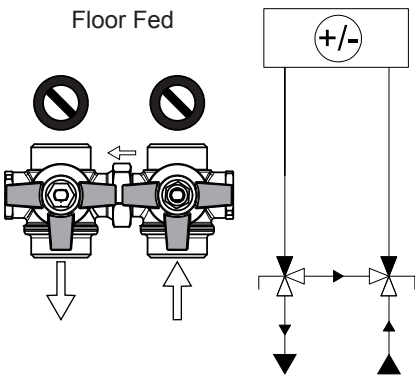
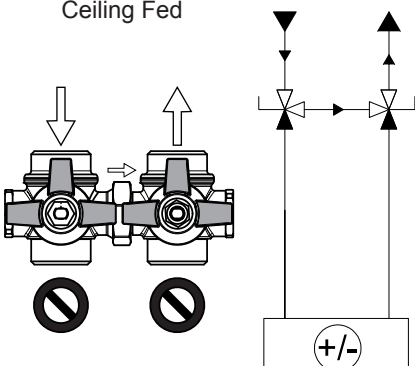
<p>Mode 1</p> <p>Flushing with isolation of appliance.</p>	<p>In this mode the bypass is activated by connecting the inlet to the outlet of the opposite circuit and isolating the appliance connections.</p> <p>Note: Unintended use of this mode while the system is in normal operation will result in reduced system performance.</p>	<p style="text-align: center;">Floor Fed</p> 
<p>Mode 2</p> <p>Normal Operation</p>	<p>This mode should be selected for normal operation of the appliance. Here the inlet is connected to the outlet of the discreet circuits and the bypass is closed.</p>	<p style="text-align: center;">Ceiling Fed</p> 

Continued...

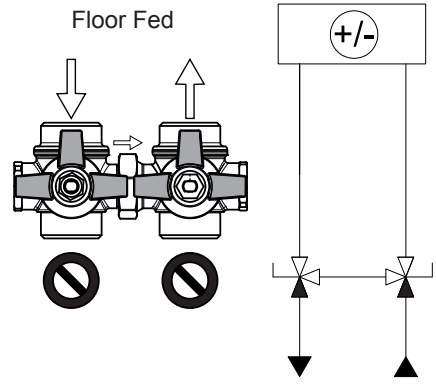
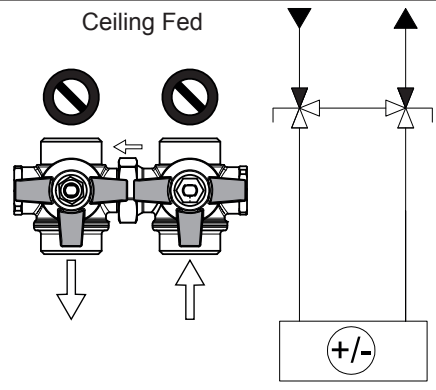
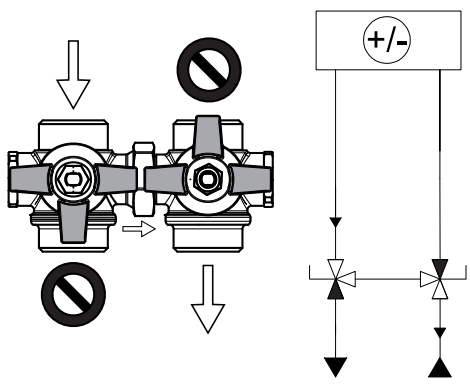
<p>Mode 3</p> <p>Appliance Isolation</p>	<p>This mode enables isolation of the appliance from the primary circuit. It is used in the opposite way to Mode 1 with a bypass created on the appliance side of the valve.</p>	<p style="text-align: center;">Floor Fed</p> 
<p>Mode 4</p> <p>Cross Path Flushing</p>	<p>This mode enables the flow to cross from the feed to the return or vice versa. This should be used in accordance with CIBSE CP1 guidance.</p>	<p style="text-align: center;">Ceiling Fed</p> 
<p>Mode 4</p> <p>Cross Path Flushing</p>	<p>This mode enables the flow to cross from the feed to the return or vice versa. This should be used in accordance with CIBSE CP1 guidance.</p>	

5 FLUSHING PROCESS

Ideally flushing of the network should be undertaken before the installation of the Heat Interface Unit. Where this is not possible, care should be taken to ensure that correct operation of the permanent flushing bypass valve is used to fully isolate the HIU from the network until flushing has been completed.

Flushing through the Heat Interface Unit is NOT permitted under any circumstance. Failure to isolate the HIU during flushing activity will invalidate the warranty.

1. Rotate the handles on the bypass unit to the positions shown in Mode 1.
2. Flush pipework from the system side of the primary network. Refer to CIBSE CP1 for best practice.
3. Once complete, rotate the handles to the positions shown in Mode 2. Failure to do so may impact the network performance.
4. Ensure the system is correctly dosed after flushing operations.



FM 59915
Manufactured under
an ISO 9001
registered quality
management system

Technical Training

Our Expert Academy offer a range of training options designed and delivered by our experts in heating.
For details please contact:
expert-academy.co.uk

Ideal Boilers Ltd., pursues a policy of continuing improvement in the design and performance of its products.
The right is therefore reserved to vary specification without notice.

Ideal is a trademark of Ideal Boilers.

Registered Office

Ideal Boilers Ltd., National Avenue, Hull, East Yorkshire, HU5 4JB

Tel 01482 492251 Fax 01482 448858

Registration No. London 322 137

Ideal Commercial Technical Helpline: 01482 498376

Ideal Parts: 01482 498665

idealheating.com

ideal
HEATING