



# *i*CCS COMMERCIAL CONTROL SYSTEM **EXTENSION MODULE**

**EVOMAX 2**

When replacing any part on this appliance, use only spare parts that you can be assured conform to the safety and performance specification that we require. Do not use reconditioned or copy parts that have not been clearly authorised by Ideal Heating.

For the very latest copy of literature for specification and maintenance practices visit our website [idealheating.com](http://idealheating.com) where you can download the relevant information in PDF format.



# CONTENTS

<p><b>1 OPERATING GUIDE ..... 6</b></p> <p>1.1 Introduction ..... 6</p> <p>1.2 Status LEDs ..... 6</p> <p>1.3 Menu ..... 6</p> <p>1.4 Menu – Heating Circuits ..... 6</p> <p>1.4.1 Menu – Heating Circuits - Status ..... 6</p> <p>1.4.2 Menu – Heating Circuits – Status - Summary ..... 6</p> <p>1.4.3 Menu – Heating Circuits – Status – Real Time Values ..... 6</p> <p>1.4.4 Menu – Heating Circuits – Status – Real Time Values – Demand Inputs ..... 6</p> <p>1.4.5 Menu – Heating Circuits – Status – Real Time Values – Sensors ..... 7</p> <p>1.4.6 Menu – Heating Circuits – Status – Real Time Values – Outputs ..... 7</p> <p>1.4.7 Menu – Heating Circuit – Operating Mode ..... 7</p> <p>1.4.8 Menu – Heating Circuit – Room Temperature ..... 7</p> <p>1.4.9 Menu – Heating Circuit – Flow Temperature ..... 8</p> <p>1.4.10 Menu – Heating Circuit – Settings ..... 8</p> <p>1.4.11 Menu – Heating Circuit – Settings - Preheat ..... 8</p> <p>1.4.12 Menu – Heating Circuit – Settings – Heating Limit ..... 8</p> <p>1.4.13 Menu – Heating Circuit – Settings – Room Temp. Switch Diff. .... 9</p> <p>1.4.14 Menu – Heating Circuit – Settings – Pump ..... 9</p> <p>1.4.15 Menu – Heating Circuit - Settings - Heating Curve ..... 9</p> <p>1.4.16 Menu – Heating Circuit - Settings - PIDs ..... 9</p> <p>1.4.17 Menu – Heating Circuit – Settings – Frost Protection ..... 9</p> <p>1.5 Menu – DHW ..... 10</p> <p>1.5.1 Menu – DHW - Status ..... 10</p> <p>1.5.2 Menu – DHW – Status - Summary ..... 10</p> <p>1.5.3 Menu – DHW – Status – Real Time Values ..... 10</p> <p>1.5.4 Menu – DHW – Status – Real Time Values – Demand Inputs ..... 10</p> <p>1.5.5 Menu – DHW – Status – Real Time Values – Sensors ..... 10</p> <p>1.5.6 Menu – DHW – Status – Real Time Values – Outputs ..... 11</p> <p>1.5.7 Menu – DHW – Operating Mode ..... 11</p> <p>1.5.8 Menu – DHW – Temperature ..... 11</p> <p>1.5.9 Menu – DHW – Settings ..... 12</p> <p>1.5.10 Menu – DHW – Settings – One Time Boost ..... 12</p> <p>1.5.11 Menu – DHW – Settings – Pump ..... 12</p> <p>1.5.12 Menu – DHW – Settings – Legionella ..... 13</p> <p>1.5.13 Menu – DHW – Settings – Frost Protection ..... 13</p> <p>1.5.14 Menu – DHW – Settings – Early Start DHW Storage ..... 13</p> <p>1.5.15 Menu – DHW – Time Clock ..... 13</p> <p>1.5.16 Menu – DHW – Holiday Programme ..... 13</p>	<p><b>2 PARTIAL HYDRAULICS ..... 14</b></p> <p><b>3 INSTALLATION ..... 25</b></p> <p>3.1 VariCAN Adapter ..... 25</p> <p>3.2 Extension Module ..... 25</p> <p>3.3 Electrical Connections ..... 26</p> <p>3.4 Heating Circuit Connections ..... 27</p> <p>3.5 Domestic Hot Water Circuit Connections ..... 27</p> <p><b>4 CONFIGURATION ..... 28</b></p> <p>4.1 System Manager Interface ..... 28</p> <p>4.2 Cascade and/or Extension Modules ..... 29</p> <p>4.3 Backup/Recovery ..... 31</p> <p>4.4 Plant Configuration ..... 31</p> <p>4.5 Boiler Configuration ..... 34</p> <p>4.6 Heating Circuit Configuration ..... 35</p> <p>4.7 Domestic Hot Water Circuit Configuration ..... 37</p> <p><b>5 TECHNICAL SPECIFICATIONS ..... 39</b></p>
--	---

**NOTE : LEAVE THESE INSTRUCTIONS ADJACENT TO THE iCCS**

## CONTENTS - Figures

FIGURE 1 SINGLE BOILER WITH A CT PUMP CIRCUIT AND DHW TANK .....	14
FIGURE 2 SINGLE BOILER WITH 2 X CT PUMP CIRCUITS .....	14
FIGURE 3 SINGLE BOILER WITH CT AND HWS ZONE CIRCUITS .....	15
FIGURE 4 SINGLE BOILER WITH 2 X CT ZONE CIRCUITS .....	15
FIGURE 5 SEQUENCE CONTROL 1-16 BOILERS .....	16
FIGURE 6 SEQUENCE CONTROL 1-16 BOILERS WITH MIXING HEADER AND SYSTEM PUMP .....	16
FIGURE 7 SEQUENCE CONTROL 1-16 BOILERS WITH INDIRECT HOT WATER STORAGE TANK .....	16
FIGURE 8 SEQUENCE CONTROL 1-16 BOILERS WITH A CT PUMP CIRCUIT .....	17
FIGURE 9 SEQUENCE CONTROL 1-16 BOILERS WITH COMMON PUMP AND OPTIONAL VALVES .....	17
FIGURE 10 SEQUENCE CONTROL 1-16 BOILERS WITH LOCAL DHW DEMAND .....	17
FIGURE 11 SINGLE BOILER WITH A CT PUMP CIRCUIT AND DHW TANK .....	18
FIGURE 12 SINGLE BOILER WITH 2 X CT PUMP CIRCUITS .....	18
FIGURE 13 SINGLE BOILER WITH CT AND HWS ZONE CIRCUITS .....	18
FIGURE 14 SINGLE BOILER WITH CT AND HWS ZONE CIRCUITS .....	19
FIGURE 15 SEQUENCE CONTROL 1-16 BOILERS, BOILER N .....	20
FIGURE 16 SEQUENCE CONTROL 1-16 BOILERS, BOILER N WITH CT PUMP CIRCUIT .....	20
FIGURE 17 SEQUENCE CONTROL 1-16 BOILERS, BOILER N WITH CT PUMP AND INDIRECT HWS CIRCUIT .....	20
FIGURE 18 SEQUENCE CONTROL 1-16 BOILERS, BOILER N WITH 2 X CT PUMP CIRCUIT .....	20
FIGURE 19 EXTENSION MODULE WITH 1 X MIXING CIRCUIT .....	21
FIGURE 20 EXTENSION MODULE WITH 2 X MIXING CIRCUITS .....	21
FIGURE 21 EXTENSION MODULE WITH 1 X MIXING CIRCUIT AND 1 X CT PUMPED CIRCUIT .....	21
FIGURE 22 EXTENSION MODULE WITH 1 X MIXING CIRCUIT AND 1 X AIR HANDLER CIRCUIT .....	22
FIGURE 23 EXTENSION MODULE WITH 1 X MIXING CIRCUIT AND 1 X HWS CIRCUIT .....	22
FIGURE 24 EXTENSION MODULE WITH 2 X AIR HANDLER CIRCUITS .....	22
FIGURE 25 EXTENSION MODULE WITH 1 X CT PUMPED CIRCUIT AND 1 X HWS CIRCUIT .....	23
FIGURE 26 EXTENSION MODULE WITH 2 X HWS CIRCUIT .....	23
FIGURE 27 EXTENSION MODULE WITH MIXING CONTROL TO PLATE HEAT EXCHANGER FOR DIRECT HWS .....	23
FIGURE 28 EXTENSION MODULE WITH MIXING CONTROL TO PLATE HEAT EXCHANGER FOR DIRECT HWS WITH DHW PUMP .....	24
FIGURE 29 EXTENSION MODULE WITH MIXING CONTROL TO PLATE HEAT EXCHANGER FOR DIRECT DHW WITH PUMP .....	24
FIGURE 30 EXTENSION MODULE WITH PRIMARY BUFFER MIXING CONTROL TO PLATE HEAT EXCHANGER FOR DIRECT DHW WITH PUMP .....	24
FIGURE 31 VARICAN ADAPTOR DIAGRAM .....	25
FIGURE 32 EXTENSION MODULE DIAGRAM .....	25
FIGURE 33 SYSTEM MANAGER INTERFACE .....	28



## SCOPE

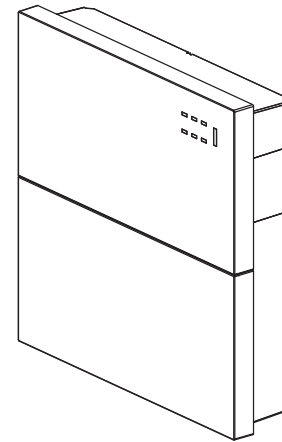
This document describes the iCCS Extension Module.  
The operation and configuration, through the iCCS compliant System Manager on the boiler, and the Installation of the module.

## COMPLIANCE

The control is an independent wall/DIN rail mounted enclosure for automatic temperature control of heating and/or DHW systems.  
The control is designed for continuous operation.

## INTRODUCTION

The Extension Module interfaces into the iCCS via the VariCAN bus that can be installed into any ICCS compatible boiler control system. The boiler requires a VariCAN Bus adapter to be fitted. The Bus can then be extended outside of the boiler and connected to up to four Extension Modules. Each Extension Module supports two Heating Circuits, DHW storage tanks with circulating pumps, or one DHW system. A combination of Heating Circuits and DHW storage tanks can be configured in any given Extension Module.  
Each heating circuit can be a Constant temperature circuit or a Variable temperature (Mixing) circuit, or an Air handling/blower unit.  
The single DHW system can be configured as a Primary buffer tank with mixing circuit via a plate heat exchanger, or a mixing circuit with a plate heat exchanger and a Secondary buffer tank. The system also supports a direct Hot Water System via a plate heat exchanger. All of these can also have DHW circulation pumps.



## DISPOSAL



Do not throw away this device as unsorted waste in the household trash. Return it to dedicated collection points for proper disposal. In this way you ensure an environmentally sound disposal and contribute to waste reduction according to the WEEE directive.

# 1 OPERATING GUIDE

## 1.1 Introduction

The control of the extension module is done via the Master Boiler System Manager. The configured extension module will be visible under the Heating Circuits and DHW Circuits menus.

The same sub-menu items will be available as shown in the iCCS system manual and are shown here for clarity.

## 1.2 Status LEDs

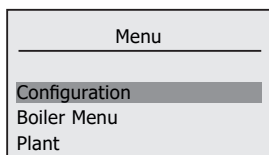
The unit has 7 status LEDs visible on the front panel. The LEDs numbered 1-6 show the operation of the outputs relating to the configured circuits, primarily for an EM configured with 2 circuits the LEDs are split into two groups of 3, 1-3 and 4-6, each of these shows the status of the configured outputs for each individual circuit. The LEDs will illuminate GREEN when the outputs are operating.

Where a complex HWS is configured, the full set of LEDs is used for this application. The Power/System status LED on the RHS shows the operational status of the EM, normally when powered up and with no errors this LED will be steady GREEN. If a fault exists it will turn to RED, the fault code will be displayed on the Master Boiler System Manager.

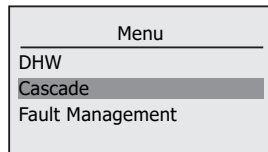
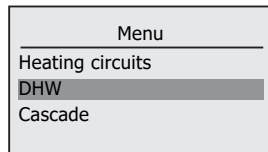
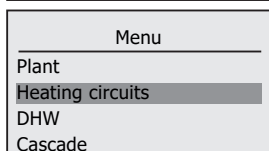
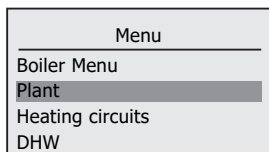
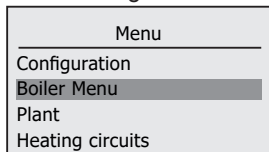
Note: Not all menu items or screens are shown depending upon the access level. The access level for this guide is Installer 2.

## 1.3 Menu

When any of the buttons are pressed or the knob rotated the display backlight will brighten up from its standby reduced level. To select the menu, press the 'Select' button, the menu will appear:



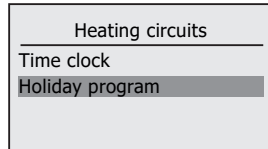
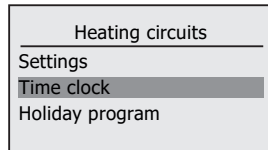
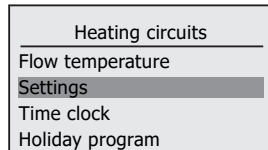
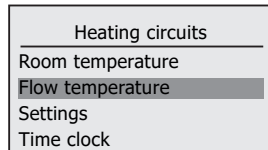
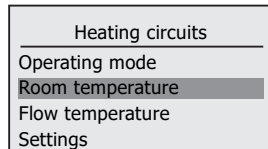
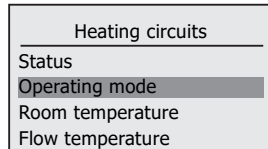
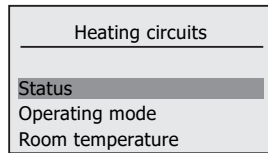
The menu can be scrolled down and contains the following items:



Note: Slave boilers do not have the Cascade menu option.

## 1.4 Menu – Heating Circuits

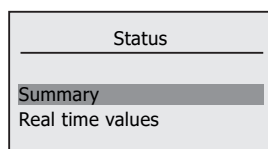
The heating circuits menu has the following options, there are other options but these are hidden from the User/Installer:



### 1.4.1 Menu – Heating Circuits - Status

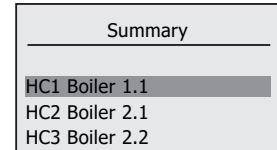
The status sub menu give you access to see the current real time values of the heating circuits.

The status menu has the following options:

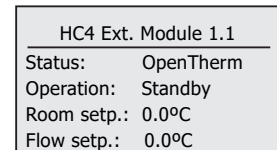
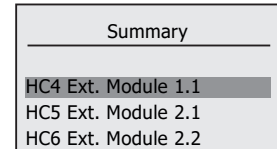


### 1.4.2 Menu – Heating Circuits – Status - Summary

The summary sub menu lists the configured heating circuits that are configured and can be selected, which then shows the main values for the heating circuit.

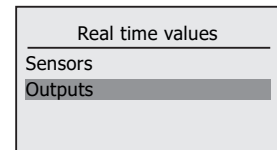
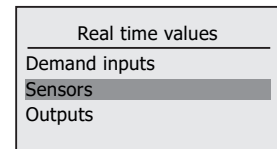
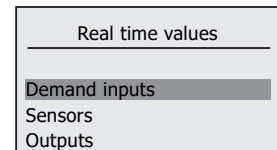


Depending on how many heating circuits are configured the Ext. Module heating circuits will appear in this scrolling list and can be selected:



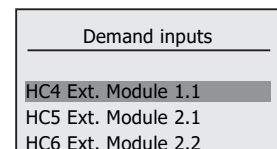
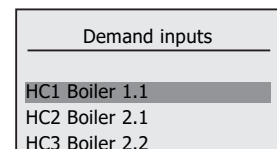
### 1.4.3 Menu – Heating Circuits – Status – Real Time Values

The Real time values menu has the following options:



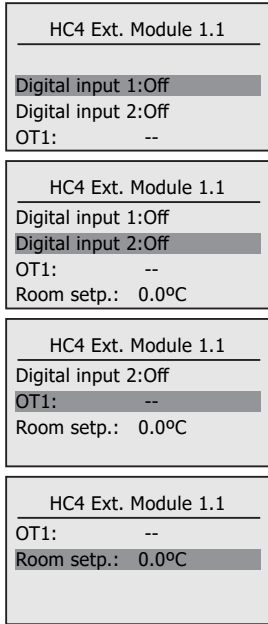
### 1.4.4 Menu – Heating Circuits – Status – Real Time Values – Demand Inputs

Once inputs is selected the screen will show the configured list of heating circuits:



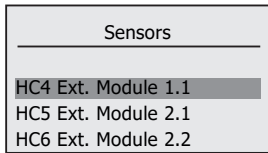
Once a heating circuit is selected, then the following screen will display the current

Real time values for the configured Inputs, once again items that are not configured will be shown with no value but with 2 dashes to indicate this, the list can be scrolled if required to show all values:

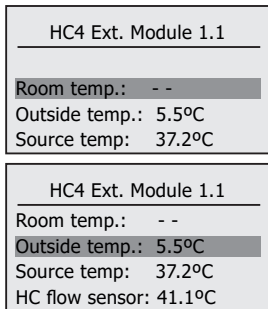


**1.4.5 Menu – Heating Circuits – Status – Real Time Values – Sensors**

Once sensors is selected the screen will show the configured list of heating circuits:

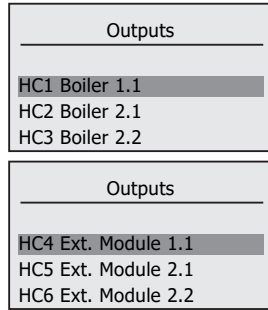


Once a heating circuit is selected, then the following screen will display the current Real time values for the configured sensors, once again items that are not configured will be shown with no value but with 2 dashes to indicate this, the list can be scrolled if required to show all values:

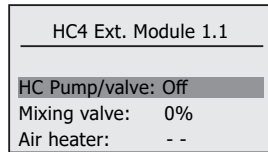


**1.4.6 Menu – Heating Circuits – Status – Real Time Values – Outputs**

Once outputs is selected the screen will show the configured list of heating circuits:

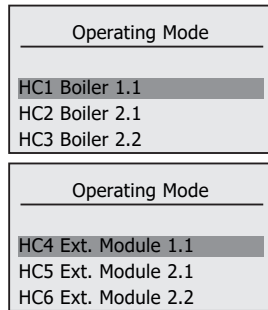


Once a heating circuit is selected, then the following screen will display the current Real time values for the configured outputs, once again items that are not configured will be shown with no value but with 2 dashes to indicate this, the list can be scrolled if required to show all values:

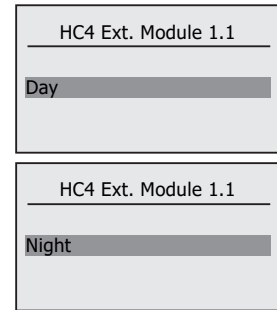
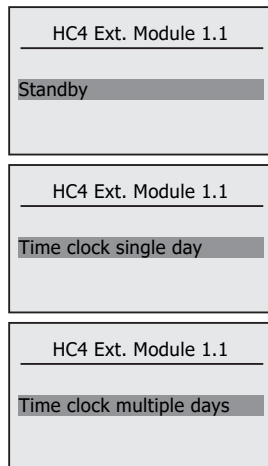


**1.4.7 Menu – Heating Circuit – Operating Mode**

Each heating circuit operating mode can be set. This controls the operation of the selected HC.



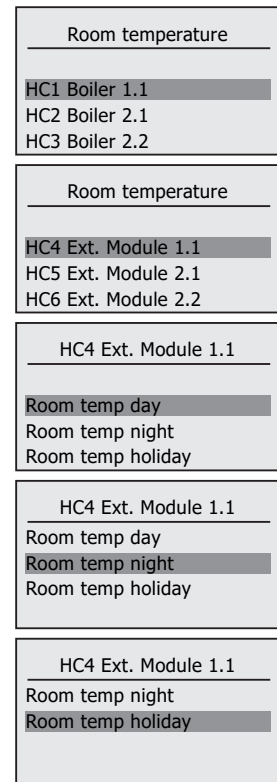
The options are:



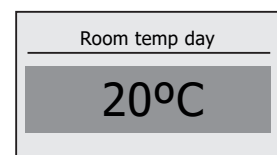
Standby – Frost protection only  
 Time clock single day – Normal operation, timed  
 Time clock multiple day – Normal operation, timed  
 Day – Normal operation, continuous day mode  
 Night – Normal operation, continuous night mode.

**1.4.8 Menu – Heating Circuit – Room Temperature**

Each heating circuit target room temperature can be set for different operating modes for the selected HC.



Each selected room temperature set point can be adjusted and then set, the adjustment screen is left by pressing the back button:



### 1.4.9 Menu – Heating Circuit – Flow Temperature

Each heating circuit flow temperature can be set for different operating modes for the selected HC.

Flow temperature
HC1 Boiler 1.1
HC2 Boiler 2.1
HC3 Boiler 2.2

Flow temperature
HC4 Ext. Module 1.1
HC5 Ext. Module 2.1
HC6 Ext. Module 2.2

HC4 Ext. Module 1.1
Flow temp day
Flow temp night
Flow temp holiday

HC4 Ext. Module 1.1
Flow temp day
Flow temp night
Flow temp holiday

HC4 Ext. Module 1.1
Flow temp night
Flow temp holiday

Each selected flow temperature set point can be adjusted and then set, the adjustment screen is left by pressing the back button:

Flow temp day
60°C

This limits the flow temperature into a HC.

### 1.4.10 Menu – Heating Circuit – Settings

Each heating circuit has a number of settings that can be adjusted for the selected HC.

Settings
HC1 Boiler 1.1
HC2 Boiler 2.1
HC3 Boiler 2.2

Settings
HC4 Ext. Module 1.1
HC5 Ext. Module 2.1
HC6 Ext. Module 2.2

HC4 Ext. Module 1.1
Preheat
Heating limit
Room temp. switch diff.

HC4 Ext. Module 1.1
Preheat
Heating limit
Room temp. switch diff.
Pump

HC4 Ext. Module 1.1
Heating limit
Room temp. switch diff.
Pump
Heating curve

HC4 Ext. Module 1.1
Room temp. switch diff.
Pump
Heating curve
PIDs

HC4 Ext. Module 1.1
Pump
Heating curve
PIDs
Frost protection

HC4 Ext. Module 1.1
Heating curve
PIDs
Frost protection

HC4 Ext. Module 1.1
PIDs
Frost protection

### 1.4.11 Menu – Heating Circuit – Settings - Preheat

This controls the preheat compensation for a given heating circuit, if enabled this will bring on demand from that heating circuit prior to an increase in temperature set point. E.g. from night to day mode. The time allowed for preheat is limited by the Maximum preheat time, this ensures that the heating circuit demand can only start within that time value and not start any earlier.

Preheat can be enabled for the selected HC and the maximum allowable preheat time set.

Preheat
Preheat switch
Maximum preheat time

Preheat
On/Off <input type="checkbox"/>

Preheat
On/Off <input checked="" type="checkbox"/>

Preheat
Preheat switch
Maximum preheat time

Preheat
120minutes

### 1.4.12 Menu – Heating Circuit – Settings – Heating Limit

This ensures that the heating is not switched on unnecessarily if the average outside temperature, e.g. during the summer months, is higher than the room temperature setpoint in day mode.

Heating limit can be enabled for the selected HC and the heating limit temperature setpoint defined.

Heating limit switch
On/Off <input type="checkbox"/>

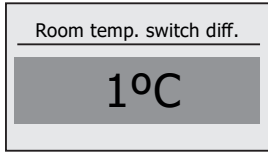
Heating limit switch
On/Off <input checked="" type="checkbox"/>

Heating limit temperature
19°C



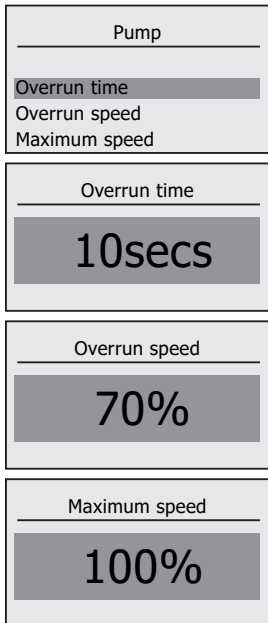
**1.4.13 Menu – Heating Circuit – Settings – Room Temp. Switch Diff.**

This sets the switching differential for the HC room sensor. The value ensures that the HC does not continuously cycle demand into the system.



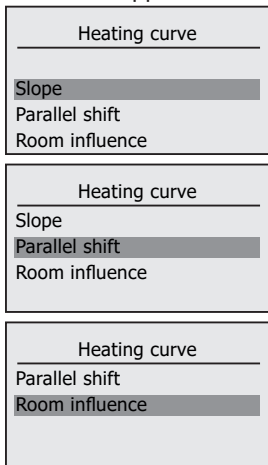
**1.4.14 Menu – Heating Circuit – Settings – Pump**

The pump for each individual heating circuit has a number of settings. Some relate to speed if configured for control by a 0-10V output.



**1.4.15 Menu - Heating Circuit - Settings - Heating Curve**

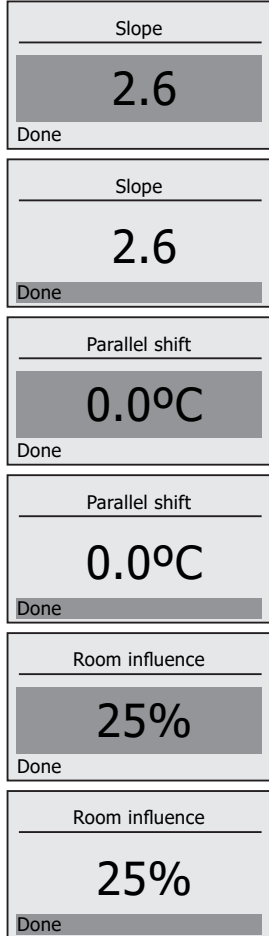
The heating curve parameters can be adjusted to suit the application if required.



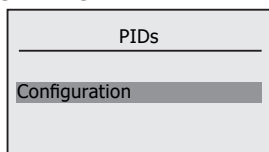
The slope of the curve has a default setting of 2.60 can be adjusted between 0.25 and 4.00, see the associated data sheet for example curves. This slope contributes to the adjustments of the flow set point in relation to the outside temperature.

The curve parallel shift has a default setting of 0.0°C, and this can be adjusted between -50.0°C and 50.0°C. This offset adjusts the curve vertically.

The room influence factor has a default setting of 25% and can be adjusted between 0 and 100%. The room influence proportions the effect between outside temperature and room temperature on the flow set point.



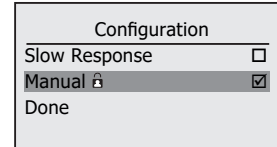
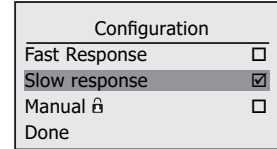
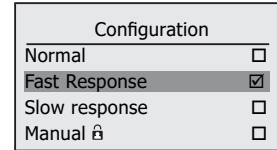
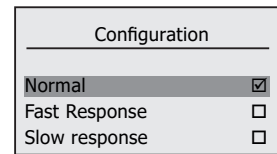
**1.4.16 Menu - Heating Circuit - Settings - PIDs**



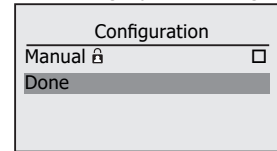
The plant cascade control PIDs can be set to compensate for any performance related issues that are caused by the Hydraulic design of the system, the Normal set are optimised for the standard frame and header installation.

The PIDs can be adjusted by the Installer (Level 2) to be Faster or Slower in response time to the Normal settings. These Faster and Slower settings are tolerance within 10% of the nominal values.

For hydraulic systems that cause a faster load capacity change in the header then the Faster response time PIDs should be selected, for a hydraulic system which causes a slower load capacity change, then the Slower response time PIDs should be selected.

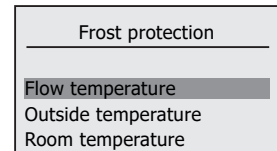


Once the setting has been selected, confirm this setting by selectong done.



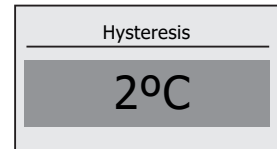
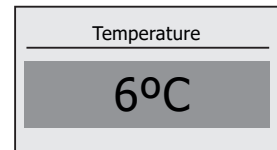
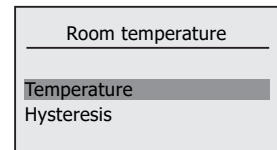
**1.4.17 Menu – Heating Circuit – Settings – Frost Protection**

Heating circuit frost protection operation can be triggered by a number of measured real time values:

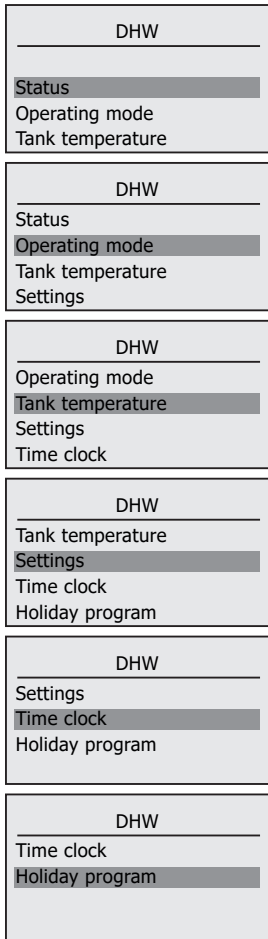


Each of these has a trigger set point and a hysteresis value above which the function is once again deactivated.

E.g. Room temperature, if the actual room temperature drops below the temperature setpoint value then HC will create a demand into the system. It will only remove this demand once the actual room temperature has risen above this value, plus the hysteresis setting.



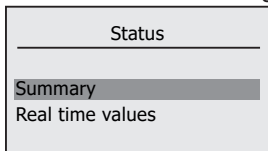
## 1.5 Menu – DHW



### 1.5.1 Menu – DHW - Status

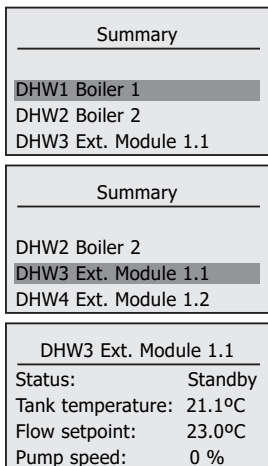
The status sub menu give you access to see the current real time values of the DHW circuits.

The status menu has the following options:



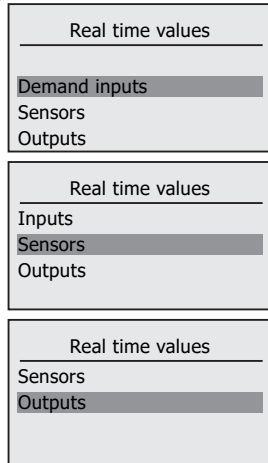
### 1.5.2 Menu – DHW – Status - Summary

The summary sub menu lists the configured DHW circuits that are configured and can be selected, which then shows the main values for the DHW circuit.



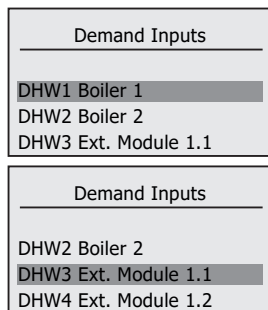
### 1.5.3 Menu – DHW – Status – Real Time Values

The Real time values menu has the following options:

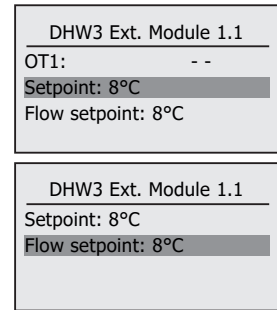
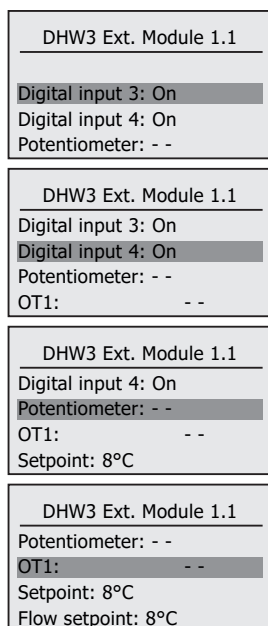


### 1.5.4 Menu – DHW – Status – Real Time Values – Demand Inputs

Once inputs is selected the screen will show the configured list of DHW circuits:

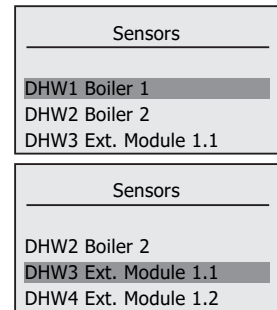


Once a DHW circuit is selected, then the following screen will display the current Real time values for the configured Inputs, once again items that are not configured will be shown with no value but with 2 dashes to indicate this, the list can be scrolled if required to show all values:

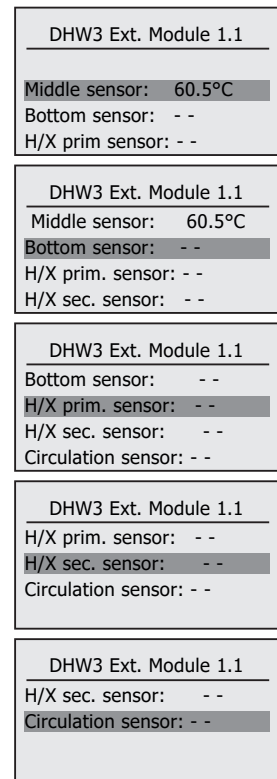


### 1.5.5 Menu – DHW – Status – Real Time Values – Sensors

Once sensors is selected the screen will show the configured list of DHW circuits:



Once a DHW circuit is selected, then the following screen will display the current Real time values for the configured sensors, once again items that are not configured will be shown with no value but with 2 dashes to indicate this, the list can be scrolled if required to show all values:



### 1.5.6 Menu – DHW – Status – Real Time Values – Outputs

Once outputs is selected the screen will show the configured list of DHW circuits:

Outputs
DHW1 Boiler 1
DHW2 Boiler 2
DHW3 Ext. Module 1.1

Outputs
DHW2 Boiler 2
DHW3 Ext. Module 1.1
DHW4 Ext. Module 1.2

Once a DHW circuit is selected, then the following screen will display the current Real time values for the configured outputs, once again items that are not configured will be shown with no value but with 2 dashes to indicate this, the list can be scrolled if required to show all values:

DHW3 Ext. Module 1.1
DHW pump/valve: Off
Primary pump: - -
Secondary pump: - -

DHW3 Ext. Module 1.1
DHW pump/valve: Off
Primary pump: - -
Secondary pump: - -
Mixing valve: - -

DHW3 Ext. Module 1.1
Primary pump: - -
Secondary pump: - -
Mixing valve: - -
Circulation pump: Off

DHW3 Ext. Module 1.1
Secondary pump: - -
Mixing valve: - -
Circulation pump: Off

DHW3 Ext. Module 1.1
Mixing valve: - -
Circulation pump: Off

### 1.5.7 Menu – DHW – Operating Mode

Each DHW circuit operating mode can be set. This controls the operation of the selected DHW circuit.

Operation Mode
DHW1 Boiler 1
DHW2 Boiler 2
DHW3 Ext. Module 1.1

Operation Mode
DHW2 Boiler 2
DHW3 Ext. Module 1.1
DHW4 Ext. Module 1.2

The options are:

DHW3 Ext. Module 1.1
Standby

DHW3 Ext. Module 1.1
Time clock single day

DHW3 Ext. Module 1.1
Time clock multiple days

DHW3 Ext. Module 1.1
Day

DHW3 Ext. Module 1.1
Night

Standby – Frost protection only  
 Time clock single day – Normal operation, timed  
 Time clock multiple day – Normal operation, timed

### 1.5.8 Menu – DHW – Temperature

Each DHW circuit target temperature can be set for different operating modes for the selected DHW circuit.

Temperature
DHW1 Boiler 1
DHW2 Boiler 2
DHW3 Ext. Module 1.1

Temperature
DHW2 Boiler 2
DHW3 Ext. Module 1.1
DHW4 Ext. Module 1.2

Each selected temperature set point can be adjusted and then set, the adjustment screen is left by pressing the back button:

Temp day
65°C

Temp night
10°C

Temp holiday
10°C

### 1.5.9 Menu – DHW – Settings

Each DHW circuit has a number of settings that can be adjusted for the selected DHW circuit.

Settings
DHW1 Boiler 1
DHW2 Boiler 2
DHW3 Ext. Module 1.1

Settings
DHW2 Boiler 2
DHW3 Ext. Module 1.1
DHW4 Ext. Module 1.2

DHW3 Ext. Module 1.1
One time boost
Charge pump
Prim./sec. pump

DHW3 Ext. Module 1.1
One time boost
Charge pump
Prim./sec. pump
Legionella

DHW3 Ext. Module 1.1
Charge pump
Prim./sec. pump
Legionella
Frost protection

DHW3 Ext. Module 1.1
Prim./sec. pump
Legionella
Frost protection
Early start DHW storage

DHW3 Ext. Module 1.1
Legionella
Frost protection
Early start DHW storage

DHW3 Ext. Module 1.1
Frost protection
Early start DHW storage

### 1.5.10 Menu – DHW – Settings – One Time Boost

Each DHW circuit can have a one-time boost to allow for out of hours hot water requirements. The boost can be enabled and a tank temperature set for this function.

On/Off
One time boost <input type="checkbox"/>

On/Off
One time boost <input checked="" type="checkbox"/>

Temperature
60°C

### 1.5.11 Menu – DHW – Settings – Pump

The pumps for each individual DHW circuit have a number of settings. Some relate to speed if configured for control by a 0-10V output.

Charge pump
Overrun time
Overrun speed
Minimum speed

Charge pump
Overrun time
Overrun speed
Minimum speed
Maximum speed

Charge pump
Overrun speed
Minimum speed
Maximum speed

Charge pump
Minimum speed
Maximum speed

Overrun time
10secs
Done

Overrun time
10secs
Done

Overrun speed
50%
Done

Overrun speed
50%
Done

Minimum speed
10%
Done

Minimum
10%
Done

Maximum speed
100%
Done

Maximum speed
100%
Done

Prim./sec. pump
Prim./sec. pump overrun

Prim./sec. pump
240secs
Done

Prim./sec. pump
240secs
Done

### 1.5.12 Menu – DHW – Settings – Legionella

Two modes of operation of the function for Anti-legionella exist in the system. They can be selected and the parameters adjusted.

Legionella
Operation mode
Temperature
One time run

OR

Legionella
Operation mode
Temperature
Interval

OR

Legionella
Operation mode
Temperature
Weekday and time

The operating mode options are:

Operation Mode
None

Operation Mode
Weekday

Operation Mode
Interval

Weekday – set the weekday and time of operation

Interval- sets the interval between operation

The mode of operation when set changes the last menu option to set the parameter controlling the anti-legionella event. Both modes require a temperature setpoint.

Temperature
65°C
Done

Interval
7day(s)
Done

Weekday and time
Weekday: Saturday
Start time: 01:00

### 1.5.13 Menu – DHW – Settings – Frost Protection

Frost protection
DHW minimum flow

DHW minimum flow
8°C
Done

### 1.5.14 Menu – DHW – Settings – Early Start DHW Storage

Each DHW circuit can have an early start prior to Day mode. This allows the tank to be charged prior to normal day time by starting storage at a defined number of minutes earlier.

Early start DHW storage
0minutes

### 1.5.15 Menu – DHW – Time Clock

Each DHW circuit can have its own individual time programme. Refer to the Plant section for guidance on how this is set.

### 1.5.16 Menu – DHW – Holiday Programme

Each DHW circuit can have its own individual holiday programmes. Refer to the Plant section for guidance on how this is set.













# PARTIAL HYDRAULICS - Continued

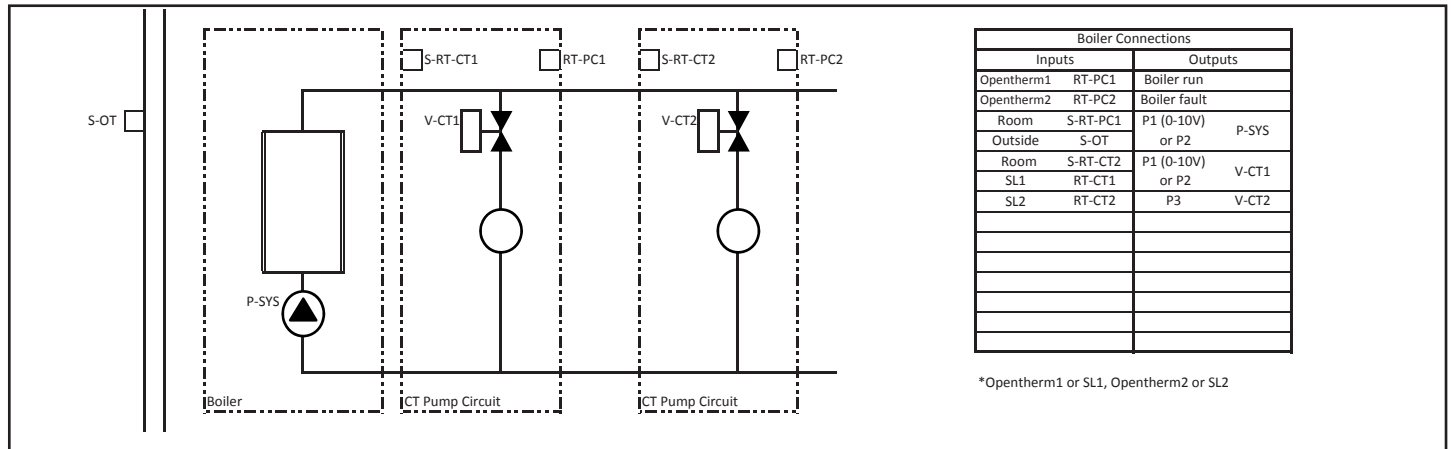


FIGURE 14 SINGLE BOILER WITH CT AND HWS ZONE CIRCUITS

# PARTIAL HYDRAULICS - Boiler n Slave Configuration Options

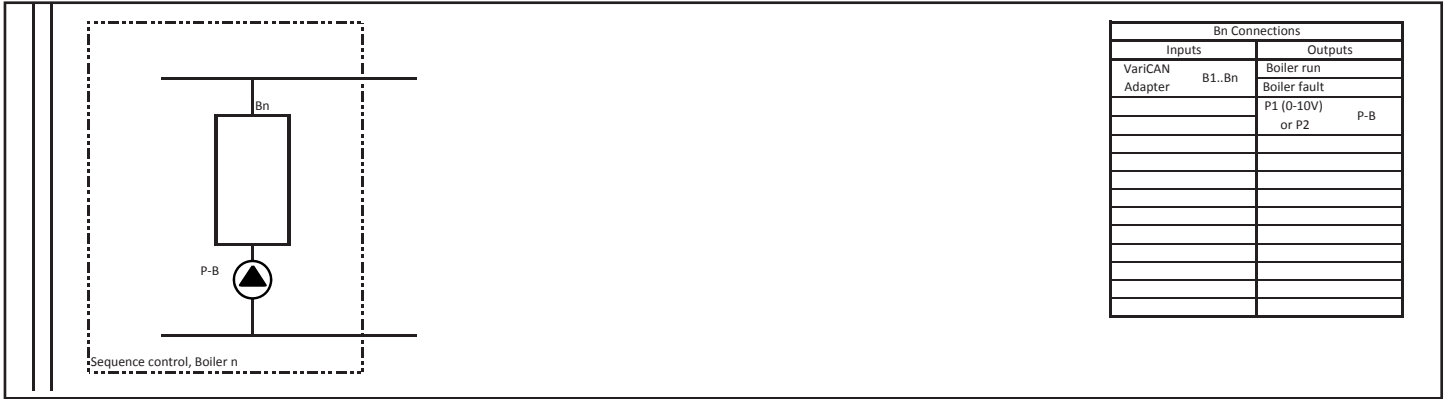


FIGURE 15 SEQUENCE CONTROL 1-16 BOILERS, BOILER N

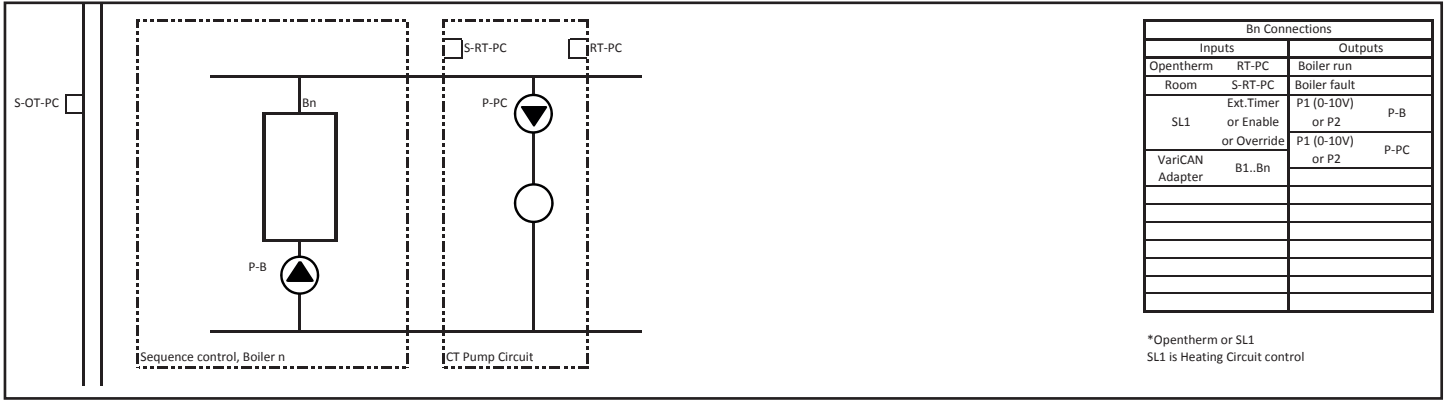


FIGURE 16 SEQUENCE CONTROL 1-16 BOILERS, BOILER N WITH CT PUMP CIRCUIT

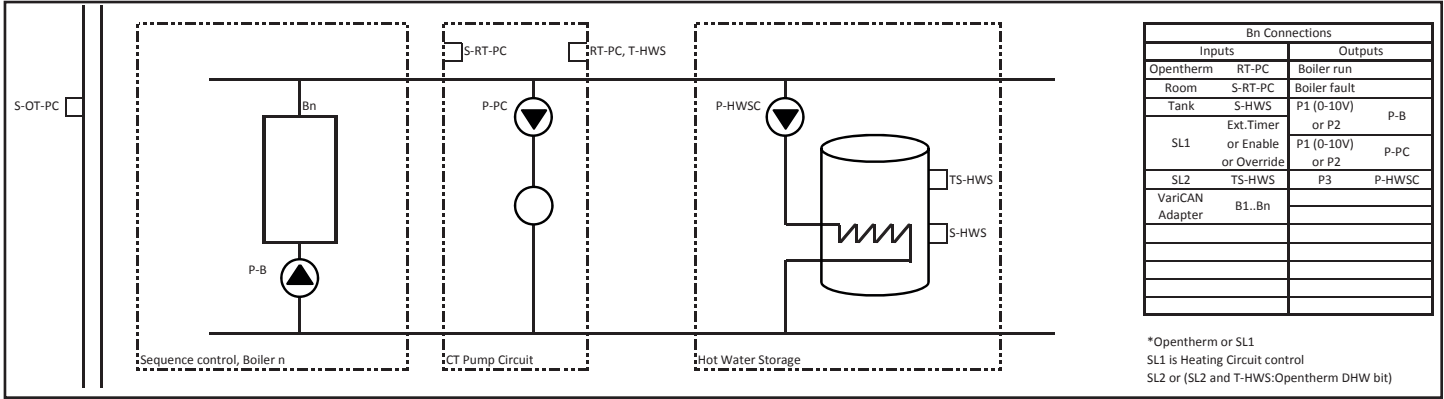


FIGURE 17 SEQUENCE CONTROL 1-16 BOILERS, BOILER N WITH CT PUMP AND INDIRECT HWS CIRCUIT

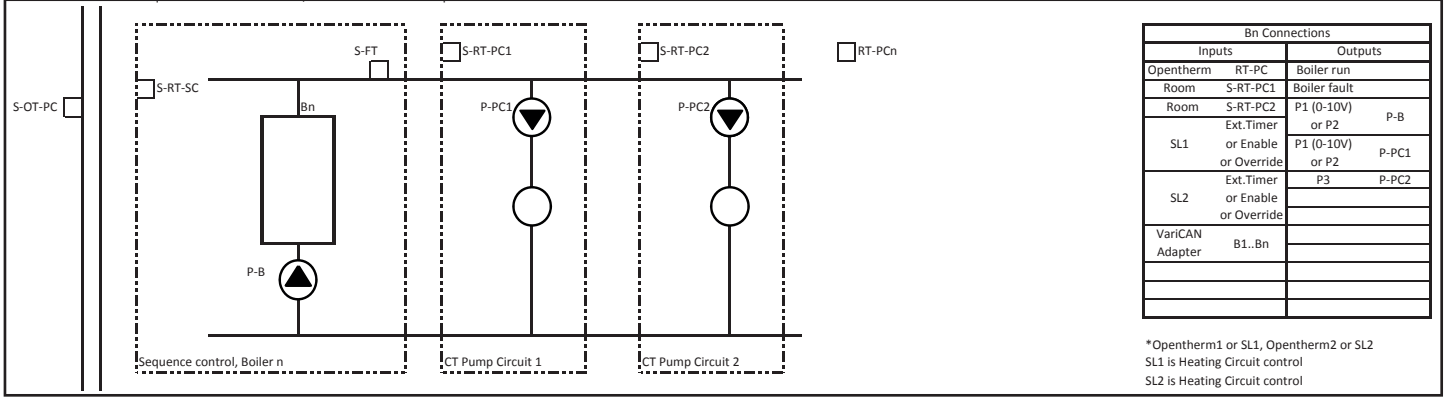


FIGURE 18 SEQUENCE CONTROL 1-16 BOILERS, BOILER N WITH 2 X CT PUMP CIRCUIT

# PARTIAL HYDRAULICS - Extension Module Configuration Options

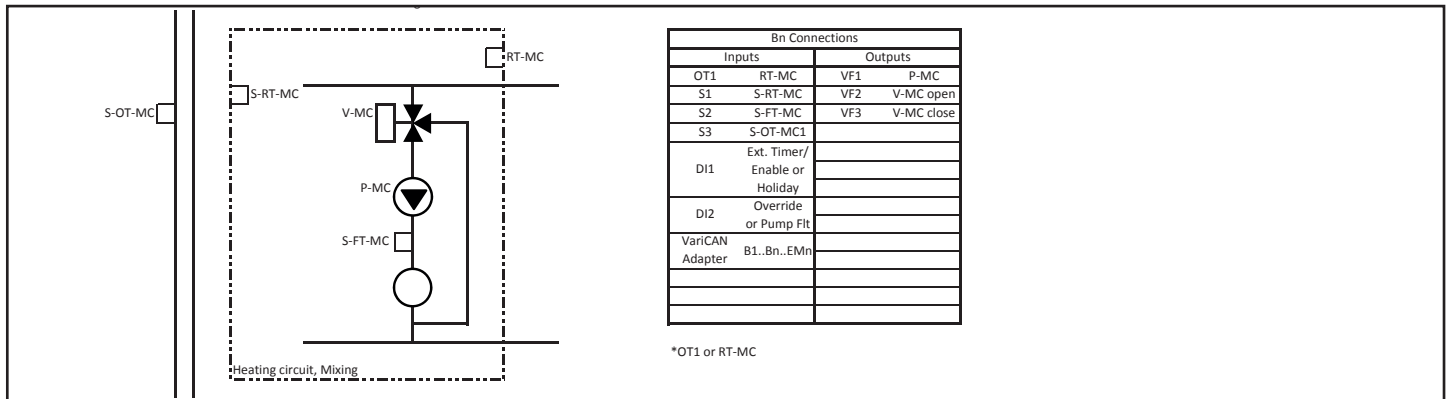


FIGURE 19 EXTENSION MODULE WITH 1 X MIXING CIRCUIT

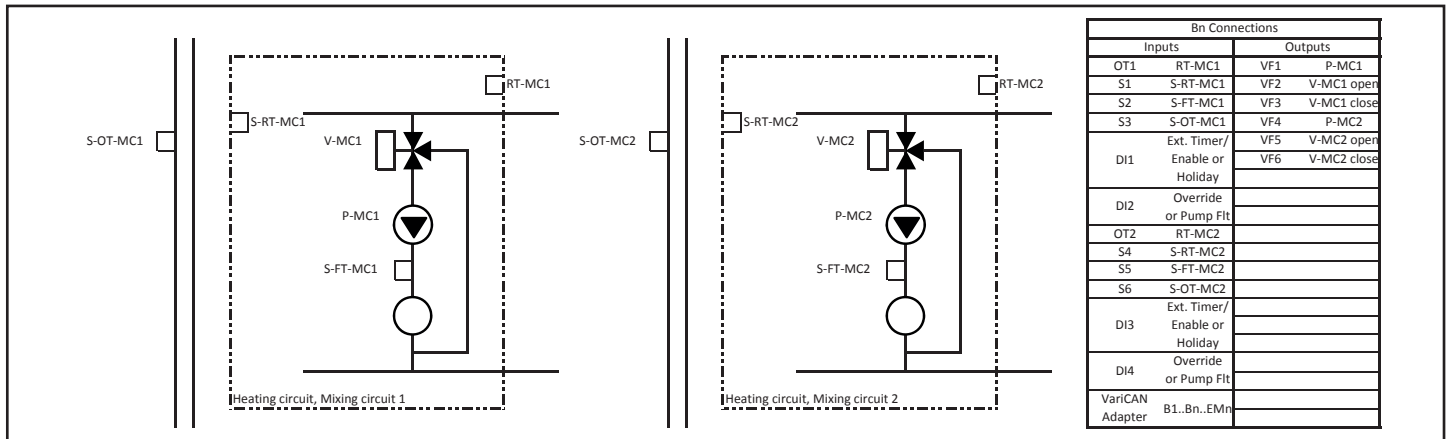


FIGURE 20 EXTENSION MODULE WITH 2 X MIXING CIRCUITS

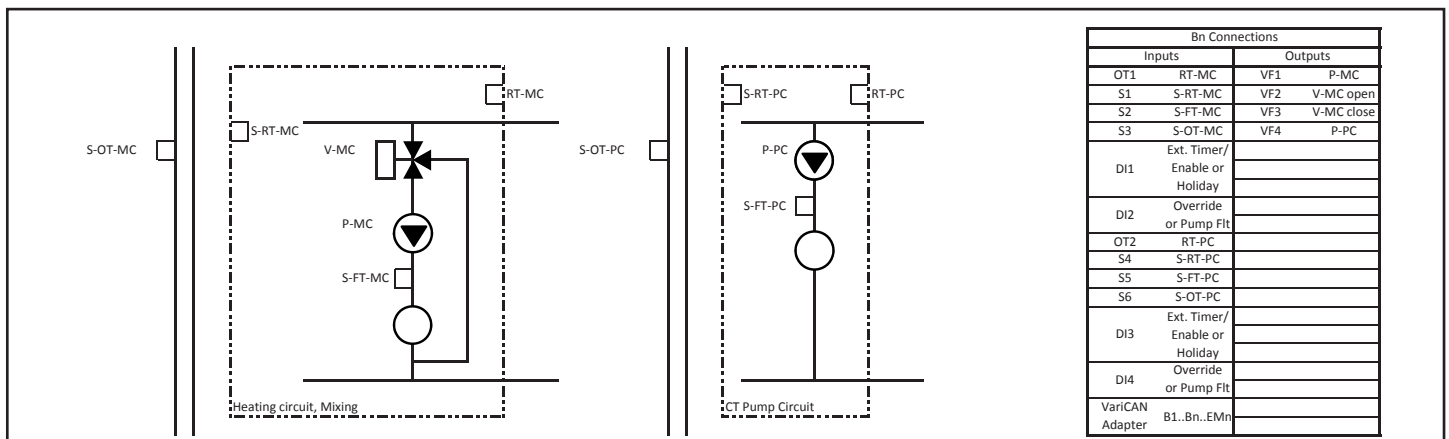


FIGURE 21 EXTENSION MODULE WITH 1 X MIXING CIRCUIT AND 1 X CT PUMPED CIRCUIT

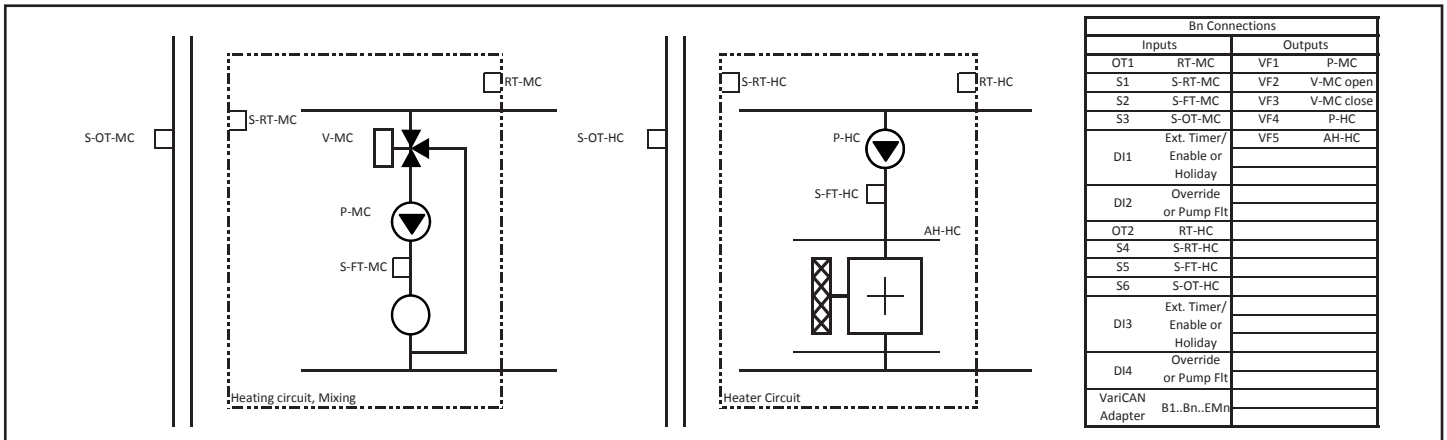


FIGURE 22 EXTENSION MODULE WITH 1 X MIXING CIRCUIT AND 1 X AIR HANDLER CIRCUIT

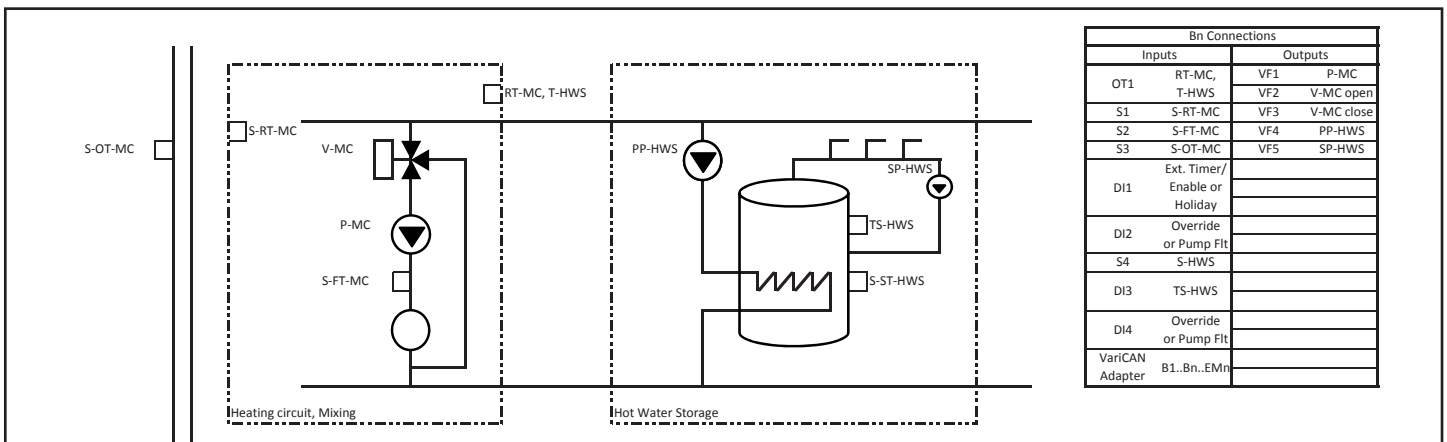


FIGURE 23 EXTENSION MODULE WITH 1 X MIXING CIRCUIT AND 1 X HWS CIRCUIT

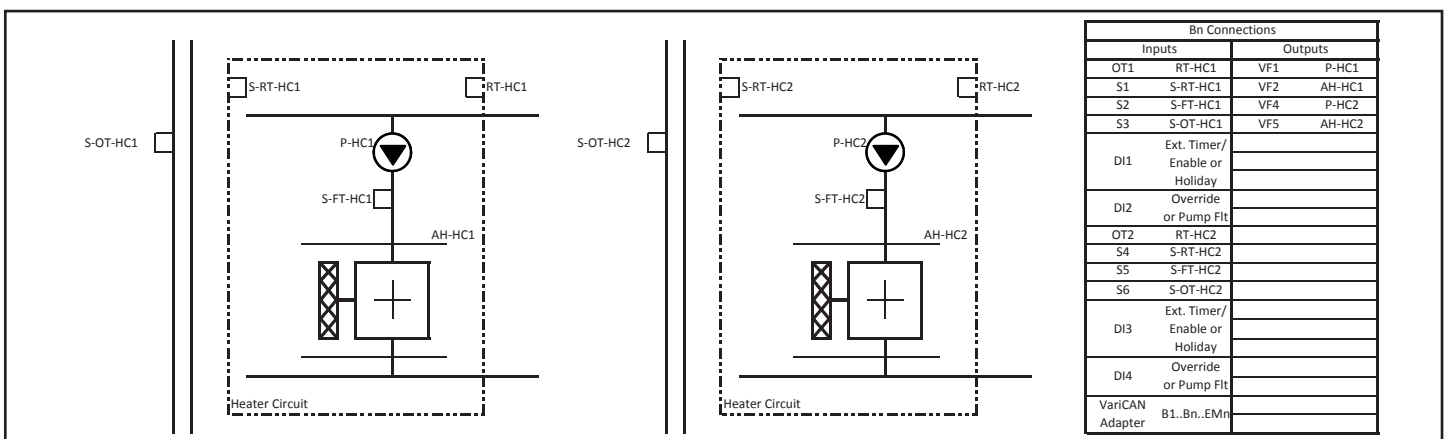
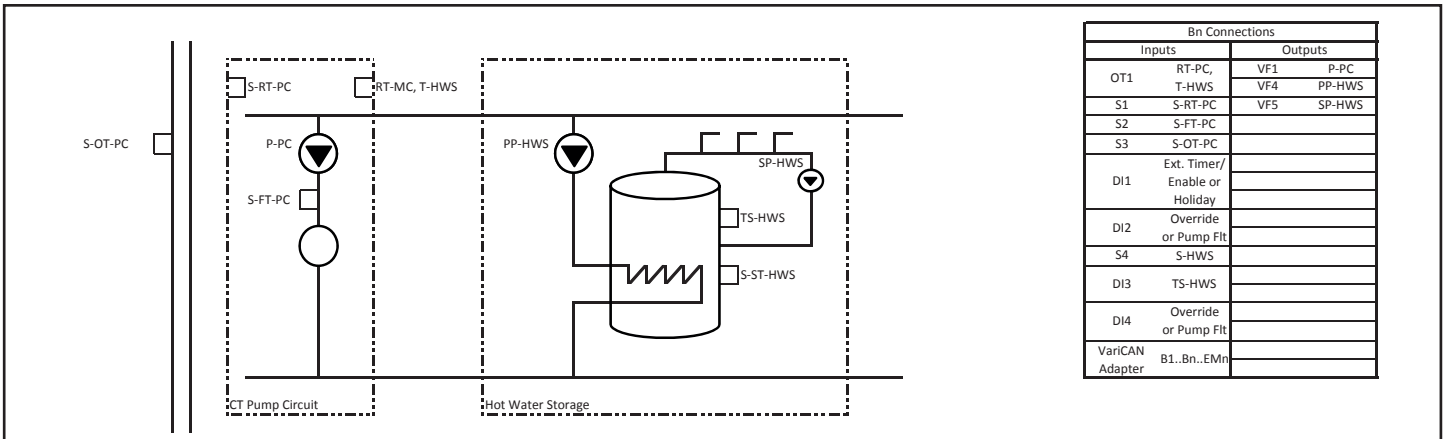
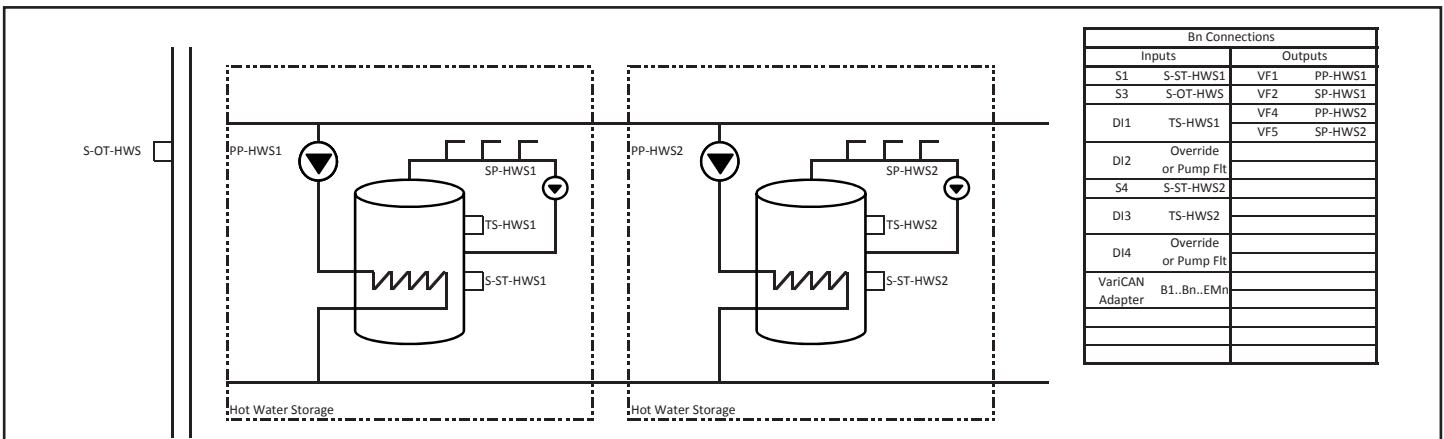


FIGURE 24 EXTENSION MODULE WITH 2 X AIR HANDLER CIRCUITS

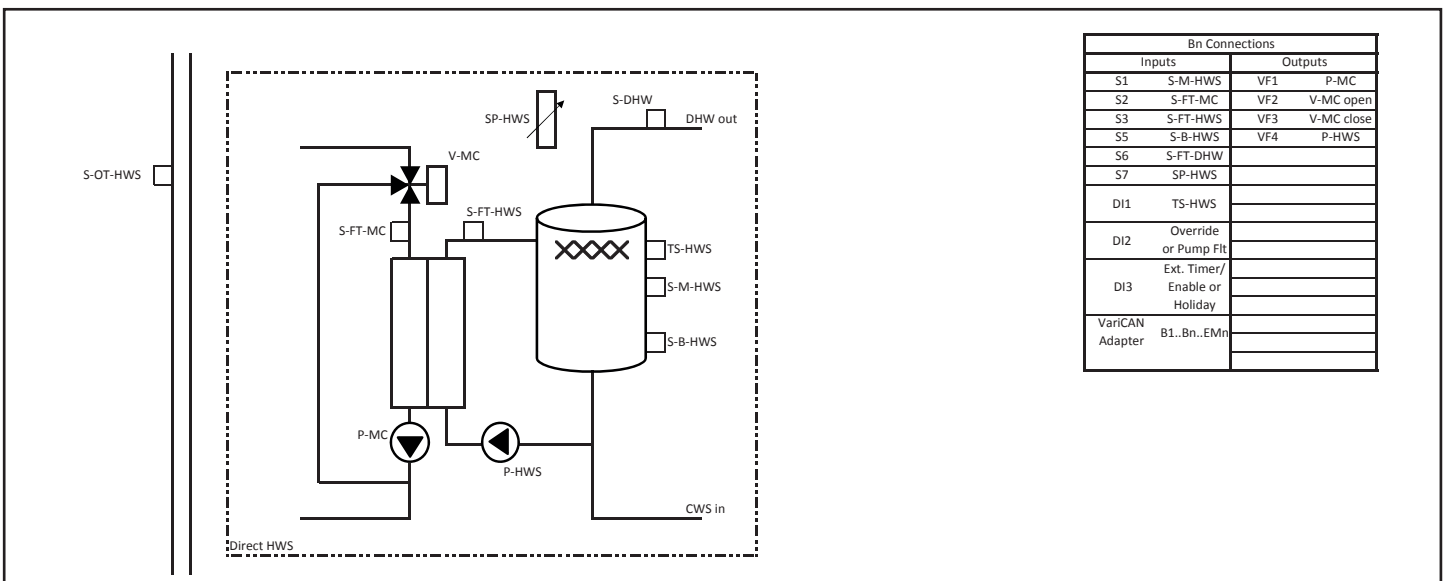
# PARTIAL HYDRAULICS - Extension Module Configuration Options Continued



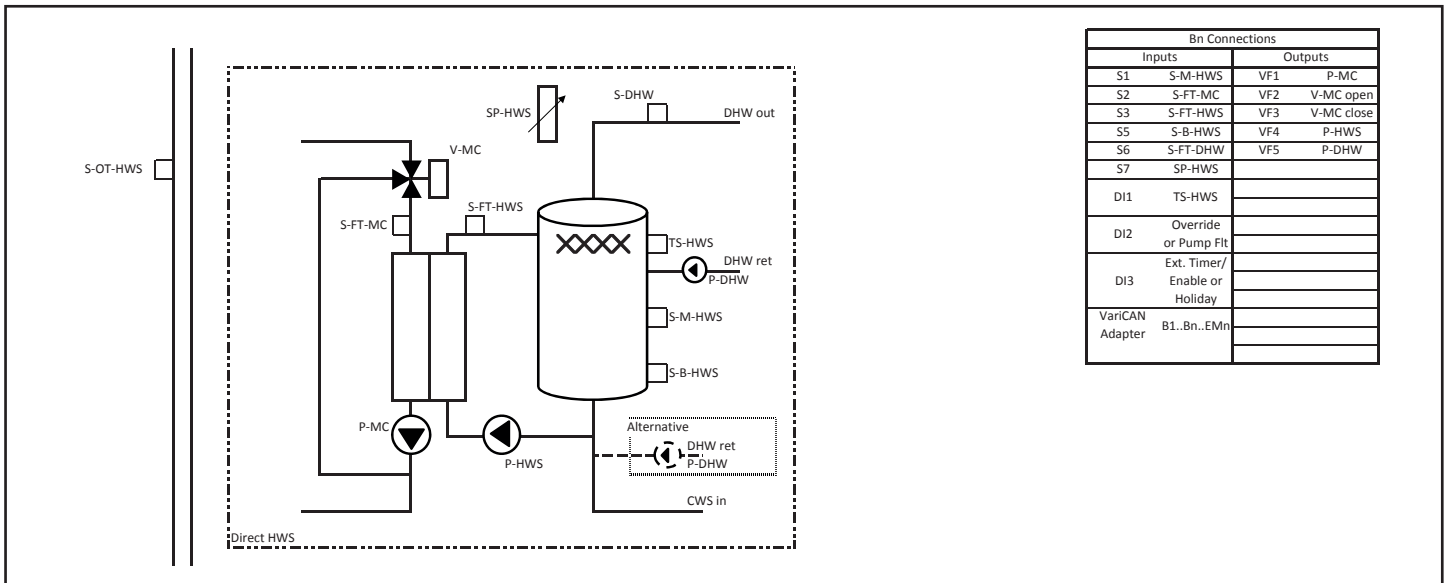
**FIGURE 25 EXTENSION MODULE WITH 1 X CT PUMPED CIRCUIT AND 1 X HWS CIRCUIT**



**FIGURE 26 EXTENSION MODULE WITH 2 X HWS CIRCUIT**

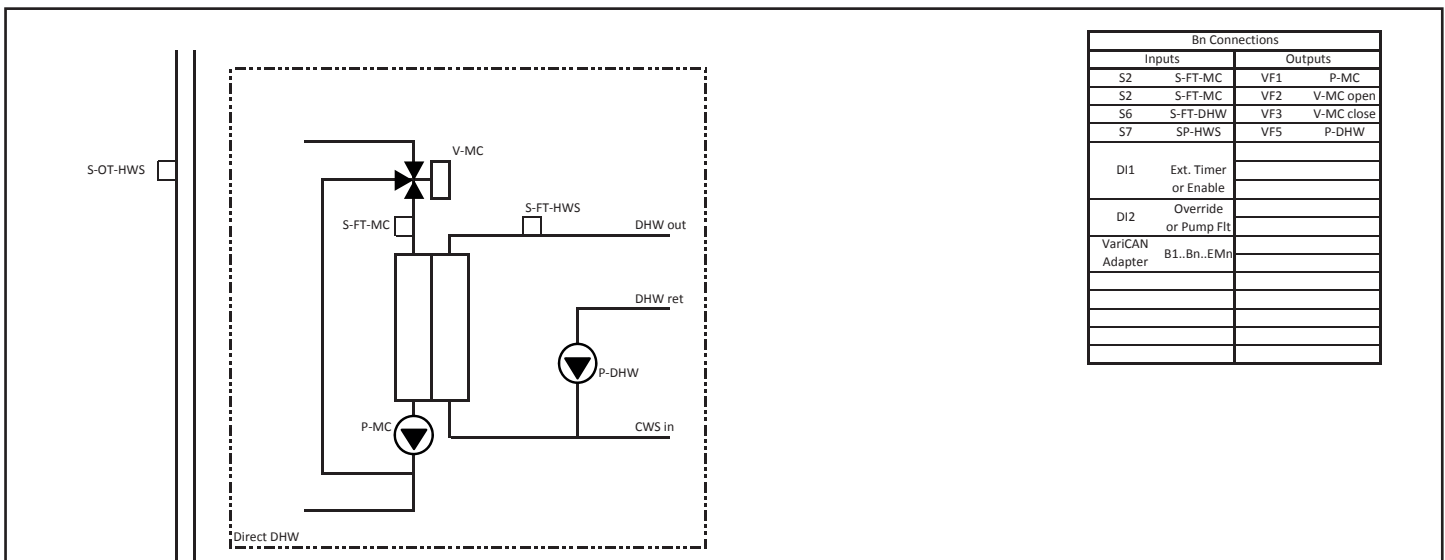


**FIGURE 27 EXTENSION MODULE WITH MIXING CONTROL TO PLATE HEAT EXCHANGER FOR DIRECT HWS**



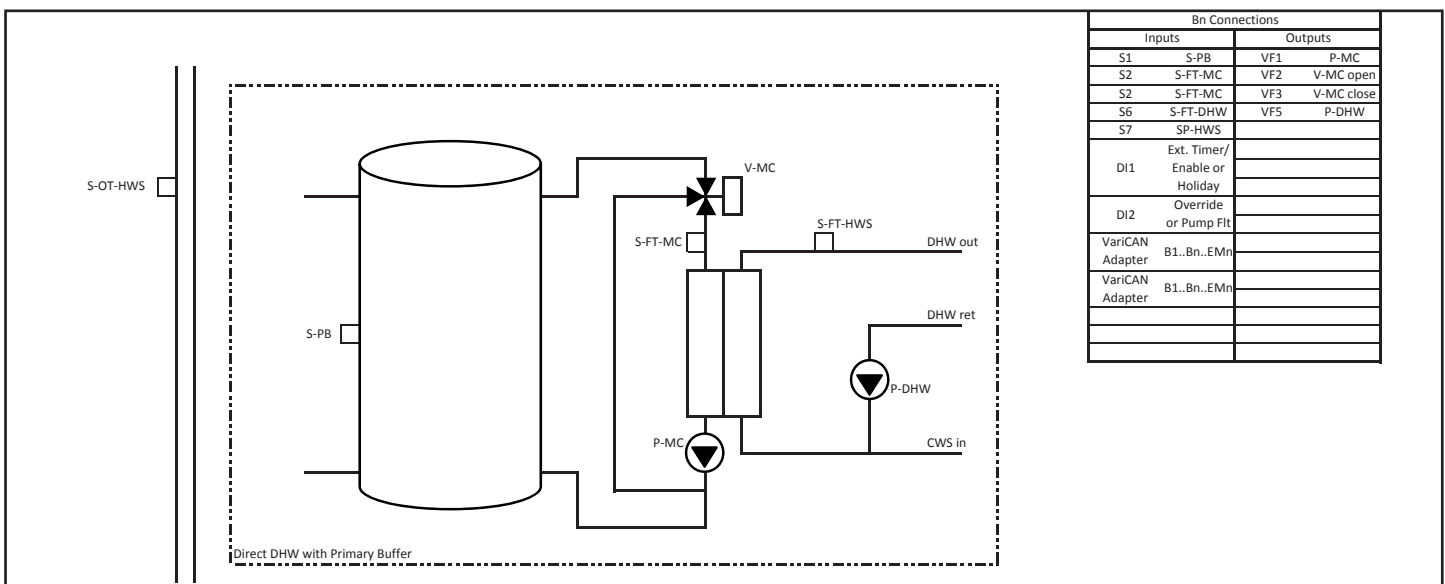
Bn Connections			
Inputs		Outputs	
S1	S-M-HWS	VF1	P-MC
S2	S-FT-MC	VF2	V-MC open
S3	S-FT-HWS	VF3	V-MC close
S5	S-B-HWS	VF4	P-HWS
S6	S-FT-DHW	VF5	P-DHW
S7	SP-HWS		
DI1	TS-HWS		
DI2	Override or Pump Flt		
DI3	Ext. Timer/ Enable or Holiday		
VariCAN Adapter	B1..Bn..EMn		

**FIGURE 28 EXTENSION MODULE WITH MIXING CONTROL TO PLATE HEAT EXCHANGER FOR DIRECT HWS WITH DHW PUMP**



Bn Connections			
Inputs		Outputs	
S2	S-FT-MC	VF1	P-MC
S2	S-FT-MC	VF2	V-MC open
S6	S-FT-DHW	VF3	V-MC close
S7	SP-HWS	VF5	P-DHW
DI1	Ext. Timer/ Enable or Enable		
DI2	Override or Pump Flt		
VariCAN Adapter	B1..Bn..EMn		

**FIGURE 29 EXTENSION MODULE WITH MIXING CONTROL TO PLATE HEAT EXCHANGER FOR DIRECT DHW WITH PUMP**



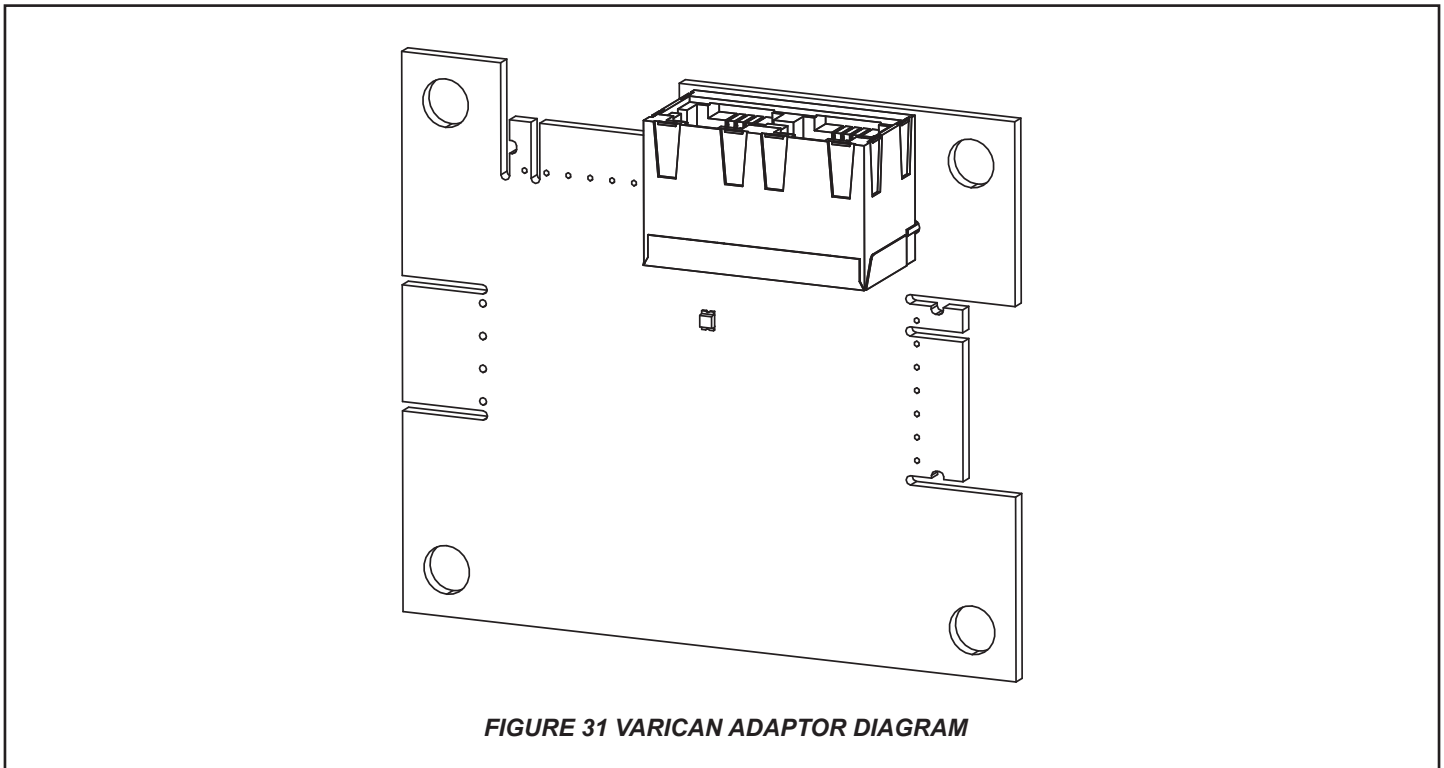
Bn Connections			
Inputs		Outputs	
S1	S-PB	VF1	P-MC
S2	S-FT-MC	VF2	V-MC open
S2	S-FT-MC	VF3	V-MC close
S6	S-FT-DHW	VF5	P-DHW
S7	SP-HWS		
DI1	Ext. Timer/ Enable or Holiday		
DI2	Override or Pump Flt		
VariCAN Adapter	B1..Bn..EMn		
VariCAN Adapter	B1..Bn..EMn		

**FIGURE 30 EXTENSION MODULE WITH PRIMARY BUFFER MIXING CONTROL TO PLATE HEAT EXCHANGER FOR DIRECT DHW WITH PUMP**

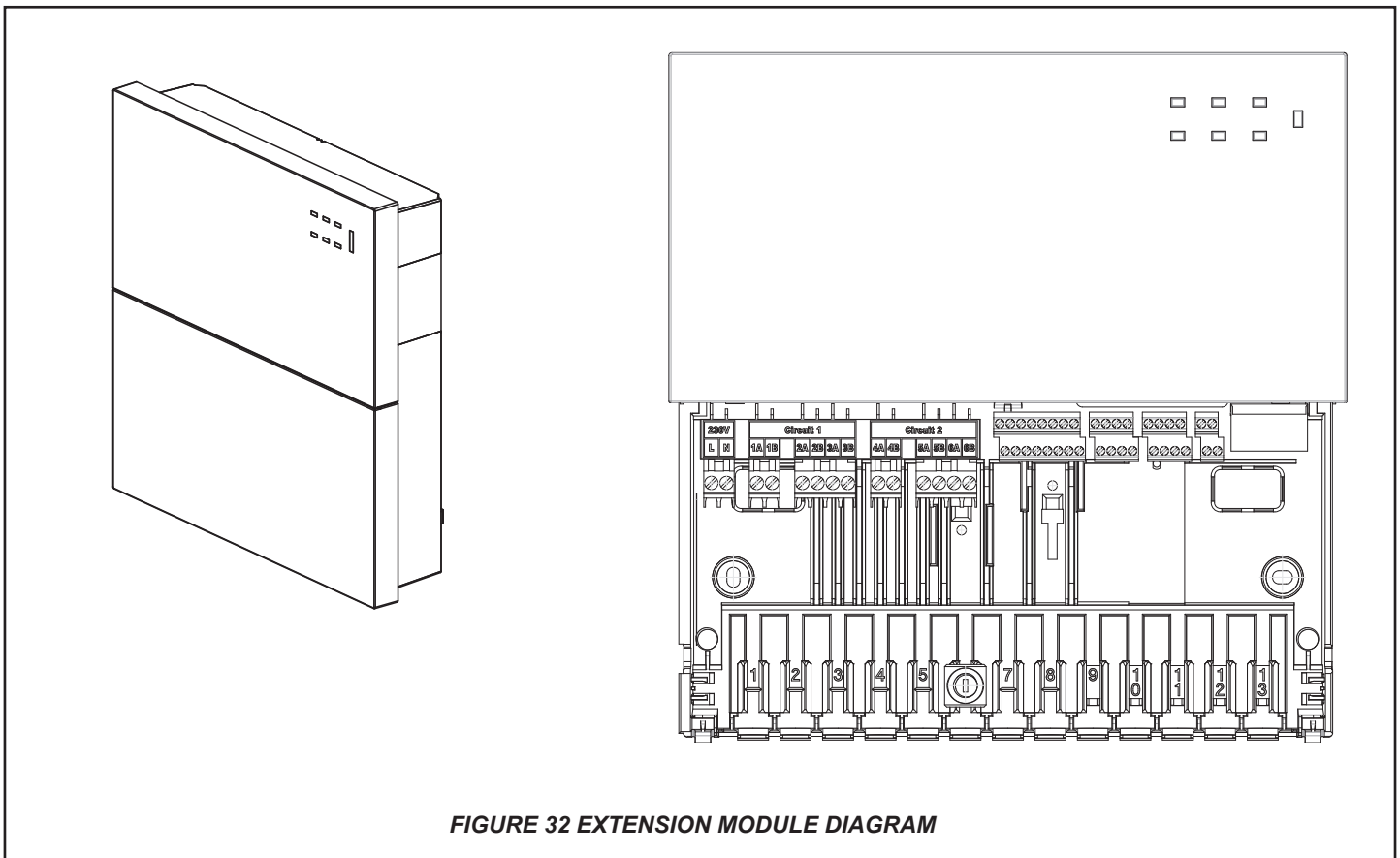


### 3 INSTALLATION

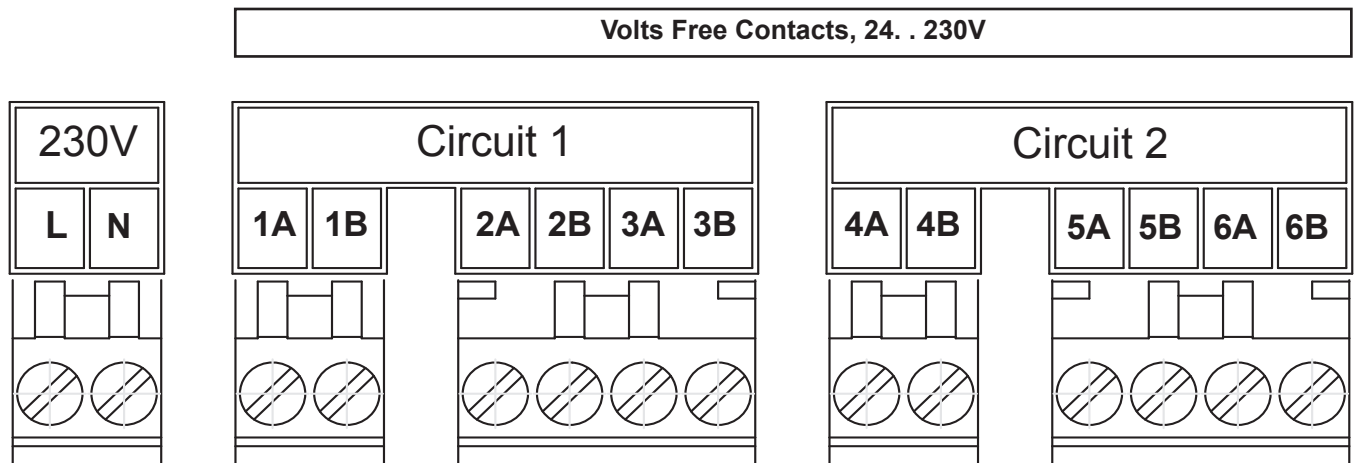
#### 3.1 VariCAN Adapter



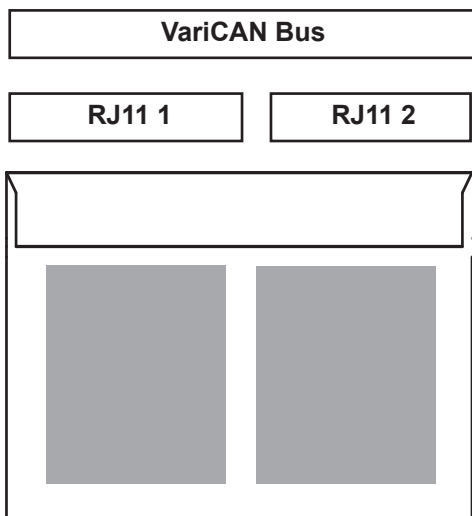
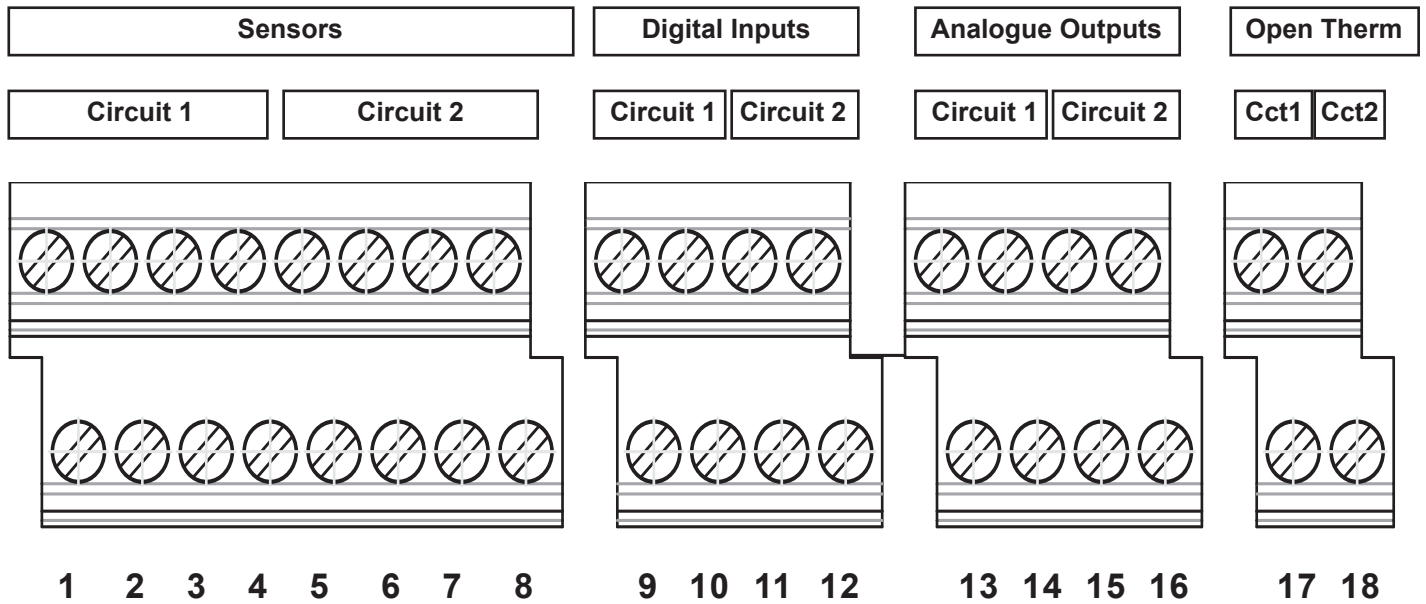
#### 3.2 Extension Module



### 3.3 Electrical Connections



The supply connection only requires 230V 50Hz Live and Neutral as the EM is a double insulated design with no PE requirement or distribution of PE.



### 3.4 Heating Circuit Connections

Constant Temperature							
	HC Pump		Room sensor*	Flow sensor*	Outside sensor*	HC Enable, Override, Holiday, Frost*	OpenTherm*
Circuit 1	On/Off	1a, 1b	1	2	3	9	17
	0-10V	13					
Circuit 2	On/Off	4a, 4b	5	6	7	11	18
	0-10V	15					

Mixing (Variable Temperature)							
	HC Pump		Valve				
			Open	Close			
Circuit 1	On/Off	1a, 1b	2a, 2b	3a, 3b			
	0-10V	13	14				
Circuit 2	On/Off	4a, 4b	5a, 5b	6a, 6b			
	0-10V	15	16				
	Room sensor*		Flow sensor	Outside sensor*	HC Enable, Override, Holiday, Frost*	OpenTherm*	
Circuit 1	1		2	3	9	17	
Circuit 2	5		6	7	11	18	

Air Blower							
	HC Pump		Fan				
	Circuit 1	On/Off	1a, 1b	2a, 2b			
	0-10V	13	14				
Circuit 2	On/Off	4a, 4b	5a, 5b				
	0-10V	15	16				
	Room sensor*		Flow sensor	Outside sensor*	HC Enable, Override, Holiday, Frost*	OpenTherm*	
Circuit 1	1		2	3	9	17	
Circuit 2	5		6	7	11	18	

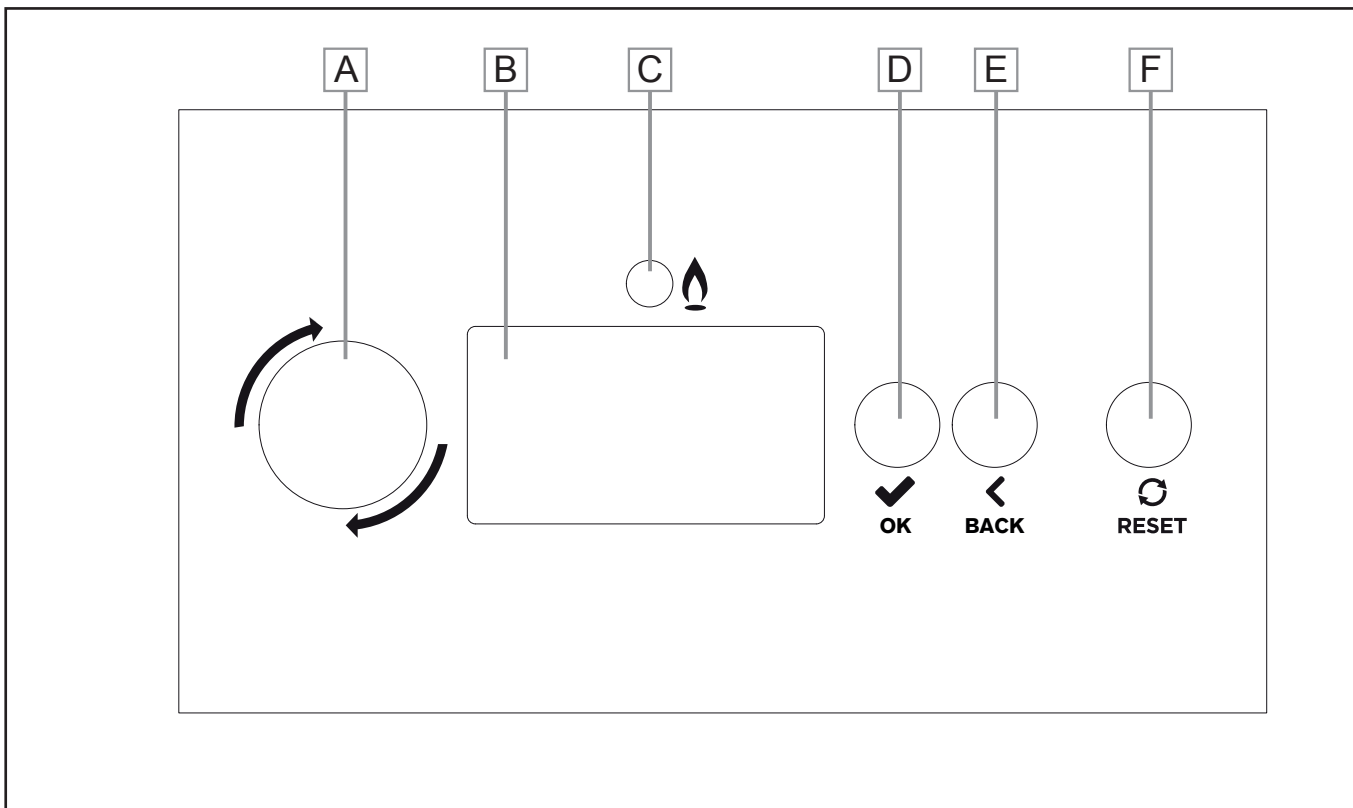
### 3.5 Domestic Hot Water Circuit Connections

DHW Storage Tank							
	Primary Pump		Circulation Pump*	Tank sensor	HC Enable, Override, Holiday, Frost*	OpenTherm*	
Circuit 1	On/Off	1a, 1b	2a, 2b	1	9	17	
	0-10V	13	14				
Circuit 2	On/Off	4a, 4b	5a, 5b	5	11	18	
	0-10V	15	16				

\*Optional

## 4 CONFIGURATION

### 4.1 System Manager Interface



**FIGURE 33 SYSTEM MANAGER INTERFACE**

#### A. Rotary Knob

- Enter a menu, if in the normal operation screen, and highlight the first menu item.
- Scroll up (anti-clockwise) or down (clockwise) in a menu
- Change the value in parameter setting.
- If an error is showing in the title bar, scroll to the associated error screen(s), and return.

#### B. LCD Display Screen

- Menu and status display.

#### C. Burner LED

- Will be on if the burner is lit.

#### D. Select button

- Enter a menu, if in the normal operation screen, and highlight the first menu item.
- Enter the highlighted menu (sub menu or parameter), if in a menu or sub menu.
- If in a parameter setting, select a parameter which will then flash for adjustment, once adjusted using the rotary knob press again to store and move on.

#### E. Back button

- In a menu, return to the previous menu layer.
- In parameter setting, exit the parameter without storing the value.
- In a guided assistant, go back to the previous screen.

#### F. Reset button

- Reset the associated boiler module error, if a resettable (lockout) error is active.
- Return to the normal operation screen.

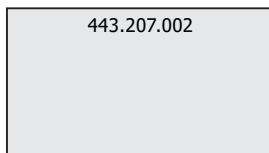
## 4.2 Cascade and/or Extension Modules

Once the VariCAN adapters have been installed and connected into each Boiler and/or Extension Module/s in the cascade then the system can be configured.

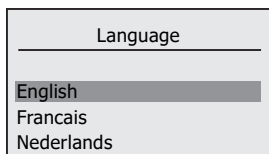
Power up each Boiler and/or Extension Module in the system then return to the Master boiler to start the configuration. The following screens will be displayed on each boiler at power up:

The screens assume two Boilers and one Extension Module, however the configuration is similar for any number of Boilers, up to 16 and Extension Modules, up to 4.

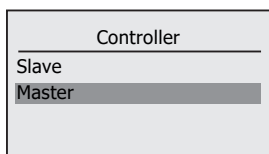
System manager software revision:



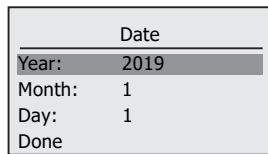
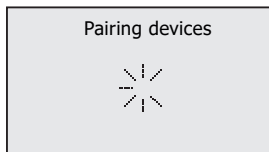
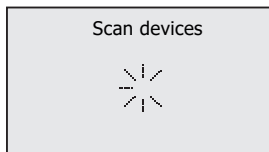
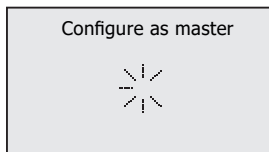
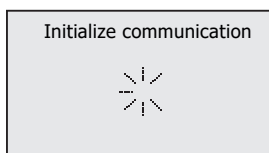
Initial configuration



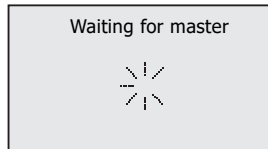
The default language will be selected and highlighted.



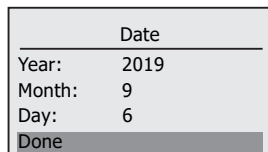
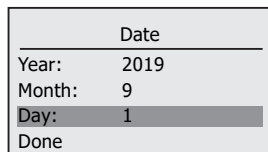
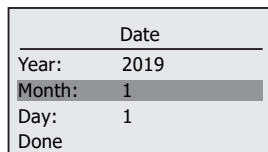
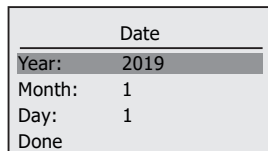
On the Master boiler in the cascade, select "Master", the following screens will appear in the order shown below:



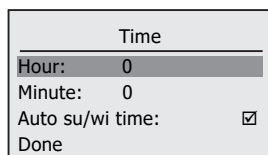
Once the master boiler System Manager has been selected and the Scan Devices completed, all Slave boilers will display the following screen.



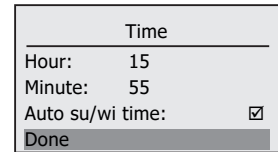
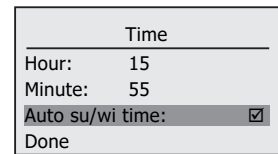
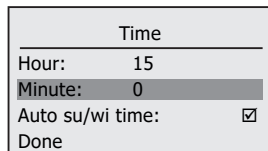
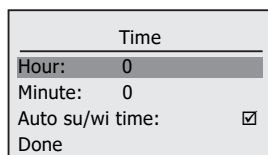
The Extension Module/s will show alternating illuminated Green LEDs. On the Master boiler, set the date fields, followed by "Done".



Once the date is set and "Done" is selected the following screen is displayed:

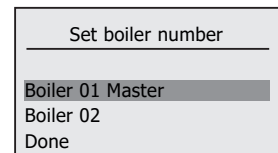


On the Master boiler now set the time and settings for Summer/Winter time change, followed by "Done":



Once the Master boiler has the date and time set then all slave boilers will adopt these settings.

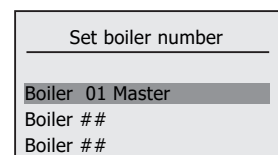
Once 'Done' is selected, the following screen will appear:



This is an example where there are two boilers in the Cascade, each Slave boiler will be listed from Boiler 02 onwards, Boiler 01 is always the Master, and the configuration of Slave boilers will be different to the Master but will follow the identical procedure.

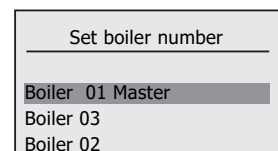
There is also one Extension Module which is detected and listed separately to the Boilers.

The Boiler numbers in the case of only 2 boilers can appear in any order, this is in relation to how they are discovered during the Bus Scanning process, and in this example the Slave boiler is also pre-allocated as boiler 2. When a Boiler is highlighted in the menu, the corresponding TTL-i5 VariCAN adapter LED will illuminate, in the case of a Slave boiler the System Manager Display will also change to inverse video to allow identification, selection and labelling. For any Slave boilers where there is more than 2 boilers in the cascade, the display will show:



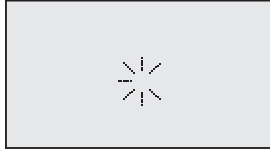
If any Slave boilers are not listed, check that they are connected correctly to the bus and that they have their power switched on.

Each Slave boiler can be selected and a number allocated, usually corresponding to their physical location in the cascade:

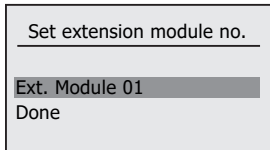


In the case above, the second Slave boiler highlighted was identified as Boiler 03 in the cascade, and the third Slave as Boiler 02, adjacent to the Master boiler.

Once you are happy with the selection of the Slave boiler numbers, select 'Done'. The following screen will then appear:



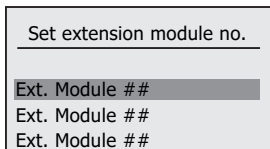
The Master boiler is now scanning the installation to locate any Extension Modules.



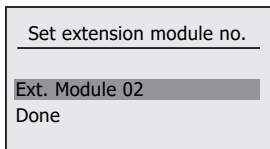
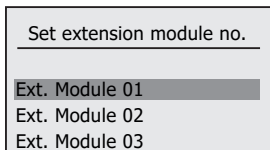
In this example there was only one Extension module, therefore it was automatically allocated as 01.

If any Extension modules are not listed, check that they are connected correctly to the bus and that they have their power switched on.

If there is more than one Extension module the display will show them as all unallocated. When an Extension module is highlighted in the menu, the corresponding Extension module LEDs will flash:



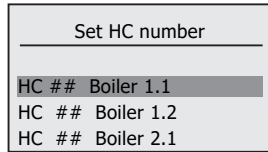
Each Extension module can be selected and a number allocated, usually corresponding to their physical location in the installation:



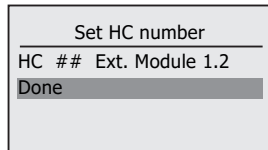
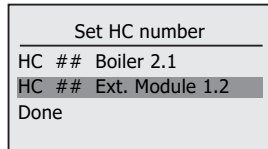
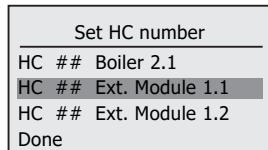
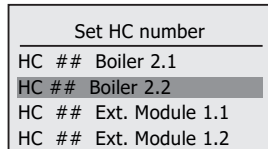
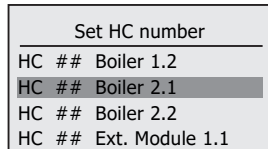
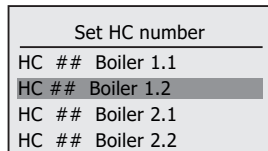
Once the Extension module numbers have been set, select 'Done' to continue.

The Master boiler is now scanning the installation to locate all of the connected Heating Circuits.

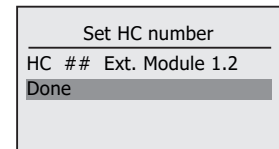
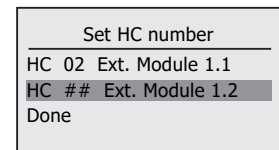
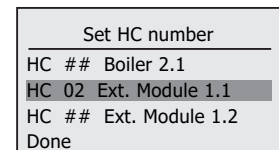
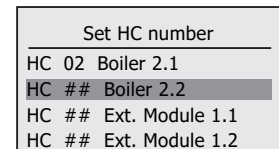
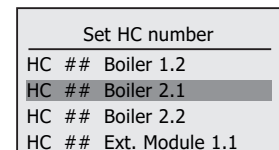
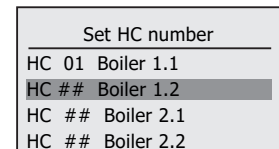
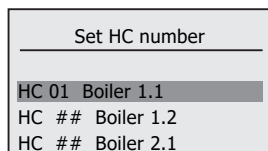
Upon completion the following screen will be displayed showing all available Heating Circuits in relation to all boilers and Extension modules:



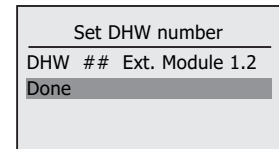
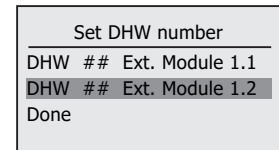
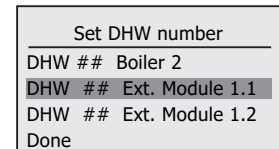
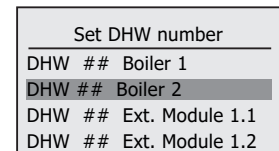
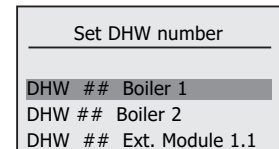
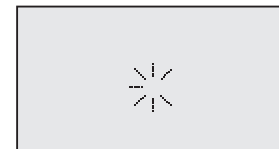
In this example each boiler has 2 heating circuits that may be selected for use. By scrolling down all boiler Heating Circuits can be selected and allocated a unique number in the system. For example in a two boiler cascade:



Once you have selected and allocated a number to the Heating Circuits that you wish to use and configure, for example a single HC on the Master boiler, no HCs on the Slave boiler and a single HC on the Extension module:



Select 'Done' and the following screens will appear:



**Note:** The DHW circuit shares resources with the second Heating Circuit on each boiler, therefore if a second HC is present and it is already allocated then a DHW circuit will not be available for selection. The extension module also has two circuits that may be allocated, however it can support two DHW circuits rather than one. It can also support a single HWS.

Once you have selected and allocated a number to the DHW Circuits that you wish to use and configure, for example, in line with the above example, a single DHW circuit on the Master boiler, no DHW circuits on the Slave boiler with a single DHW circuit on the Extension module:

Set DHW number

---

DHW 01 Boiler 1  
 DHW ## Boiler 2  
 DHW ## Ext. Module 1.2

Set DHW number

---

DHW 01 Boiler 1  
 DHW ## Boiler 2  
 DHW ## Ext. Module 1.2  
 Done

Set DHW number

---

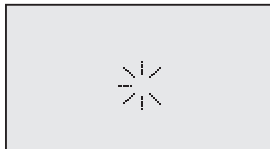
DHW ## Boiler 2  
 DHW 02 Ext. Module 1.2  
 Done

Set DHW number

---

DHW ## Ext. Module 1.2  
 Done

Select 'Done' and the following screen will appear:



### 4.3 Backup/Recovery

Load Backup?

---

No  
 Yes

If you have replaced the System Manager you can recover the full configuration of the system provided that you had allocated a slave boiler and made a backup previously, otherwise select 'No'.

### 4.4 Plant Configuration

Configure plant?

---

No  
 Yes

Plant configuration is related to the shared resources necessary for the operation of the complete cascade/plant. To configure these select 'Yes' and then follow the screens. If you are in a cascade and have hydraulic separation then select the type of separation that is present.

Hydraulic separation?

---

No  
 Header  
 Plate heat exchanger

If you have a header thermistor select 'Yes' if not then the average flow temperature of the active boilers will be used to calculate the average flow temperature which will then be used for the cascade.

Header thermistor?

---

No  
 Yes

If you are using a Cascade flue system that requires an increase in the minimum fan speed then select 'Multiline'

Set flue system

---

Standard  
 Multiline

If the boiler cascade has a common pump that circulates water through all the boilers in the Cascade the select the output of the Master boiler that controls this pump. Otherwise select 'None'.

Loc'n of shared boiler pump

---

None  
 PWM/0-10V ()  
 MFR1 ()

The following outputs can be configured for this function:

Loc'n of shared boiler pump

---

None  
 PWM/0-10V ()  
 MFR1 ()  
 MFR2 ()

Loc'n of shared boiler pump

---

PWM/0-10V ()  
 MFR1 ()  
 MFR2 ()  
 MFR3 ()

Loc'n of shared boiler pump

---

MFR1 ()  
 MFR2 ()  
 MFR3 ()  
 MFR4 ()

Loc'n of shared boiler pump

---

MFR2 ()  
 MFR3 ()  
 MFR4 ()

Loc'n of shared boiler pump

---

MFR3 ()  
 MFR4 ()

**Note:** Once a programmable has been selected the function will appear within the parenthesis at the right of the designated output name.

If the boiler cascade has a common pump that circulates water through either the boiler cascade or cascade header and supplies the heating load then select the output of the Master boiler that controls this pump. Otherwise select 'None'.

Select Loc'n of system pump

---

None  
 PWM/0-10V ()  
 MFR1 ()

The following outputs can be configured for this function:

Select Loc'n of system pump

---

None  
 PWM/0-10V ()  
 MFR1 ()  
 MFR2 ()

Select Loc'n of system pump

---

PWM/0-10V ()  
 MFR1 ()  
 MFR2 ()  
 MFR3 ()

Select Loc'n of system pump

---

MFR1 ()  
 MFR2 ()  
 MFR3 ()  
 MFR4 ()

Select Loc'n of system pump

---

MFR2 ()  
 MFR3 ()  
 MFR4 ()

Select Loc'n of system pump

---

MFR3 ()  
 MFR4 ()

If the boiler cascade has a shunt pump to control the temperature differential of the cascade flow to return then select the output of the Master boiler that controls this pump. Otherwise select 'None'.

Select Loc'n of shunt pump?

None

PWM/0-10V ( )

MFR1 ( )

The following outputs can be configured for this function:

Select Loc'n of shunt pump

None

PWM/0-10V ( )

MFR1 ( )

MFR2 ( )

Select Loc'n of shunt pump

PWM/0-10V ( )

MFR1 ( )

MFR2 ( )

MFR3 ( )

Select Loc'n of shunt pump

MFR1 ( )

MFR2 ( )

MFR3 ( )

MFR4 ( )

Select Loc'n of shunt pump

MFR2 ( )

MFR3 ( )

MFR4 ( )

Select Loc'n of shunt pump

MFR3 ( )

MFR4 ( )

The Master boiler in a cascade can indicate if a system fault condition exists, so any boiler fault, Master or Slave. This can then be used to indicate to plant monitoring equipment if any fault exists in the complete system. If this is required then select the output of the Master boiler that controls this signal. Otherwise select 'None'.

System fault indication

None

PWM/0-10V ( )

MFR1 (HC1 pump)

The following outputs can be configured for this function:

System fault indication

None

PWM/0-10V ( )

MFR1 (HC1 pump)

MFR2 (DHW pump)

System fault indication

PWM/0-10V ( )

MFR1 (HC1 pump)

MFR2 (DHW pump)

MFR3 (Boiler on indicator)

System fault indication

MFR1 (HC1 pump)

MFR2 (DHW pump)

MFR3 (Boiler on indicator)

MFR4 (Boiler Fault Indicator)

System fault indication

MFR2 (DHW pump)

MFR3 (Boiler on indicator)

MFR4 (Boiler Fault Indicator)

System fault indication

MFR3 (Boiler on indicator)

MFR4 (Boiler Fault Indicator)

The plant may be controlled in a number of ways:

1. 0-10V analogue input
2. 230V 50Hz switched live input via a 'Volts Free' contact
3. OpenTherm Master controller
4. OpenTherm On/Off input via a SELV 'Volts Free' contact

### 0-10V analogue input control

If the Plant cascade control is via a BMS with a 0-10V signal then this can be selected and configured next. The following options are available:

Configure 0-10V input

None

0-10V Capacity

0-10V Temperature

Configure 0-10V input

None

0-10V Capacity

0-10V Temperature

Configure 0-10V input

0-10V Capacity

0-10V Temperature

Once 0-10V control is selected a number of parameters must be defined. The default settings are as shown below but these can be changed if required. To configure the parameters select 'Yes', to accept the current default settings select 'No'.

Configure 0-10V parameters?

No

Yes

Configure 0-10V parameter?

No

Yes

Voltage demand. This setting determines the switching point at which demand is expected by the system, anything below this is at keep alive voltage:

Configure voltage demand

1.0V

Done

Configure voltage demand

1.0V

Done

Voltage life zero. This setting determines the minimum keep alive voltage where the system expects a voltage to be present on an operational interface, anything below this indicates a wiring fault:

Configure voltage life zero

0.0V

Done

Configure voltage life zero

0.0V

Done

### SL1 230V Demand

Configure SL1

None

Enable

If this signal is to be configured then select Enable, otherwise select 'None'. This will then prompt for a Cascade flow temperature set point, which will be the target temperature for the cascade under direct SL1 control.

Plant Setp. SL1

85°C

Done

Once this level is set, 'Done' may be selected.



NOTE: The next section can only be selected in software revisions from 443.207.000 and above.

**Plant – SL2 230V External heat source availability and control configuration**

The Master boiler can control an External heat source to provide heat into the cascade. In order to do this, it requires an input signal to inform it as to when the External heat source is available. SL2 is used as the input to tell the Master that the External heat source is available to supply heat into the cascade.

Once this is determined, the control signal for the External heat source must be defined. It is possible to select the 0-10V output or one of the MFR Multi-Function Relays, 1 to 4.

Configure SL2

None  
Ext. heat source release

Configure SL2

None  
Ext. heat source release

Once Ext. heat source release is selected the required control signal can be selected and configured.

Ext. heat source control

None  
PWM/0-10V ()  
MFR1 ()

Ext. heat source control

None  
PWM/0-10V ()  
MFR1 ()  
MFR2 ()

Ext. heat source control

PWM/0-10V ()  
MFR1 ()  
MFR2 ()  
MFR3 ()

Ext. heat source control

MFR1 ()  
MFR2 ()  
MFR3 ()  
MFR4 ()

Ext. heat source control

MFR2 ()  
MFR3 ()  
MFR4 ()

Ext. heat source control

MFR3 ()  
MFR4 ()

**0-10V Ext. heat source control settings.**

If the 0-10V output is selected to control the demand to the External heat source, then the following parameters must be set. The voltage threshold to turn on the External heat source.

Configure voltage demand

0.0V  
Done

Configure voltage demand

1.5V  
Done

Configure voltage off

0.0V  
Done

Configure voltage off

1.0V  
Done

**External heat source capacity**

In order to be able to determine the capacity of the cascade the Master boiler needs to know what the maximum capacity rating of the External heat source is.

Maximum rating

35.0kW  
Done

Maximum rating

80.0kW  
Done

The demand switch on capacity for the external heat source can then be set.

Switch on capacity

60%  
Done

Switch on capacity

40%  
Done

The next plant control signal that may be configured is the OpenTherm Bus signal which is a bidirectional signal to the cascade.

**OpenTherm**

This bus signal can both control and monitor the status of the cascade via the Master boiler. It has a number of modes of operation:

1. On/Off demand
2. Temperature setpoint demand
3. Capacity setpoint demand

If no OpenTherm control of the cascade is required then 'None' may be selected.

Configure OpenTherm

None  
On demand  
Temperature demand

The options that may be selected are as below, if 'On demand' is selected this is effectively a PELV 'volts free' enable signal.

Configure OpenTherm

None  
On demand  
Temperature demand  
Capacity demand

If 'On demand' is configured then this will then prompt for a Cascade flow temperature set point, which will be the target temperature for the cascade under direct OpenTherm control.

OpenTherm Temp. Setpoint

60°C  
Done

Once this level is set, 'Done' may be selected.

For temperature demand the maximum flow temperature set point can be set.

Configure OpenTherm

On demand  
Temperature demand  
Capacity demand

**OpenTherm Max. Flow Temperature:**

Set max flow temp

80°C

Done

Set max flow temp

80°C

Done

Configure OpenTherm

Temperature demand

Capacity demand

The next plant function that may be selected is the outside sensor input if one is to be used for the control of the flow temperature from the cascade. If not then select 'Done'.

Outside sensor available?

None

Yes

This is now the end of plant configuration.

**4.5 Boiler Configuration**

The next stage is to configure each of the boilers in the cascade. This process is carried out from the Master boiler. The configuration parameters for the boiler configuration are specific to that particular boiler.

Select the boiler from the list which is to be configured.

Select boiler to configure

Boiler 1

Boiler 2

Done

If the selected boiler has its own unique primary water circulation pump this is where it is configured. Once again one of the programmable outputs from the boiler can be used to control this pump function. If no individual boiler pump is present then select 'None'.

Select location of boiler pump

None

PWM/0-10V ()

MFR1 ()

Select location of boiler pump

None

PWM/0-10V ()

MFR1 ()

MFR2 ()

Select location of boiler pump

PWM/0-10V ()

MFR1 ()

MFR2 ()

MFR3 ()

Select location of boiler pump

MFR1 ()

MFR2 ()

MFR3 ()

MFR4 ()

Select location of boiler pump

MFR2 ()

MFR3 ()

MFR4 ()

Select location of boiler pump

MFR3 ()

MFR4 ()

The next boiler configuration step is the Boiler On indication output. Once again any of the programmable outputs may be selected. Usually MFR3 is allocated. The full screens list is omitted for simplicity.

Boiler on indication

None

PWM/0-10V ()

MFR1 ()

The next boiler configuration step is the Boiler Fault indication output. Once again any of the programmable outputs may be selected. Usually MFR4 is allocated. The full screens list is omitted for simplicity.

Boiler fault indication

None

PWM/0-10V ()

MFR1 ()

The next boiler configuration step is the LPG valve control output. This function is for control of an external LPG valve in series with the Gas line as an additional safety feature. It is opened during the burner phase of the Boiler. Once again any of the programmable outputs may be selected. The full screens list is omitted for simplicity.

LPG valve

None

PWM/0-10V ()

MFR1 (HC1 pump)

The next boiler configuration step is the powered flue damper control output. This function is for control of an external flue damper as an additional safety feature. It is opened during the fan start-up and closed after the fan post purge period of the Boiler. Once again any of the programmable outputs may be selected. The full screens list is omitted for simplicity.

Flue damper

None

PWM/0-10V ()

MFR1 (HC1 pump)

Once completed the following screen will be displayed:

Select boiler to configure

Boiler1 ✓

Boiler2

Done

Note: The boiler that has just been configured will now have a 'tick' next to its designation.

The next boiler to configure can now be selected. The process above is then repeated for all boilers in the cascade. After all Boilers have been configured, select 'Done'.

## 4.6 Heating Circuit Configuration

If heating circuits were located and allocated during initial setup then they will now appear here to be configured. There is a maximum number of heating circuits for each boiler, in this case two circuits identified by boiler number and HC number. E.g. Boiler 1.1 is boiler 1 HC 1. The following screens are based upon the example configuration as selected above.

Select HC to configure
HC1 Boiler 1.1
HC2 Ext. Module 1.1
Done

At the end of the list of allocated HCs 'Done' is displayed.

Firstly select the HC you wish to configure, in this instance we are configuring the HC2 on the Extension module:

Select HC to configure
HC1 Boiler 1.1
HC2 Ext. Module 1.1
Done

Next select the type of heating circuit that is required:

Configure heating circuit
Constant temperature
Mixing circuit

The next step is to configure the HC pump control signal if it has its own unique circulation pump. If you have already configured a System pump this may not be required so 'None' may be selected. One of the programmable outputs can be selected for this function. The following screen will be displayed.

HC pump control
None
On/Off
0-10V

If the heating circuit selected is a Mixing circuit then an additional signal must be configured for the mixing valve:

Valve
None
On/Off
0-10V

The mixing valve run time, end to end, can be set as required:

Mixing valve run time
120seconds
Done

Select the time and adjust to the desired setting, confirm and then select 'Done'.

Set max flow temp
120seconds
Done

Once completed the next step is to set the Maximum and Minimum flow temperature for the HC.

Set max flow temp
85°C
Done

Select the temperature and adjust to the desired setting, confirm and then select 'Done'.

Set max flow temp
75°C
Done

Set min flow temp
15°C
Done

Set min flow temp
30°C
Done

If the HC is providing control for an Air heater then the Air heater fan control signal needs to be selected:

Air Heater
None
On/Off
0-10V

If an Air heater fan control signal is selected, then the control parameters for this function are then set. The start flow temperature is the flow temperature into the Air heater at which the fan is switched on, this allows the Air heater matrix to be pre-heated prior to operation.

Start flow temp
35°C
Done

Select the temperature and adjust to the desired setting, confirm and then select 'Done'.

Start flow temp
35°C
Done

The minimum Air heater fan overrun time can be set as required:

Min delay on off time
5minutes
Done

Select the time and adjust to the desired setting, confirm and then select 'Done'.

Min delay on off time
8minutes
Done

Once completed the next step is to confirm if a Room Temperature sensor is connected and being used control the room temperature for this HC.

Room Sensor available?
No
Yes

The next step is to confirm if an Outside Temperature sensor is connected and being used as an input to the HC to calculate the required flow temperature.

Outside Sensor available?
No
System
Local

If the Master boiler outside sensor is equipped and required for use then select "System". If the outside sensor is specific to this heating circuit and wired to the heating circuit outside sensor input then select "Local". Depending upon the two choices, Room and Outside sensor, above the next screen will show what options are available for control of the flow temperature for that specific Heating Circuit.

Control variant

Flow

Weather

Room

Control variant

Flow

Weather

Room

Weather and Room

The next step is to select the function for the SL1 230V switched live input in relation to this HC, if it is required.

It can be used as a HC enable signal, an Override signal, a Holiday signal or a Frost protection input from an external 'Volts Free' contact for that specific HC. If this input is already configured, you will be queried, or if not required then 'None' can be selected.

Configure digital input 1

None

Enable

Override

Configure digital input 1

None

Enable

Override

Holiday

Configure digital input 1

Enable

Override

Holiday

Frost

Configure digital input 1

Override

Holiday

Frost

Configure digital input 1

Holiday

Frost

If the first digital input is configured as either Override or Holiday, then the second digital input may be configured as Enable. This allows the forced requests to take priority.

Configure digital input 2

None

Enable

The next step is to configure the OpenTherm input if it is to be used for this specific HC. The OpenTherm interface can be operated in a number of modes, On/Off as a 'volts free' PELV signal, Temperature control from an OpenTherm master, or if already configured you will be prompted, or if not used select 'None'.

Configure OpenTherm

None

On/Off

Temperature control

Configure OpenTherm

None

On/Off

Temperature control

Configure OpenTherm

On/Off

Temperature control

If On/Off or Temperature control is selected then the system needs to know of the OpenTherm Master has a built in timeclock.

OT Master with time clock?

No

Yes

The next step is to configure the pump protection function for this specific heating circuit.

Configure pump protection?

No

Yes

If Pump protection is selected then an associated period can be set, the time duration between protection cycles and the time point at which the function should start to operate the pump.

Pump protection interval

1day(s)

Done

Pump protection time point

12:00

Done

The next step is to select if any DHW circuit demand configured in the system has priority over this specific heating circuit. If 'Yes' is selected than any DHW circuit demand will interrupt the HC function.

DHW priority?

No

Yes

The next step is to set the initial mode of operation for this HC. By selecting the highlighted field the choices are shown in the following screens. Once selected then select 'Done'.

Operating mode

Standby

Done

Operating mode

Time clock single day

Done

Operating mode

Time clock multiple days

Done

Operating mode

Day

Done

Operating mode

Night

Done

Operating mode

Day

Done

Once completed the following screen will be displayed:

Select HC to configure

HC1 Boiler 1.1 ✓

HC2 Ext. Module 1.1 ✓

Done

**Note:** The HC that has just been configured will now have a '✓' next to its designation.

After all HCs have been configured, select 'Done'.

## 4.7 Domestic Hot Water Circuit Configuration

If DHW circuits were located and allocated during initial setup then they will now appear here to be configured. There is a maximum number of local DHW circuits for each boiler, in this case one circuit identified by boiler number and HC number. E.g. Boiler 1 is boiler 1 DHW circuit.

Firstly select the DHW circuit you wish to configure, in this instance we are configuring the DHW2 on the Extension module:

If the selected DHW circuit has its own unique primary DHW charge pump this is where it is configured. Once again one of the DHW signal output from the Extension module can be used to control this pump function. If no individual charge pump is present then select 'None'.

If the DHW circuit uses a Circulation or de-stratification pump then this can be configured:

The DHW circuit on an Extension module may have a single or two tank temperature sensors, typically one is used in the middle pocket of the tank, but two can be configured with the additional one placed in a pocket at the bottom of the tank.

Once completed the next step is to set the Maximum tank temperature for the DHW circuit, followed by 'Done'.

The next step is to select the function for the SELV Digital Input signal in relation to this DHW circuit, if it is required. It can be used as a DHW circuit enable signal or an Override signal input from an external 'Volts Free' contact for that specific DHW circuit. If this input is already configured, you will be queried, or if not required then 'None' can be selected.

If the first digital input is configured as Override, then the second digital input may be configured as Enable. This allows the Override to take priority.

The next step is to select if the OpenTherm interface is capable of controlling the DHW setpoint and time. If this is not used select 'None'.

The next step is to set the Antilegionella operating parameters. The options allow for setting a fixed day and time, or a fixed interval between cycles. Both have the ability to set the Tank temperature that the tank must achieve during the cycle. If the function is not required, 'None' may be selected.

On selecting weekday the following screens with options are shown, the weekday and Start time can be set:

Once set select 'Done' to continue:

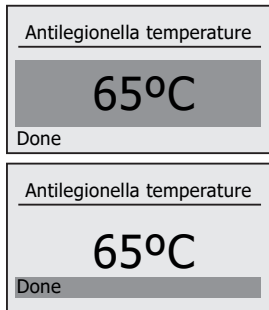
Next you will be prompted to set the Tank temperature for the Antilegionella cycle:

Once the required temperature has been set select 'Done' to confirm and continue:

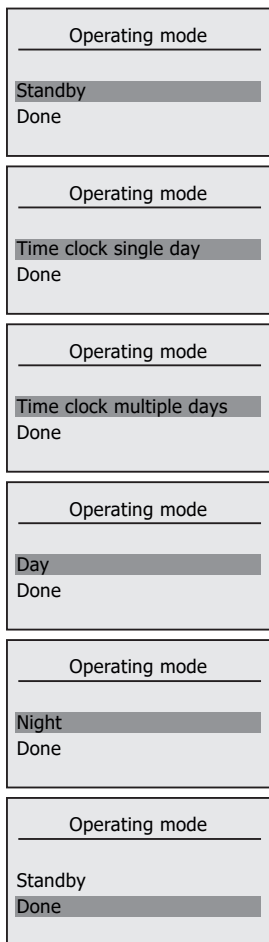
If Interval is selected then the following screen will be shown and the interval between Antilegionella cycles can be set:

Once the interval is set select 'Done'.

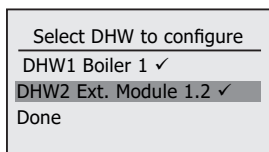
Once again the Antilegionella Tank temperature can be set followed by 'Done'.



The next step is to set the initial mode of operation for this DHW circuit. By selecting the highlighted field the choices are shown in the following screens. Once selected then select 'Done'.

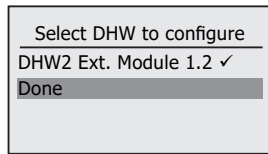


Once completed the following screen will be displayed:



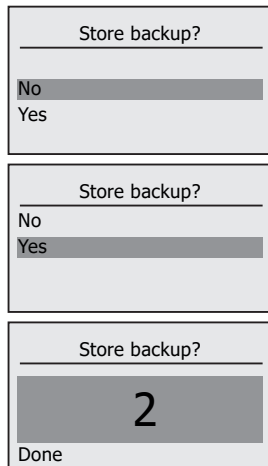
**Note:** The DHW circuit that has just been configured will now have a '✓' next to its designation.

The next allocated DHW circuit to configure can now be selected. The process above is then repeated for all DHW circuits in the cascade.



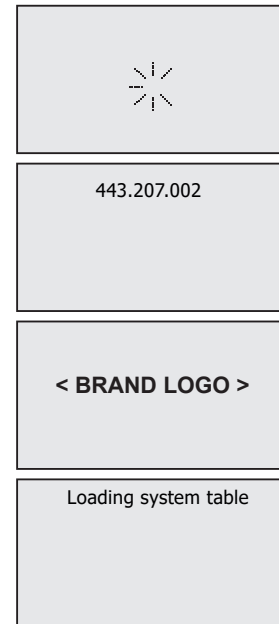
After all DHWs have been configured, select 'Done'.

If a slave boiler is present the Master data can be stored on this system manager for safe keeping.

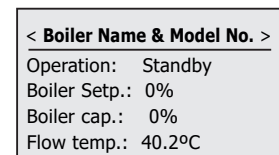


The system configuration has now been completed. The settings relating to the Plant, Heating circuits and DHW circuits can be changed in the corresponding settings menu within each of the sections of the menu system. Refer to the operating guide section of this manual.

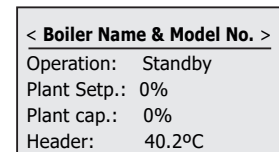
The system will now reboot and the following screens will be displayed:



Then the following status screen will be shown, this screen shows the boiler status for a Master boiler in a cascade, a second status screen exists and can be accessed by rotating the knob anticlockwise:




This then shows that status of the Plant.



No configuration is specifically required for the Cascade Manager. Refer to the Operating Guide for the status and settings within this function.

## 5 TECHNICAL SPECIFICATIONS

<b>General</b>	
Dimensions	224mm x 232mm x 55mm
Weight	0.9kg
Nominal supply voltage	230V 50Hz
Power consumption	10 Watts
Supply fuse rating	1A
Safety class	Protection class II
EMC suppression	Category 3 (surge immunity)
Maximum Ambient temperature. (Storage)	-25oC to 60oC
Maximum Ambient temperature. (Operation)	0-50oC
Maximum Relative humidity	<=95%
Pollution degree	2
Software safety class	A
ELV limits	On the PCB < 36V idle, on the connectors < 25V
Relay load switching cycles	< 3/Min
Protection	IP21
<b>Relay Outputs</b>	
Number	6
Type	Volts free normally open
Make-Break capacity	Max. 250 VAC, Max 3A
Terminal connection	0.5 – 2.5 mm <sup>2</sup>
<b>Analog inputs</b>	
Number	8
Type	Type 1
Application	NTC sensor, 10K B3977
Terminal connection	0.14 – 1.5 mm <sup>2</sup>
<b>Analog outputs</b>	
Number	4
Type	SELV
Application	0-10V control
Terminal connection	0.14 – 1.5 mm <sup>2</sup>
<b>Digital inputs</b>	
Number	4
Type	SELV
Application	Volts free switch contact
Terminal connection	0.14 – 1.5 mm <sup>2</sup>
<b>OpenTherm® Slave</b>	
Number	2
Application	Communication with OpenTherm room control
Terminal connection	0.14 – 1.5 mm <sup>2</sup>
<b>Communication</b>	
Number	2
Application	VariCAN multi-drop Bus
Terminal connection	RJ11 6P4



**WEEE DIRECTIVE 2012/19/EU**  
**Waste Electrical and Electronic Equipment Directive**

- At the end of the product life, dispose of the packaging and product in a corresponding recycle centre.
- Do not dispose of the unit with the usual domestic refuse.
- Do not burn the product.
- Remove the batteries.
- Dispose of the batteries according to the local statutory requirements and not with the usual domestic refuse.



FM 59915  
Manufactured under  
an ISO 9001  
registered quality  
management system

At Ideal Heating we take our environmental impact seriously, therefore when installing any Ideal Heating product please make sure to dispose of any previous appliance in an environmentally conscious manner. Households can contact their local authority to find out how. See <https://www.gov.uk/managing-your-waste-an-overview> for guidance on how to efficiently recycle your business waste.

### Technical Training

Our Expert Academy offer a range of training options designed and delivered by our experts in heating. For details please contact:  
[expert-academy.co.uk](http://expert-academy.co.uk)

Ideal Boilers Ltd., pursues a policy of continuing improvement in the design and performance of its products. The right is therefore reserved to vary specification without notice.

Ideal is a trademark of Ideal Boilers.

Registered Office

Ideal Boilers Ltd., National Avenue, Hull, East Yorkshire, HU5 4JB

Tel 01482 492251 Fax 01482 448858

Registration No. London 322 137

EU Authorised Representative:

Atlantic SFDT

44 Boulevard des Etats-Unis, 85 000 La Roche-Sur-Yon, France

+33 (0)2 51 44 34 34

Ideal Commercial Technical Helpline: 01482 498376

Ideal Parts: 01482 498665

[idealheating.com](http://idealheating.com)

**ideal**  
HEATING