

Note 1: Plate Heat Exchanger and gas connections can be located either on the LHS or RHS of the assembly to suit the needs of each particular system.

Note 2: Optional 900kW Plate Heat Exchanger Kit DN150 (UIN226428) one req'd per cascade.

Note 3: Installers, where necessary, should increase from the system connections on the PHEX kit to a pipe size appropriate for the system flow rate.

IMPORTANT - ALL DIMENSIONS ARE IN mm
Drawing provided for reference and information only. Dimensions may be subject to change without notice.

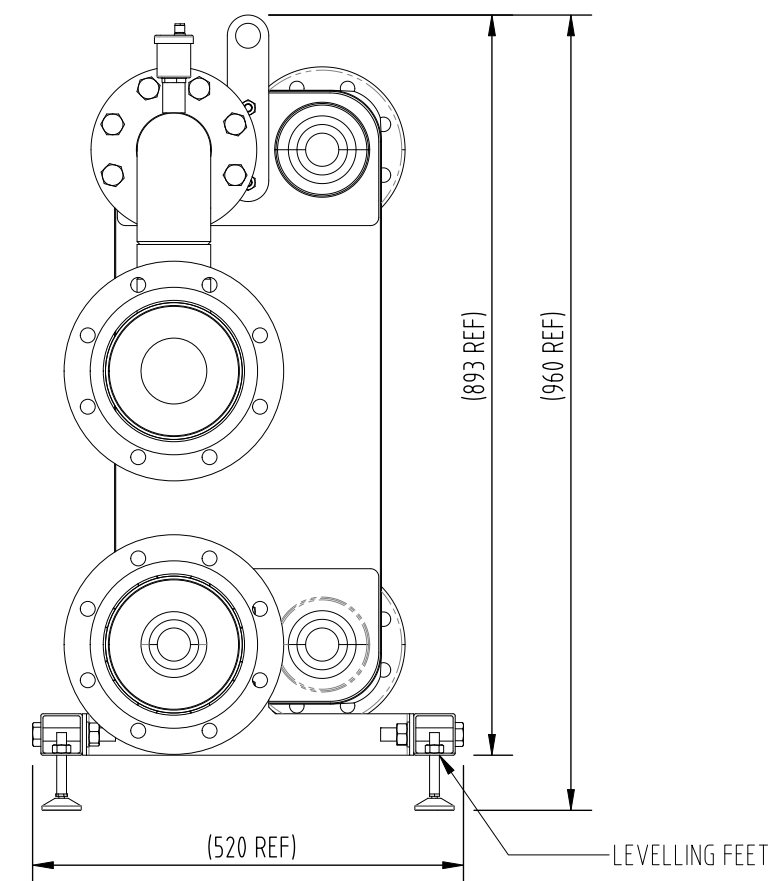
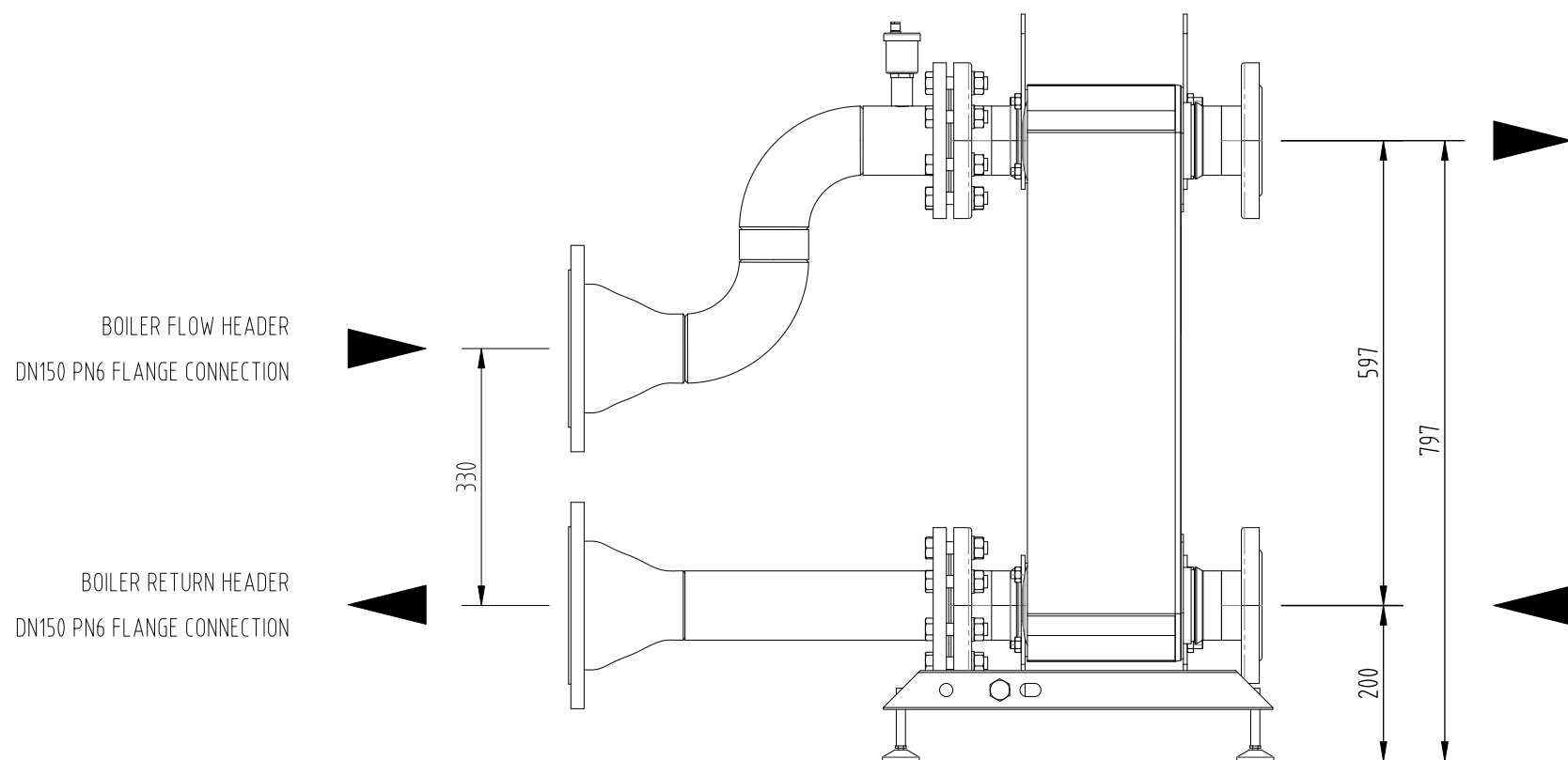

Ideal Commercial reserves the right to amend details or specification without notice. If in doubt please contact an authorised representative