



Chillers and Inverter Air/Water heat pumps with axial fans

# Controller Manual

## Models

Hi-T2



This manual has been created for informative purpose. The company declines any responsibility for the results of any projecting or any installation based on the explanations and/or on the technical specifications provided in this manual. It is besides forbidden the reproduction under any form of the texts and of the figures contained in this manual. This manual is a translation from the official Italian language version. For reasons of environmental respect the Company will not provide the hard copy in the original language which could be directly requested or downloaded from the Company website at any time. In case of any dispute, the original language manual will be the trusted one. Even partial reproduction PROHIBITED © Copyright- Advantix SpA



08	06-2021	M.S.	A.B.	Deleted Chapters 3.3.4 and 5
07	01-2021	M.S.	A.B.	Special functions chapter updated
06	09-2020	M.S.	A.B.	Dynamic setpoint chapter update, Hi-T configuration parameters and fan coil
05	02-2020	M.S.	A.B.	Fan use mode parameter update
04	05-2019	M.S./D.M.	A.B.	Updates and fixes
03	02-2019	M.S.	A.B.	Alignment to V323R103S16
02	12-2018	M.S.	A.B.	Aligned to V323R103S12
01	09-2018	M.S.	A.B.	Aligned to V323R103S12, terminal block update
00	07-2018	D.M.	A.B.	Aligned to V323R103S08
Rev	Date	Issued	Approved	Update description

Catalogue	Series
<b>MUI01137I0100-08</b>	<b>REMOTE CONTROL FOR CHILLERS AND HYDRONIC TERMINALS</b>



Any waste electrical and electronic products must not be disposed of with normal household waste, but disposed of in accordance with the WEEE law based on the European directives 2002/96 / EC and subsequent amendments 2003/108 / EC, inquiring at the Municipality of residence or at the retailer if the product is replaced with a similar one. NOTES: What is reported and described in this manual may not fully coincide with the device in question ("Hi-T2: LCD touch-screen centralized control for hydronic terminals combined with i-HWAK V4, i-SHWAK V4, i-32 V5 chillers , i-HP / i-HP LT, i-MAX, HWA1 "). The Company reserves the right to make changes and updates with respect to what is indicated in this manual.

# CONTENTS

<b>1</b>	<b>GENERAL NOTES.....</b>	<b>5</b>
1.1	PERMITTED USE.....	5
1.2	PROHIBITED USE.....	5
1.3	TECHNICAL DATA.....	5
1.4	ELECTROMECHANICAL CHARACTERISTICS .....	5
<b>2</b>	<b>I/O RESOURCES .....</b>	<b>6</b>
2.1	KEYBOARD PCB.....	6
2.1.1	LAYOUT .....	6
2.1.2	TOUCH-SCREEN USE .....	6
2.1.3	DISPLAY .....	6
2.1.4	POWER SUPPLY .....	6
2.1.5	ANALOGUE INPUTS .....	6
2.1.6	SERIAL AND CONNECTIVITY.....	6
2.2	CLOCK .....	6
2.3	CONNECTIONS.....	7
2.4	INSTALLATION .....	7
<b>3</b>	<b>USER INTERFACE .....</b>	<b>8</b>
3.1	ICONS DISPLAY .....	8
3.2	SCREENS AND ICONS .....	8
3.3	START PAGE.....	8
3.4	HOME PAGE .....	9
3.4.1	CHILLER/HEAT PUMP PAGE.....	10
3.4.2	FAN COIL PAGE.....	13
3.4.3	AREA Hi-T2 .....	14
3.5	SECOND MAIN PAGE .....	14
3.6	SYSTEM MAIN PAGE .....	15
3.6.1	STATUS SETUP PAGE .....	16
3.6.2	SET-POINT SETUP PAGE.....	16
3.6.3	PROGRAMS PAGE (CHRONOTHERMOSTAT).....	16
3.6.4	SPECIAL FUNCTIONS PAGE .....	17
3.6.5	CONFIGURATION PAGE .....	17
3.6.6	HELP PAGE.....	19
<b>4</b>	<b>MACHINES STATUS AND FUNCTIONS .....</b>	<b>19</b>
4.1	NETWORK MANAGEMENT .....	19
4.2	CHILLER/HEAT PUMPS MANAGMENT .....	20
4.2.1	ENABLING INDIVIDUAL CHILLERS FOR DHW PRODUCTION .....	20
4.3	MANAGEMENT OF FAN COIL UNITS .....	20
4.4	INITIAL CONFIGURATION PROCEDURE OF HI-T2 REMOTE CONTROL PANEL .....	20
4.4.1	ADDRESSING.....	20
4.4.2	NETWORK SCANNING .....	20
4.4.3	ASSIGNMENT OF THE FAN COILS TO THE ZONES AND ZONE NAME CUSTOMISATION .....	21
4.5	SOLAR MANAGEMENT .....	21
4.6	OPERATION OF CONNECTED UNITS.....	21
4.6.1	SWITCHING ON/OFF.....	21
4.6.2	SWITCHING ON/OFF DHW MODE .....	22
4.6.3	SET-POINT SET-UP .....	23
4.6.4	PROGRAMS SETUP (CHRONOTHERMOSTAT) .....	25
4.6.5	ROOM THERMOSTAT .....	27
4.7	KEYBOARD SETTING PROCEDURE.....	28
4.7.1	SETTING OF LANGUAGE AND DATE/TIME.....	28
4.8	DIAGNOSTIC ERRORS.....	29
4.8.1	ACTIVE ALARMS .....	29
4.8.2	ALARM HISTORY.....	29
4.9	DOUBLE SET-POINT FUNCTIONS.....	29
4.9.1	DEW POINT CONTROL .....	30

---

4.10 CLIMATIC COMPENSATION .....31

4.11 OTHER FUNCTIONS.....34

4.12 SPECIAL FUNCTIONS.....34

    4.12.1 SCREED FUNCTION ..... 34

4.13 PASSWORD AND PROTECTIONS .....35

**5 FIRMWARE UPDATE .....35**

**6 HI-T2 CONFIGURATION PARAMETERS .....35**

**7 FAN COIL CONFIGURATION PARAMETERS .....39**

**8 DESCRIPTION OF RFC SYSTEM .....40**

**9 CONNECTION NETWORK.....41**

## 1 GENERAL NOTES

### 1.1 PERMITTED USE

Hi-T2 is a touch screen remote control panel for centralised management of a network of chillers/heat pumps and RFC system. It can also be used for partial functions (i.e. as a remote control panel of a single chiller/heat pump or ambient temperature thermostat for managing the different zones).

It includes humidity and temperature sensors for the thermo hygrometric analysis of the environment and for the management of the double set point for radiant floor heating systems that use a dehumidification system.

The intuitive interface simplifies the use of the controller; all the functions can be easily set through the use of an easy to understand synoptic.

The remote control supervises and periodically examines the network, there is a cycle time that elapses between the signalling or command request and the activation of the function, the cycle time depends on the size of a network of fan coils and heat pumps.

For multi-circuit units, only the resources and parameters of the first circuit are displayed.

### 1.2 PROHIBITED USE

Any use different than that permitted is PROHIBITED.

### 1.3 TECHNICAL DATA

Characteristics	Typical	Min.	Max.
Supply voltage	12Vac	10Vac	14Vac
Supply frequency	50 - 60Hz	Tip-5%	Tip+5%
Operating ambient temperature	25°C	0°C	50°C
Operating humidity (non-condensing)	30%	10%	90%
Ambient temperature for storage	25°C	-20°C	70°C
Ambient storage humidity (non-condensing)	30%	10%	90%
Class of device (EU REG 2013-811)	4		
Contribution of temperature control to the seasonal energy efficiency of heating environment. (REG EU 2013-811)	2%		

### 1.4 ELECTROMECHANICAL CHARACTERISTICS

<b>Terminals and connectors</b>	Screw terminals
<b>Analogue inputs</b>	1 NTC probe on board 1 humidity probe on board
<b>Serial</b>	1 USB Host (per mass-storage plug) 1 Isolated RS485 for chiller/heat pump and fan coils network 1 TTL serial port for future use (optional plug-ins)
<b>Transformer</b>	Device not included
<b>Clock</b>	RTC clock with backup capacitor
<b>Display</b>	LCD TFT 4.3" 480x272 pixel
<b>Keys</b>	Resistive touch screen mounted on the LCD
<b>Overall dimensions</b>	128x81.2mm depth 35mm (box)
<b>Case</b>	In white plastic

## 2 I/O RESOURCES

### 2.1 KEYBOARD PCB

#### 2.1.1 LAYOUT

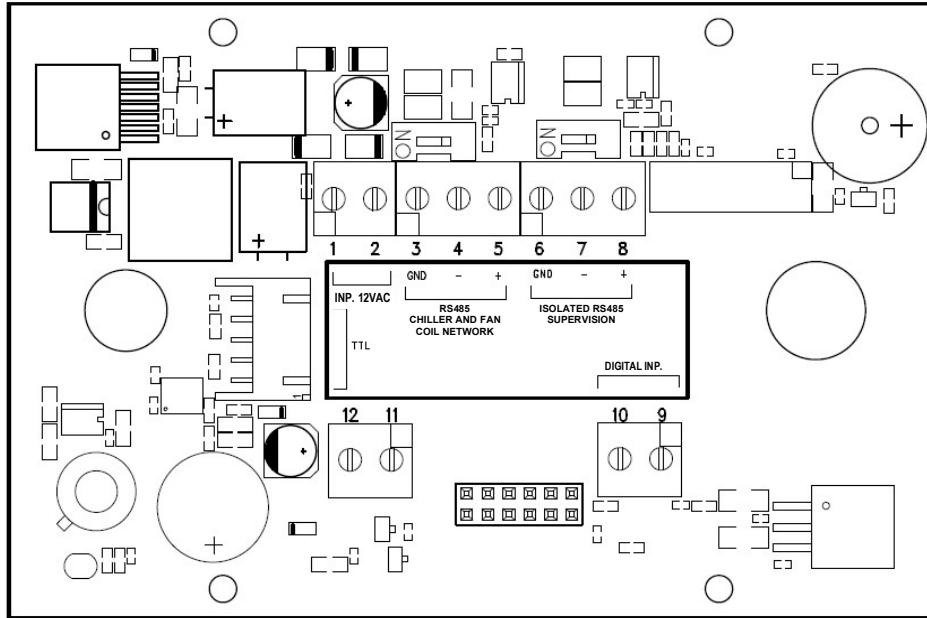

Figure 1. Layout.

#### 2.1.2 TOUCH-SCREEN USE

The interface has a resistive touch-screen on the LCD with sensitive areas applied to the contextual content of the active screen. It allows you to select items or perform functions with ease.

Do not exert too much pressure on the touch screen with your fingers and do not use a sharp object on the touch screen. Doing so may damage the touch screen or cause it to malfunction.

It is advisable to exert weaker pressure and not to act too quickly on the screen and to become familiar with the use of the touch-screen itself, well calibrating the touch of your fingertip on the sensitive areas of the screens.

Do not put the touch-screen in contact with other electrical devices. Electrostatic discharge may cause a malfunction.

#### 2.1.3 DISPLAY

The display is a TFT LCD 16/9 format with a diagonal 4.3". The resolution is 480 x 272 pixels. The LCD is handled with 16bit colour depth (65535 colours).

#### 2.1.4 POWER SUPPLY

Description	Characteristics	ID
POWER SUPPLY 12VAC	12Vac (min. 10Vac – max. 14Vac)	

#### 2.1.5 ANALOGUE INPUTS

Description	Characteristics	ID
Room temperature	NTC probe, conversion range -20°C ÷ +100°C	
Ambient humidity	0% - 90% at temperatures between -20°C and 60°C	

#### 2.1.6 SERIAL AND CONNECTIVITY

Description	Characteristics	ID
USB	USB Host (for mass storage plug) / connector type A	USB
RS485 isolate	Modbus Serial to chiller/heat pump and fan coils	
TTL	Modbus serial TTL for future use	

## 2.2 CLOCK

There is a clock with backup battery.

### 2.3 CONNECTIONS

Terminals 1 and 2: connect 12 V ac power supply (chiller 12V- and 12V+ terminal block).  
Terminals 3-4-5: connect the bus RS-485: terminal 3 with GNDR, terminal 4 with R- and terminal 5 with R+.

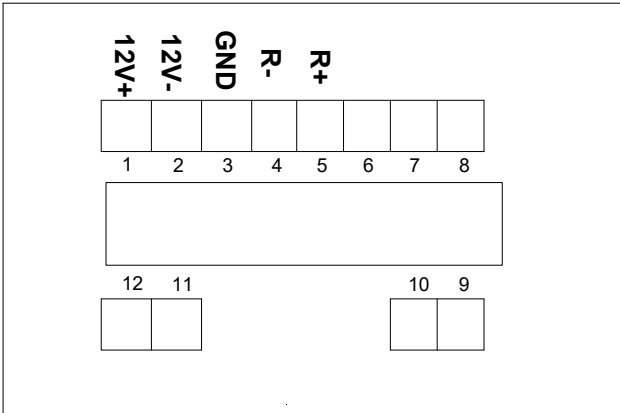

Figure 2. Connections.

### 2.4 INSTALLATION

The Hi-T2 controller can be fixed to the wall according to DIN 503 standard. On its back, there are some pre-drilled holes which can be removed by exerting the required force with a manual screwdriver, in order to get fixing holes. Of the 6 slots, use only the outer 2 slots of the horizontal series (see figure). Before carrying out such operation, open the control panel itself by applying a slight pressure on its lower and upper parts, so as to separate the rear panel from the front panel. Use the rear panel and apply the holes in the two slots shown in the figure below. Do not use the rear panel directly as a template for making holes in the wall, the electronic components may be damaged during this operation.

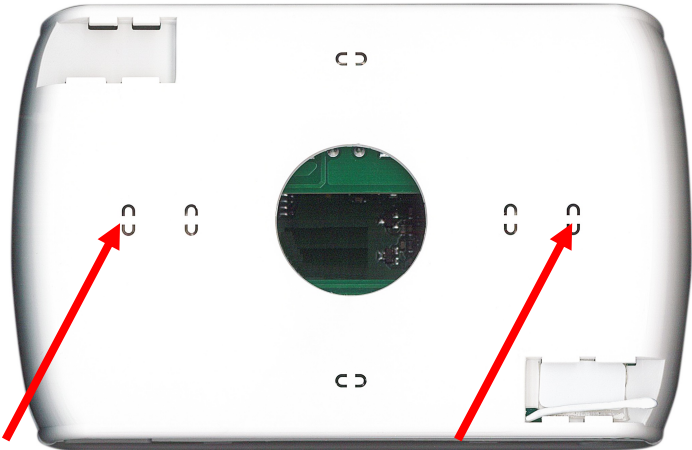

Figure 3. Slots for wall mounting.

### 3 USER INTERFACE

The keyboard can be used in the following ways:

- Interface panel (unit interface) for a single chiller/heat pump.
- Chiller/heat pump network manager
- Chiller/heat pump and fan coil network manager
- Fan coil units network manager

To manage the system modularity, the interface foresees a home page which summarises the whole plant, showing dynamically the enabled resources and hiding the ones not available in the current configuration. The interface also provides a second summary page including all the temperature and humidity values detected in the system.

Through the menu it is possible to have access to:

- Plant configuration
- Single units statuses
- Zone, machine or plant settings

Otherwise it is possible to directly access detailed information from the home page, by pressing on the display where the summarised information is located. E.g., pressing where the main information of the heat pump is located, you can enter in the menu of the heat pump status.

#### 3.1 ICONS DISPLAY

All icons on the different screens can be shown in full colours or faded as in the following example:



The colour saturation indicates that the icon is usable; when pressed the related function is performed. The transparency indicates that the icon is not usable and touching it has no resulting action.

For what concerns the side sliding bar which appears on the left side of the screen related to the single units connected in a network (see Paragraphs 3.4.1.3, if an icon appears fully coloured the related function is enabled and, in that specific moment is also active (i.e. if the “water antifreeze” icon of the heat pump is present and coloured, as shown below, the plate exchanger electrical heaters are switched on).



Instead, if the icon appears but is transparent, the related function is enabled but not currently activated (i.e. if the “water antifreeze” icon of the heat pump appears transparent, as shown below, the plate exchanger electrical heaters are ready to work but currently switched off).



#### 3.2 SCREENS AND ICONS

There might be some differences between screens and icons as they are currently shown. The Company reserves the right to modify and update them without prior notice and in relation to that shown in the present manual.

#### 3.3 START PAGE

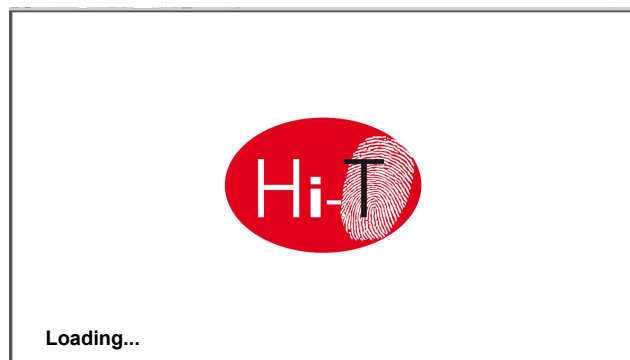

Figure 4. Start page.

When turning ON the Hi-T2 control panel, a splash screen appears with a logo to leave the time needed for loading the system.



### 3.4 HOME PAGE

The home page has the following appearance:

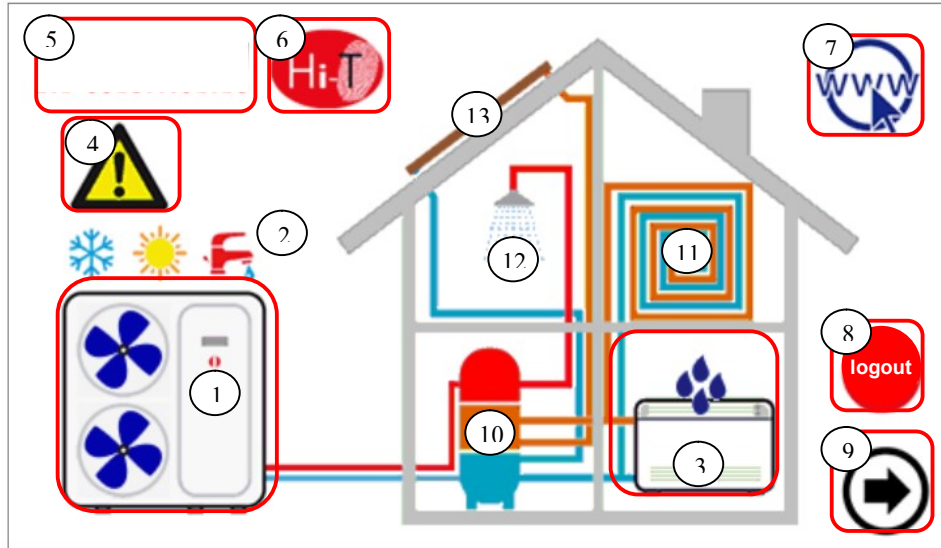

Figure 5. Home page – indication meanings.

From the home page it is possible to access the different device's screens, by simply touching the displayed resource.

The sensitive areas (indicated in the image by red boxes) inside this page are:

1. Chiller/heat pump (for multi-circuit units, only the resources of the first circuit are displayed)
2. System status and mode
3. Fan coil (with a status message of dehumidification active mode)
4. Display of any active alarms in the system
5. Information and location of the company
6. Name of the keyboard (access to information on the firmware version)
7. Log-out (intermittent symbol if active)
8. Navigation arrow, next page.

Graphically, it also contains information on the presence or absence of the following utilities:

10. Storage tanks (plant or whether solar storage tank is present)
11. Radiant panels
12. Sanitary mode
13. Solar.

On the main screen, in fact, only utilities present and properly installed in the network or the active warnings at the time of viewing are displayed.

If, for example, the network consists only of one or more chillers/heat pumps, without production of DHW and without storage tank, the screen graphically shows the presence of the chiller, but no other utilities appear inside the house; in this case the appearance is as below (Figure 6. Home page – only chiller is networked.):

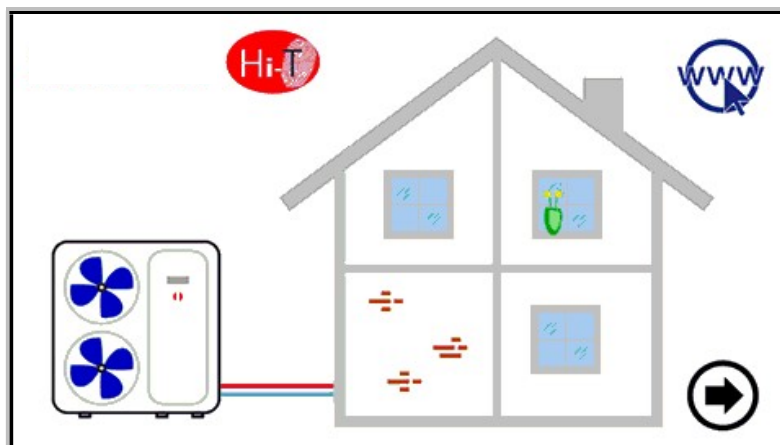

Figure 6. Home page – only chiller is networked.



Figure 7. Chiller/heat pump.

Referring to the above figure, it is possible to obtain the following information:

- presence of networked chillers (if touching the chiller you access the chiller screens);
- operating mode of the chiller (winter ❄️, summer ☀️, DHW 🚰, OFF if none of the previous three symbols appear on the screen);
- operating status of the chiller (compressor running): the operation of the chiller graphically indicated by the rotation of the fans.

Furthermore, the following information on fan coils can be found directly on the home page:

- Presence of networked fan coils, if the fan coil symbol appears (Figure 8. Networked fan coils.);
- Fan coil units in dehumidification mode, if the symbol of the drops on the fan coil appears (Figure 9. Fan coils in dehumidification mode.).

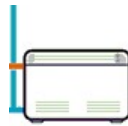

Figure 8. Networked fan coils.



Figure 9. Fan coils in dehumidification mode.

### 3.4.1 CHILLER/HEAT PUMP PAGE

From the home page, touching the chiller symbol (sensitive area number 1, Figure 5. Home page – indication meanings.), grants access to the screen of the chillers present in the network.

From here you can access to the information related to the operations of the chiller; then you can uniquely identify each chiller present by giving them names.

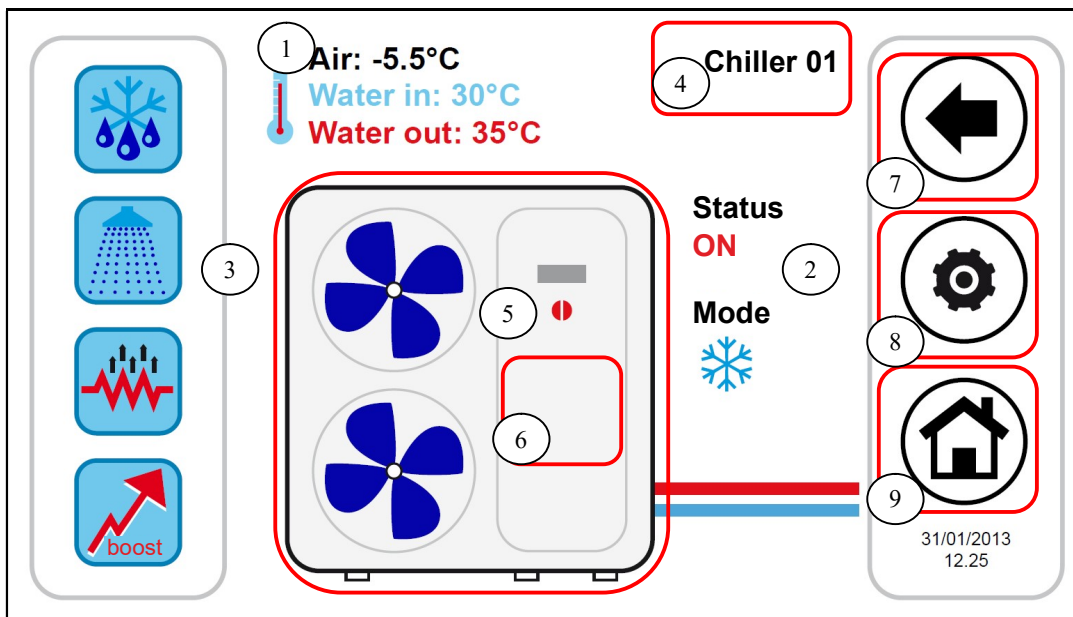

Figure 10. Chiller page – information and sensitive areas.

The information on the chiller's page is:

1. Temperature detected in chillers (for a specific chiller):
  - a. Air temperature (°C)
  - b. Inlet water temperature (°C)
  - c. Outlet water temperature (°C)
2. Status and operation mode for a specific chiller
3. Active/activable functions (in the scroll bar on the left)

Sensitive areas (indicated by red boxes in the figure) in this page are:

4. Chiller name (each time you press on it, you go to the next chiller installed in the network; otherwise, with a long press, you can rename the chiller)
5. Chiller/heat pump (with working signal given by the rotation of the fans); from here you access an additional page of information about that specific chiller
6. Active alarms of the displayed unit
7. Icons of the navigation sidebar
8. Icons of the navigation sidebar
9. Icons of the navigation sidebar

### 3.4.1.1 ASSIGNMENT OF NAMES TO THE CHILLERS

To assign a name to a given chiller, you must browse through the pages of the networked chillers until you reach the page of the specific one whose name you wish to change: for this purpose, press and hold the sensitive area 4 indicated in Figure . Once you find the chiller, press and hold for a few seconds in the same area 4. Compose the desired name with the display keyboard.

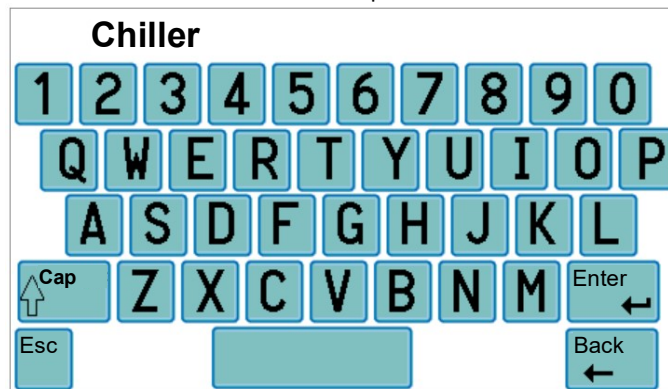



Figure 11. Insert chiller name.

The name of the chiller can have a maximum of 13 characters.

### 3.4.1.2 CHILLER AREA

The area 5 shown in Figure gives indications about the operation (compressor running) of the chiller, graphically displaying the fan rotation ...

Press on the area 5 Figure to get access to a further screen from which you can read the list of the real time data corresponding to the interested chiller such as:

- Inlet water temperature (°C)
- Outlet water temperature (°C)
- DHW probe temperature (if present and configured, °C).

Accessing the same page with service or manufacturer access rights (to enable the access right, press on the “configurations” icon

 in the sensitive area 8 of Figure and set the service/manufacturer password), the data displayed in real-time are:

- Inlet water temperature (°C)
- Outlet water temperature (°C)
- DHW probe temperature (if present and configured)
- High pressure (bar)
- Low pressure (bar)
- Compressor speed (Hz)
- Expansion valve opening (step)
- Fan speed (%)
- Pump speed (%)
- Overheating (°C)
- Compressor operating hours (Hr.)
- Pump operating hours (Hr.)

**3.4.1.3 CHILLER TOOLBAR AREA**

On the left side scroll bar there are icons that symbolise the active/activable functions in the chiller taken into account. In particular:

Coloured icon = function enabled,

Faded icon = function configured on the machine but not currently active.

Below there is a table with icons that may appear in the side scroll bar.

The presence/absence of a certain icon in the sidebar depends on whether it is enabled/disabled on the chiller.











ORDER OF APPEARANCE	ICON	FUNCTION
1		DOMESTIC HOT WATER
2		DHW INTEGRATION HEATER
3		PLANT INTEGRATION HEATER
4		BOILER ENABLING
5		DOUBLE SET-POINT
6		DEHUMIDIFYING
7		SCREED FUNCTION
8		DEFROST
9		ANTIFREEZE WATER
10		ANTIFREEZE TRAY HEATER

Table 1. Order of appearance of the icons in the toolbar on the chiller.

**3.4.1.4 NAVIGATION BAR AREA**

In the toolbar which appears at the right side of the chiller page, you have three icons for navigation between pages, as well as the date and time as shown below:



The first icon on the top allows you to return to the previous screen, the second allows you to enable service or manufacturer access rights through a password to further information in real-time, the last returns to the Home screen.

If an icon appears transparent, it means that is not accessible.

### 3.4.2 FAN COIL PAGE

From the main page, by touching the fan coil symbol (sensitive area number 3, Figure 5), you can access the networked fan coils screen.

From here you may access all the information on operation of the individual fan coils, identified by their zone and identification number of the single fan coil.

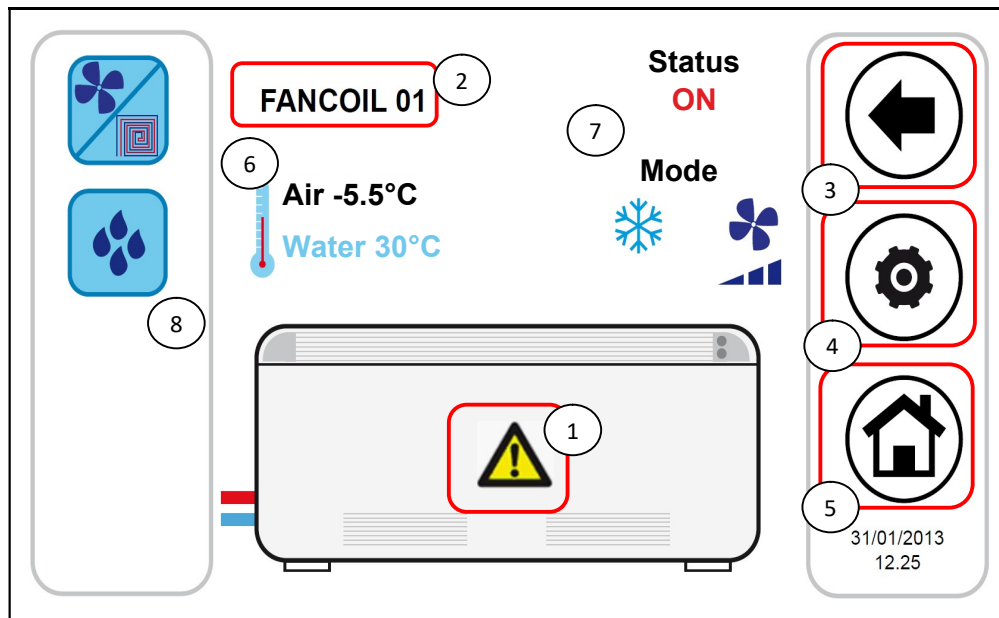

Figure 12. Information and fan coil page sensitive areas.

Sensitive areas (indicated by red boxes in the figure) in this page are:

1. Active alarms of the displayed unit
2. Fan coil name (the name of the zone the fan coil belongs to and the identification number of the fan coil are displayed; every time you press the name area, you go to the next fan coil unit in the network)
3. 4. and 5. Navigation bar

The information on the fan coil page is given below:

6. Detected temperature in the fan coil zones (the average value of the fan coil temperatures in the area)
  - a. Air temperature (°C)
  - b. Inlet water temperature (°C)
7. Status and operating mode related to a specific fan coil (with fan speed)
8. Active/activable functions (in the scroll bar on the left)

By pressing on the configuration button (Sensitive area 4), you can access the fan setting. Ventilation is modified by zone. Therefore changing ventilation of 1 fan coil of a certain area applies the modification to the entire zone. The fan setting page looks like this:

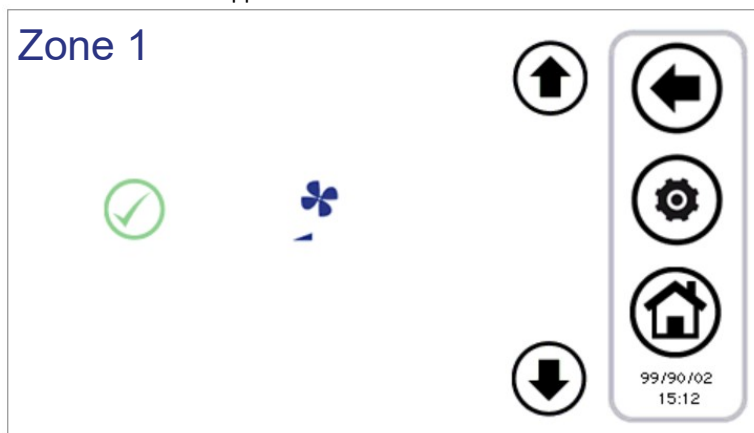



Figure 13. Fan speed configuration.

The selectable speeds are:

- Minimum speed
- Medium speed
- Maximum speed

- Automatic adjustment (auto-mode)

To set the speed, use the up and down arrows, and then press the green button  to confirm the selected speed.

**3.4.2.1 BAR AREA OF FAN COIL FUNCTIONS**

In the left side scroll bar, there are icons indicating the active functions or that can be activated in the concerned fan coil. In particular:

Coloured icon = function enabled,

Faded icon = function configured on unit but not currently active.

Below there is a table with icons that may appear in the side scroll bar.

The presence/absence of the icon in the sidebar depends on whether the function referred to on the fan coil is enabled or disabled.



ORDER OF APPEARANCE	ICON	FUNCTION
1		WINDOW CONTACT
2		DOUBLE SET-POINT
3		HUMIDITY CONTROL

Table 2. Order of appearance of the icons in the fan coils function bar.

**3.4.3 AREA HI-T2**



Pressing on the sensitive area 6 of Figure 5, you have access to a screen showing the version and the date of release of the firmware installed.

**3.5 SECOND MAIN PAGE**

From the home page, touching the navigation arrow to go to the next screen, you access to a second screen showing all measurements carried out by the temperature probes and humidity probes in the system.

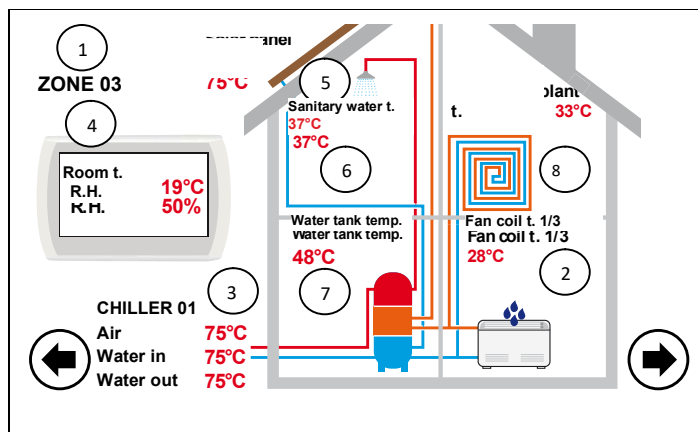

Figure 15. Second Main page.

Referring to the figure above:

- Field 1 indicates the zone to which you are referring. When pressed, you enter the next area, scrolling cyclically through all the setting zones.
- Field 2 indicates the fan coil which is referenced within the zone selected from field 1; by pressing on it the index of the selected zone moves forward in a cyclical manner, indicating all the fan coil units in the area. The detected air probe temperature is displayed for each fan coil. These indications appear only if there are fan coils configured in the system.
- Field 3 indicates the chiller referred to; by pressing on it, you progress to all the other chillers in the network. For each chiller shown, you see the readings of the water inlet and outlet temperatures of the chiller and the air temperature measured by the probes on board.
- Field 4 shows the ambient temperature and the relative humidity measured by the probes integrated in the Hi-T2 panel.
- Field 5 indicates the presence of the solar panel system; then the indication on the temperature of the solar panels is shown. These indications appear only if a solar panel system is configured in the system.

- Field **6** shows the enabling of domestic hot water production related to the selected chiller. It indicates the temperature of the domestic hot water produced.
- Field **7** indicates the presence of a storage tank connected to the selected chiller. The display will show the temperature of the plant storage tank when enabling the water system remote probe. Whereas it will show the temperature of the DHW tank if the domestic hot water production is activated. If solar management is activated, it will display the temperature of the solar storage tank.
- Field **8** indicates the presence of radiant floor panels; this field is linked to the enabling of the double setpoint function.

In the case of faulty probes or not properly configured and/or connected, the error warning appears.

**NOTE:** The presence of DHW tank refers to the fact that there is a heat pump enabled in the DHW mode in the network.

### 3.6 SYSTEM MAIN PAGE

From the second page, touching the navigation arrow to the next screen, you go to a third screen for general settings, the "system main page", showing the following functional icons:



Figure 16. System main page.

Above, from left to right:

- 1) STATUS SETUP;
- 2) SET-POINT SETUP;
- 3) PROGRAMS AND CHRONOTHERMOSTAT.

At the bottom, from left to right:

- 4) SPECIAL FUNCTIONS;
- 5) CONFIGURATION;
- 6) HELP MENU.

**3.6.1 STATUS SETUP PAGE**



Press the button to enter the "Status setup" page.

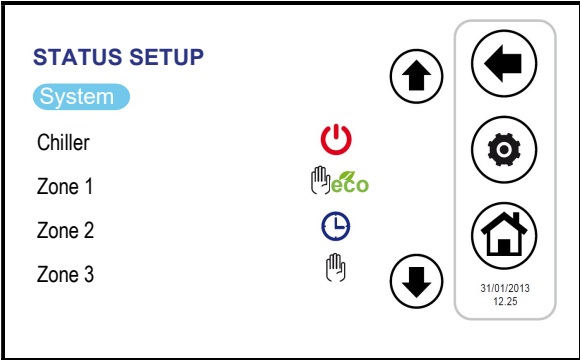

Figure 17. "Status setup" page.

Pressing "System", you can set the status of the entire system, otherwise you can act on the individual units.

**3.6.2 SET-POINT SETUP PAGE**



Press the button to enter the "Set-point setup" page.

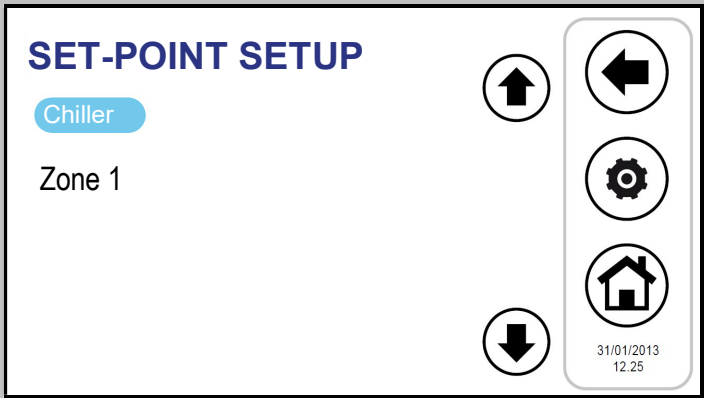

Figure 18. "Set-point setup" page.

From this screen you can set the parameters of the chiller and of the configured fan coil zones. If enabled, you can also set the domestic hot water setpoint (see Paragraph 4.6.2) and for rapid DHW preparator, the second set-point (see Paragraph 4.9) and the offset for climatic compensation (see Paragraph 4.10).

**3.6.3 PROGRAMS PAGE (CHRONOTHERMOSTAT)**



Press the button to enter the "Programs" page.



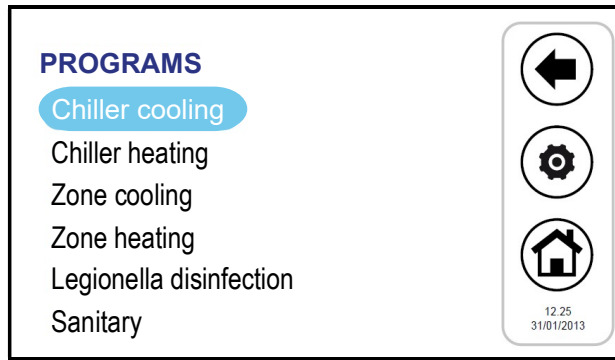

Figure 19. "Programs" page.

From this page you can separately set the weekly program of each chiller and fan coil zone. You can also program the legionella cycle and the production of domestic hot water, if enabled (see Paragraph 4.6.4).

### 3.6.4 SPECIAL FUNCTIONS PAGE



Press the button to enter the "Special Functions" page (see Paragraph 4.12).

### 3.6.5 CONFIGURATION PAGE



Press the button to enter the "Configuration" page.

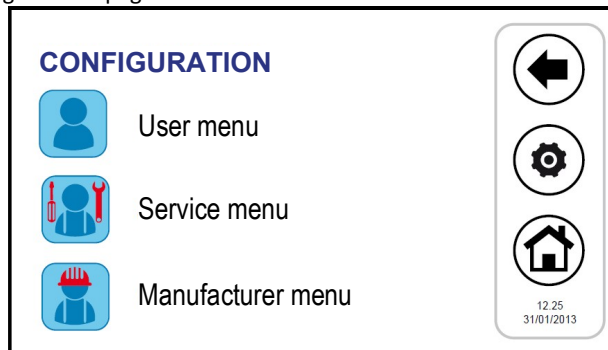

Figure 20. "Configuration" page.

From the configuration screen, you can access the User-Keybaord setup menu, the Service menu and the Manufacturer menu. Pressing each of these items; a numeric keypad will appear for entering a password.

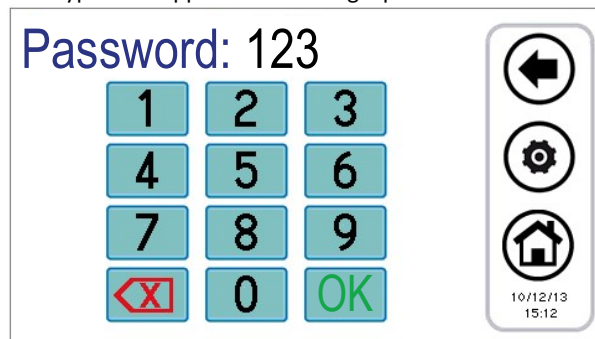

Figure 21. Password entry.

The user password is set by default to "0" (modifiable).

#### 3.6.5.1 USER MENU – KEYBOARD SETUP

To access the user menu the user password must be set up (modifiable): **0**.

From here you can:

- Set the date and time by pressing on "Clock" key (it appears on the screen shown in Figure );
- set the language by pressing on "Language";
- access the setup of the keyboard, pressing on "Parameters".



Figure 22. Date and time setting page.

It is possible to change the setup of the keyboard according to the parameters shown in the following table:

N.	PARAMETER NAME	UNIT OF MEASUREMENT	DEFAULT VALUE	MINIMUM VALUE	MAXIMUM VALUE
1/3	User password	Num	0	0	999
2/3	Backlight intensity	%	5	0	100
3/3	Screensaver unlock Psw	Num	0	0	999

Table 3. User Menu Parameters (keyboard setup).

To change the value of a parameter:

- having entered in "Parameters", use the up and down arrows to scroll through the pages of the parameters, until you find the desired parameter;
- press on the currently set value;
- the current value turns red to indicate that it can be changed by using the up and down arrows;
- select the desired value and press the confirmation tick

**Note:** If you press outside the confirmation area, it will go back to the previous value.

### 3.6.5.2 SERVICE MENU

In order to access the menu, you must set the service password.

From here you can:

- configure the network, by pressing the button "Address configuration";
- configure zones, by pressing the button "Area Configuration";
- access the service parameters of the Chiller, Hi-T2 and fan coils, by pressing "Parameters";
- access the alarm history, by pressing on "Alarm log".

The screens shown are as follows:

1. Address configuration
  - 1.1. Assign addresses
  - 1.2. Scan network
2. Configuration of zone 01
  - 2.1. Zone 01
  - 2.2. Zone 02
  - 2.3. Zone xx
3. Service parameters
  - 3.1. Chiller
    - 3.1.1. Chiller 01
    - 3.1.2. Chiller 02
    - 3.1.3. Chiller xx
  - 3.2. Keyboard
  - 3.3. Fan coil
4. Alarm log

### 3.6.5.3 MANUFACTURER MENU

To access the manufacturer menu you must set the manufacturer password.

From here you can:

- access the manufacturer parameters of the Chiller, by pressing "Chiller";
- access the manufacturer parameters of the Hi-T2, by pressing on "Keyboard".



The help page gives guidance on the meaning of the buttons; in the list that appears, the function of each icon is indicated.

## 4 MACHINES STATUS AND FUNCTIONS

### 4.1 NETWORK MANAGEMENT

A network managed by the remote control Hi-T2 can be composed of a maximum of 7 chillers/heat pumps and a maximum of 80 fan coil units. As for the configuration of the network, you have the following functions as indicated below:

- fan coils addressing procedure;
- automatic scanning of the network to discover devices;
- radiant panels management (according to the set-point).

#### REMOTE CONTROL CONNECTED WITH SEVERAL CHILLERS IN THE NETWORK

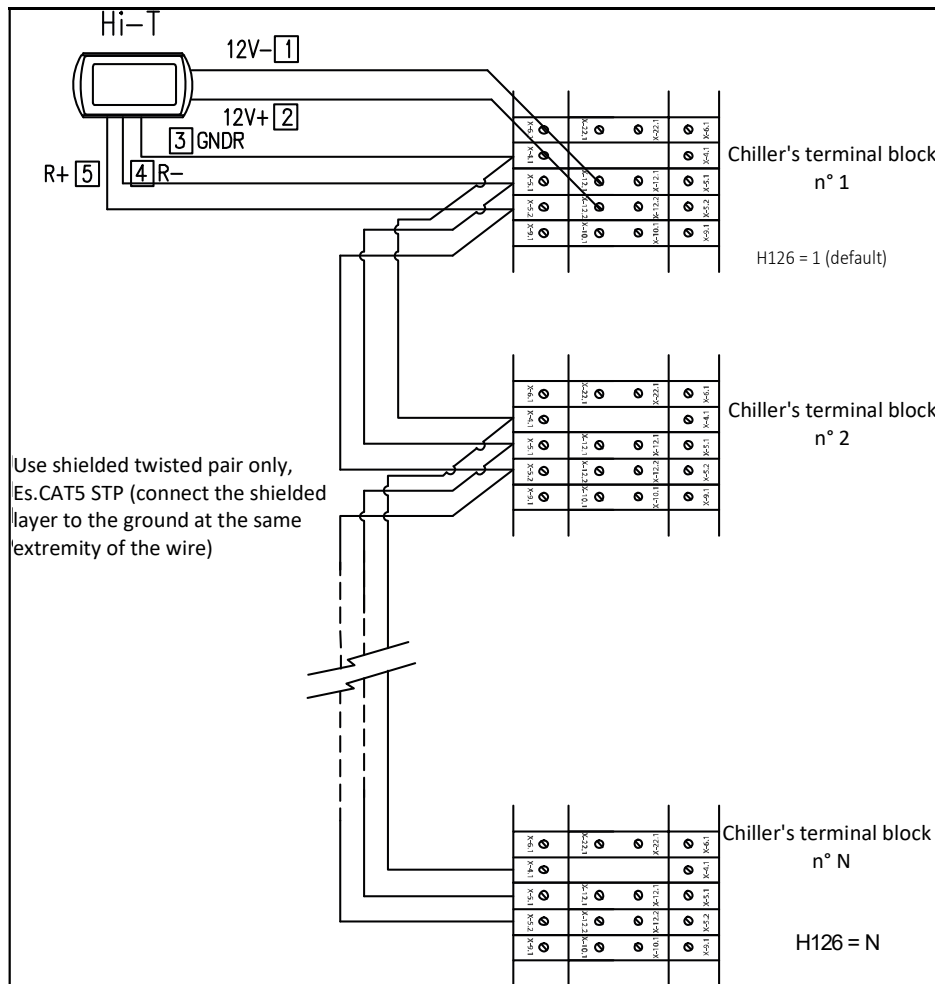

In the each on-board control panel, set the chiller address (parameter **H126**) as described above.

Then connect the chiller and the Hi-T2 remote control as shown in the drawing.

In the Hi-T2 remote control, by setting the parameter **Par 8/65** (*Configuration -> Service Menu > Keyboard*) related to the number of chillers in the network, you can configure the network: with **Par 8/65 = 0** all the chillers in network feature a similar operation (parallel operation, according to a single set point), while with **Par 8/65 ≠ 0** we have a decalibration on the steps of the chiller set points, allowing a cascade operation. In particular, the parameters to be set in a network of chillers to be configured in a cascade are:

- **Par 8/65**: number of chillers in the network (for cascade operation);
- **Par 9/65**: (default 1 hour.): rotation period (for cascade operation);
- **Par 10/65**: (default 2.0°C): chiller differential (for cascade operation).

In the case of cascade configuration (**Par 8/65 ≠ 0**), the set point of each chiller is changed by a multiple value of the parameter **Par 10/65** (°C) (chiller differential), according to a step-decalibration. After each period equal to **Par 9/65** minutes, the priorities for the

intervention of the chillers change, by rotating the decalibration of the set point of the chillers, in order to balance the load on the various machines. If a chiller is in alarm, it is excluded from the regulation. By default **Par 8/65=0**.

## 4.2 CHILLER/HEAT PUMPS MANAGEMENT

Up to 7 chillers (I-32V5) can be controlled by the Hi-T2 remote control. The main functions that can be adjusted are:

- ON/OFF command;
- Change of season (summer, winter, summer with DHW mode, winter with DHW mode, DHW mode);
- Set-point setup;
- Display of current alarms;
- Alarm history residing in the keyboard with the date and the time of the event;
- Access to the parameters of the chiller (password protected);
- Display of the main statuses of the chiller;
- Weekly programming in summer, winter, DHW mode and of the legionella disinfection cycle.

### 4.2.1 ENABLING INDIVIDUAL CHILLERS FOR DHW PRODUCTION

Among the chillers (in the network) that are enabled to produce domestic hot water, you can choose using the appropriate sub-menu in "*Status setup*", which of these may participate in DHW production (see Paragraph 4.6.2). Only those selected will be enabled for the production of DHW, all the others are used exclusively for the plant.

## 4.3 MANAGEMENT OF FAN COIL UNITS

With the Hi-T2 remote control panel, we can manage up to 80 fan coils of our production equipped with an RFC module, divided into a maximum of 9 zones. Note that the fan coil settings can be done for individual zones (not for individual units). The main functions that can be adjusted are:

- ON/OFF (of the system and/or of the zone with relative scheduler);
- Season (of the system);
- Fan speed (fan coil of the zone);
- Dehumidification control.

The set-point will be sent also to the fan coils of the zone they belong to. Note that a correction can be made locally by means of the fan coil's knob.

## 4.4 INITIAL CONFIGURATION PROCEDURE OF Hi-T2 REMOTE CONTROL PANEL

Note: For easier installation and interfacing of the keyboard with the hydronic terminals, it is recommended to separately power on the terminal units; each terminal unit must be cut off by its own disconnecter.

### 4.4.1 ADDRESSING

During the first startup step, it is necessary to power on each hydronic terminal separately. The addressing process takes place respecting the following steps:

1. a unique address should be assigned to each water terminal unit on the network, to do this, you can use the dip switches situated on the RFC module (first valid address is the value 10). See the relative manual (MCO0113710300 FAN COIL REGULATOR).

In the case of addressing beyond the value 32, it is necessary to set an address lower than 32 using the dip-switches and acting on the parameter 23 of the concerned fan coil. Once the parameter has been configured, set the dip switches in a definitive way and restart the water terminal unit. See the relative manual (MCO0113710300 FAN COIL REGULATOR).

2. Each fan coil must have a unique address. It is important to assign consecutive addresses to the fan coils of the same zone (e.g. if there are 3 fan coils inside the same hall and you want to associate them to a single thermal zone called for example HALL, you need to assign the fan coils with a series of addresses from 10 to 12, etc.);
3. once all the fan coils have been configured, they should be powered on;

### 4.4.2 NETWORK SCANNING

Once the addressing has been done for each fan coil, it is necessary to perform a network scanning to check if all the fan coils are correctly recognised. To do this:

1. power on all the fan coils;

From the system main page, go to "*Configuration*" ;

2. enter the "Service menu"  ;
3. enter the service password and press on the confirmation tick.
4. Enter in "Network scanning";
5. press the confirmation tick near the word "Start:" and wait the system to scan the network;
6. at the end of scanning phase, the system should find all the chillers (max 7 in cascade) and all the fan coil units of the same network. If the number of fan coils found does not match those installed, then the wiring is not done correctly. If one or more fan coils that were correctly addressed and detected disconnect from the network (for example in case of fan coil power failure), the centralised keyboard proceeds with updating the number of fan coils actually in operation in the system with a delay of 2 minutes from the occurrence of the failure, displaying an Error message after the update. When the disconnected fan coils are reconnected, the centralised keyboard recognises them automatically, preserving the previous settings.

**4.4.3 ASSIGNMENT OF THE FAN COILS TO THE ZONES AND ZONE NAME CUSTOMISATION**

To associate the fan coils to the desired zones, it is necessary to follow the procedure below:

1. enter the "Configuration" page and from there in the "Service Menu" following the same procedure as in Paragraph 4.4.1 (points 2-4) and select "Zone configuration";
2. press "Zone 1";
3. press on the second line where the actual name "Zone 1" appears and change the name of the zone using the keyboard which appears on the screen (you can enter a maximum of 9 characters);
4. to confirm the new name press "Enter", otherwise press "Esc";
5. press on the value that appears near the wording "From" (the value is highlighted in red);
6. use the arrows keys to select the address of the first fan coil of the zone that you are configuring;
7. press the confirmation tick;
8. press on the value that appears near the wording "To" (the value is highlighted in red);
9. use the arrows keys to select the address of the last fan coil of the zone that you are configuring;
10. press the confirmation tick;
11. repeat the operations from number 2 to number 10, applying the same procedure to the other zones that you want to configure.

**4.5 SOLAR MANAGEMENT**

This function is not totally configurable by the Hi-T2 controller. It is necessary to act directly on the chiller/heat pump controller by setting the parameters H85 at 39, H86 at 38 and H103 at 30. The enabling is definitive by configuring the parameter S01 at 1 and configuring the relative S parameters also by means of the Hi-T2 remote controller.

**4.6 OPERATION OF CONNECTED UNITS**

**4.6.1 SWITCHING ON/OFF**

When the zones have been configured and the fan coils associated, you may proceed with the "first start-up" of the connected units. With just one touch, you may switch on or off the entire system from the single Hi-T2 keyboard or switch on the chillers and manage the zones individually.

To operate the entire system:

from the main page of the system, go to "Status setup"  ;

1. the following are listed in the menu: SYSTEM, CHILLER, ZONE -th.
2. Press "System" and with a single operation, you can turn on or off all the fan coil units of all zones that are connected to the remote control panel Hi-T2 and all chillers of the same plant:

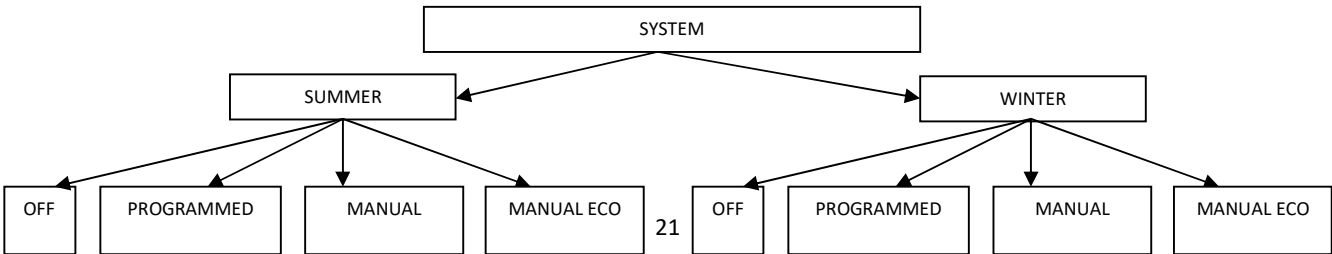

With "Manual" and "Manual eco" the temperature set in the menu "Water setting" and "Eco water setting" is activated; they respectively correspond to the temperature of "normal" operation (1st set-point) and to the working temperature during the energy-saving operation (set-point economy) of the various zones/rooms.

By accessing "Status setup" and pressing on "Chiller" you can only manage the concerned chillers:

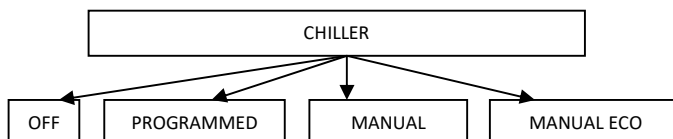

With "Manual" and "Manual eco", the temperatures set in the menu "Water setting" and "Eco water setting" are activated; they correspond respectively to the temperature of the outlet water of the chiller during normal operation and during the energy-saving operation (E.g: in summer mode "Set water" could be 7°C, while "Set water eco" could be 10°C).

After getting access to "Status setup" and pressing on "Zone1" it is possible to control each individual zone separately (for example, starting zone 1 is not a sufficient condition for starting up the chiller if it is off):

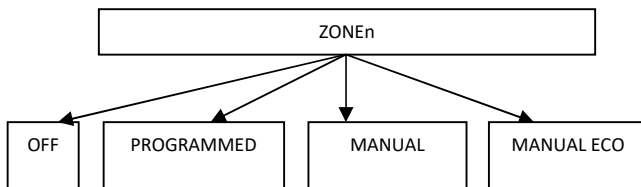

With "Manual" and "Manual eco" the temperature set in the menu "Water setting" and "Eco water setting" is activated; they respectively correspond to the temperature of "normal" operation (1st set-point) and to the working temperature during the energy-saving operation (set-point economy) of the various zones/rooms.

Once you have set the status, in the "Status setup" screen the following icons may appear near the units/zones set:



Another way to set only certain zones/units in a given status can be as follows:

1. set "System" in the manual, manual eco or programmed mode;
2. switch OFF the units/zones that you do not want to activate.

The icon of "Thermostat not active" indicates the status of the room thermostat function of the Hi-T2 control panel. To enable the thermostat function, press the corresponding icon. For the settings related to the function please refer to paragraph ROOM THERMOSTAT.

**Note:** once the status is set from the Hi-T2 control panel, you must wait about a minute to ensure that communication with the on-board controls of the units in the network is successful and the units themselves are activated in the set status.

#### 4.6.2 SWITCHING ON/OFF DHW MODE

If the DHW mode is enabled (from System main page -> Configuration -> Service Menu -> Parameters -> Chiller -> Chiller name -> **H10: DHW presence = 1**), the word "DHW mode" also appears in "Status setup" menu. From here you can decide which chiller to enable to produce the domestic hot water:

1. enter "Status setup", then "DHW";
2. On the next screen select "All" to enable all the chillers for DHW production, or select only the chiller interested in this production (the others will be used exclusively for the plant);
3. Confirm by pressing the confirmation tick in the upper right area;

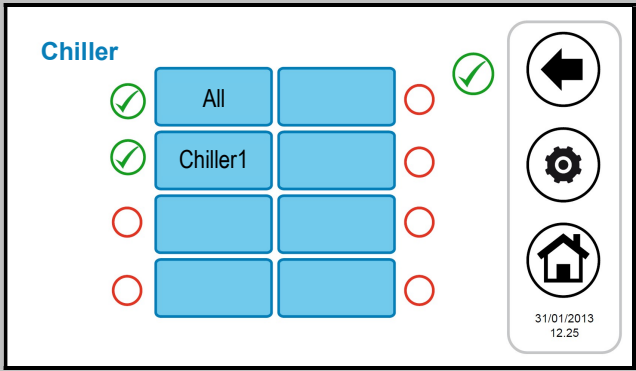
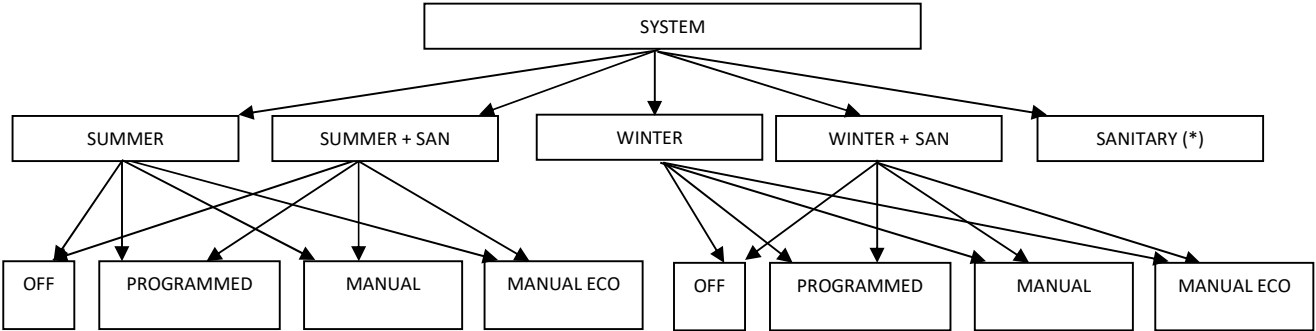

Figure 23. Chiller choice for DHW production.

- In the "System" menu (system main page -> "Status setup" -> "System"), with the DHW mode enabled by the parameter H10, the words "Winter + san", "Summer + san", "Sanitary" appear.



- If the status of the system is set to "Summer + san" or "Winter + san", the priority is given to the production of domestic hot water; therefore the system goes first to domestic hot water production, when the DHW is satisfied, the system switches the mode to summer or winter operation.

(\*) If from: System main page -> "Status setup" -> "System" you select only "Sanitary":  
 to put the DHW at "OFF" or "Programmed" or "Manual" mode, go back to "Status setup", enter "Chiller" and from there select the status (in this case both "Manual" and "Manual eco" set the chillers in DHW manual mode).

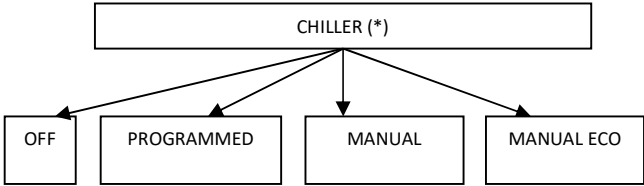

**Note:** once the DHW status is set from the Hi-T2 control panel, you must wait about a minute to ensure that communication with the on-board controls of the units in the network is successful and the units themselves are activated in the set status.

**4.6.3 SET-POINT SET-UP**

Management procedure of the set point of the different zones and chillers:

- from the system main page, go to "Set-point setup" ;
- at this point, you find a list of chillers and the areas that were previously assigned:
  - CHILLER
  - ZONE1
  - ZONE2
  - .....
- select the concerned chiller or zone;
- the possible settings are "Winter", "Summer", "Sanitary" for the chiller, "Winter" and "Summer" for the fan coil zones:

CHILLER

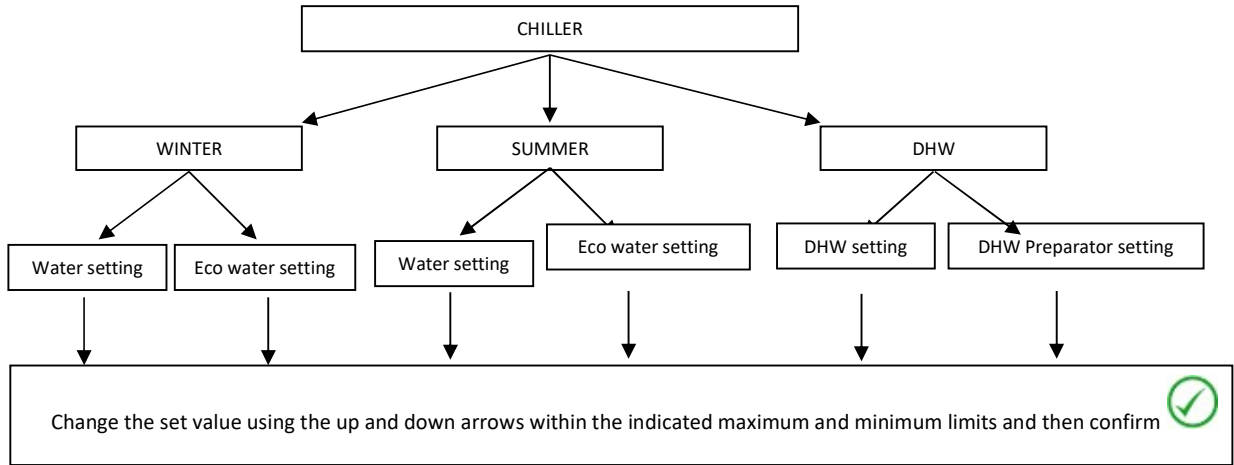

ZONE -th

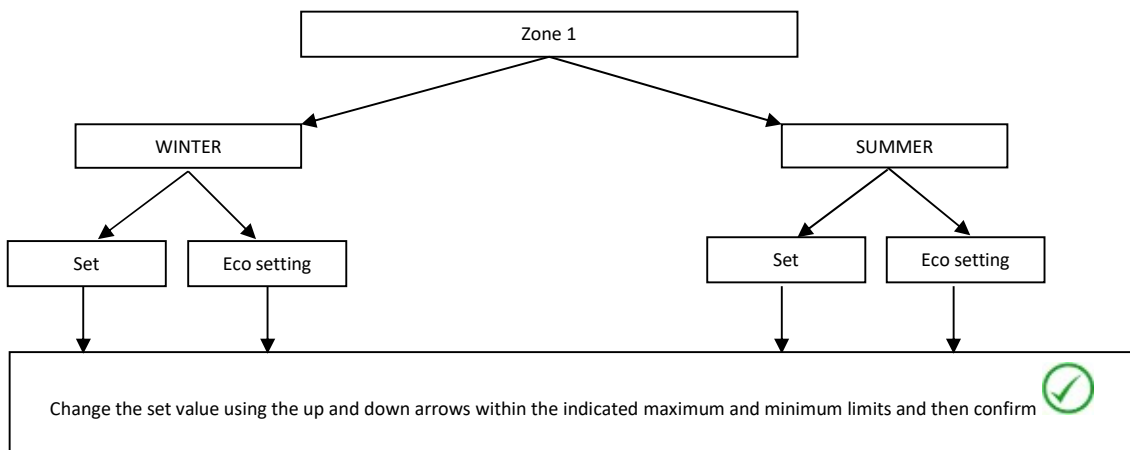

If the double set-point is enabled (from System maintained -> Configuration -> Service Menu -> Parameters -> Chiller -> Chiller name -> **H129: Enable second setpoint = 2, 3, or 4**), (see Paragraph 4.9), the possible settings for the chiller are:

DOUBLE SET-POINT

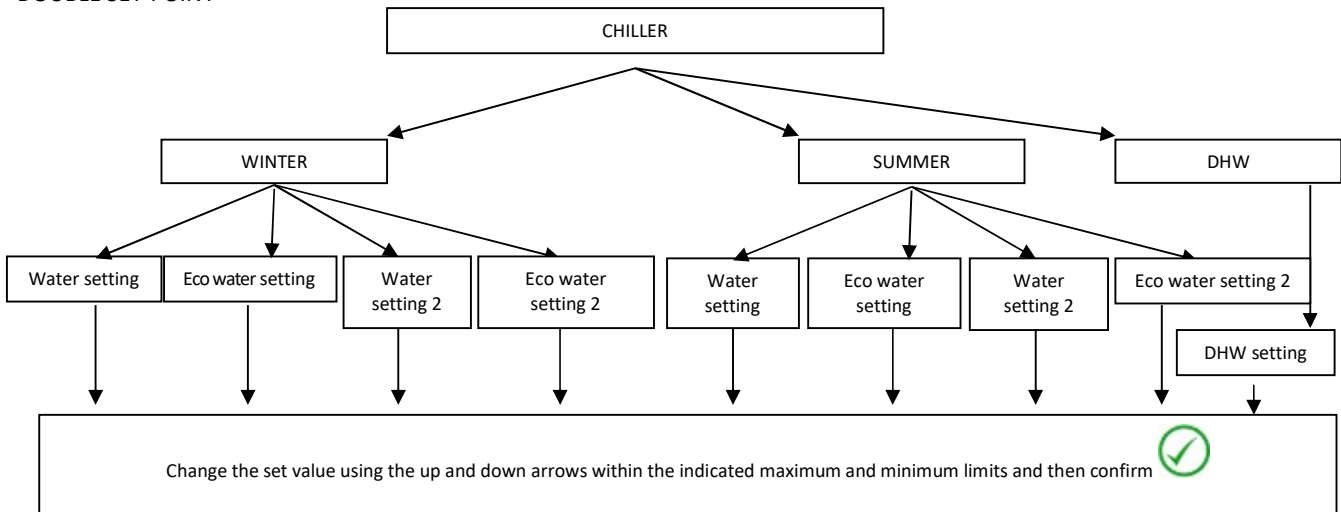



#### 4.6.4 PROGRAMS SETUP (CHRONOTHERMOSTAT)

The chronothermostat programming takes place separately from the chillers and fan coil terminal units: so it is necessary to program both the switching on and off of the chillers, and the switching on and off of the zones to which the fan coils are associated; the starting-up of a programmed zone is not a sufficient condition for the startup of the chiller(s) connected in parallel to the plant.

From the main page of the system, go to "Programs".  ;

Now you can choose between 4 programs:

- "Summer Chiller", to set the weekly time programming of chillers in summer mode;
- "Winter Chiller", to set the weekly time programming of chillers in winter mode;
- "Zones summer", for setting the weekly time programming of the zones in summer mode,
- "Zones winter", for setting the weekly time programming of the zones in winter mode;

In addition, if DHW mode is enabled (from System main page-> Configuration -> Service menu -> Parameters -> Chiller -> Chiller name -> **H10: DHW presence = 1**), you can access to two other programs:

- "DHW mode" to set the weekly time programming mode of the chiller in DHW mode.
- "Legionella" to set the weekly time programming of the legionella disinfection cycle.

##### 4.6.4.1 WEEKLY CHILLER PROGRAMMING

The chillers can be defined on seven days, independently and with minimum steps of 15 minutes, with the following operating status:

- Off
- Normal operation (use of normal water control settings)
- Economical operation (use of the economic water regulation settings)

The weekly programming in summer operation is distinct from that in winter mode.

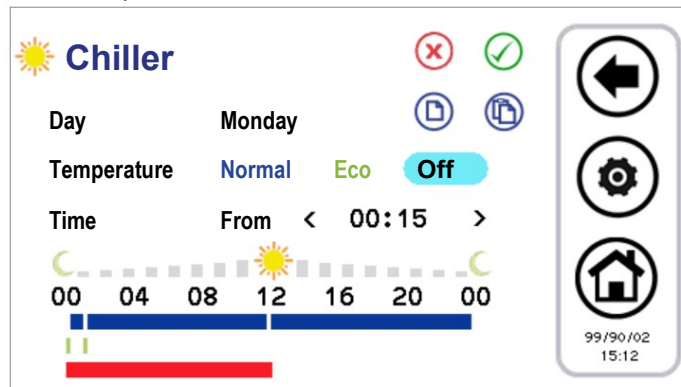









Figure 24. Chronothermostat, "Summer Chiller" page.

##### 1. Scheduling of day time slots:

- press on the day currently displayed to move to the next day;
- choose if you want to set an operation time slot in normal mode (press "Normal"), or Economy (press "Eco"), or if you want to set to Off (press "Off");
- check that the word "From" appears after "Time" (if instead the word "To" appears, you need to press it once to display the word "From") and select the hour and minutes (the minimum allowable variation is 15 minutes) for the beginning of the time slot;
- press "From" once so that the word "To" appears and select the hour and minutes (the minimum variation permitted is 15 minutes) for the end of the time slot;
- confirm the single time slot by pressing the green confirmation symbol at the top right ;
- afterwards you can observe that, corresponding to the selected time slot, you will see a time-line bar of the colour of the type of the selected setting (if normal blue, green when in economy mode, no bar in "Off");
- repeat the above steps for all the time slots that you want to set on that particular day.
- To exit and save the changes you have made (on the whole program, for all week), press the ESC  button, while if you press the Home  button, you will exit without saving the changes.

##### 2. It is possible to copy the programming for a particular day to another day; to do this:

- select the day whose programming you want to copy;
  - press the copy icon ;
  - select the day on which you want to copy the scheduling;
  - press the paste icon .
3. It is possible to erase the programming of certain days or of all days, to do this:
- press the delete icon ;
  - at this point a screen will appear where you can select individual days to delete or select all the days;
  - to confirm your selections, press the confirmation tick on the top right .

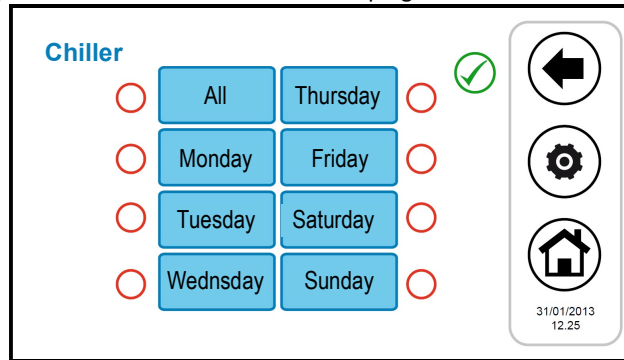

Figure 25. Chronothermostat, erase programming page.

The chronothermostat configuration pages show coloured time-lines: the blue time-line indicating normal operation, the green time-line indicating economical operation, the red time-line indicating the time in which the legionella cycle is programmed (thus the machine in that condition may be active even if the scheduler is set to Off).

**4.6.4.2 FAN COIL ZONES WEEKLY PROGRAM**

In a similar way to what is reported for scheduling the chillers, you can set the weekly program of each individual zone (independently for summer and winter) with a 15 minute resolution.

The possible settings are:

- Zone off;
- Zone in normal operation (normal ambient setpoint);
- Zone in economical operation (eco ambient setpoint).

Then entering "Summer Zones" or "Winter Zones" a list of all set zones will appear. At this point you must select the zone you want to set; the configuration of the chronothermostat is the same as seen for the chillers. Indeed the graphical appearance and features on the page are identical to those already described.

**4.6.4.3 DHW PRODUCTION WEEKLY PROGRAM**

In a similar way to what is reported for scheduling the chillers and fan coils, you can set when to enable domestic hot water production (by setting the individual days of the week, with a 15 minute resolution). The following settings can be made:

- Normal: Function active;
- Off: Function not active.

To perform the programming, enter "Programs" -> "DHW" (the text "DHW" only appears if DHW mode is enabled from: System main page -> Configuration -> Service menu -> Parameters -> Chiller -> Chiller name -> H10: DHW presence=1).

Configuration of the chronothermostat is therefore similar to that described above, with the only difference that you must select between "Normal" and "Off" (see figure below).

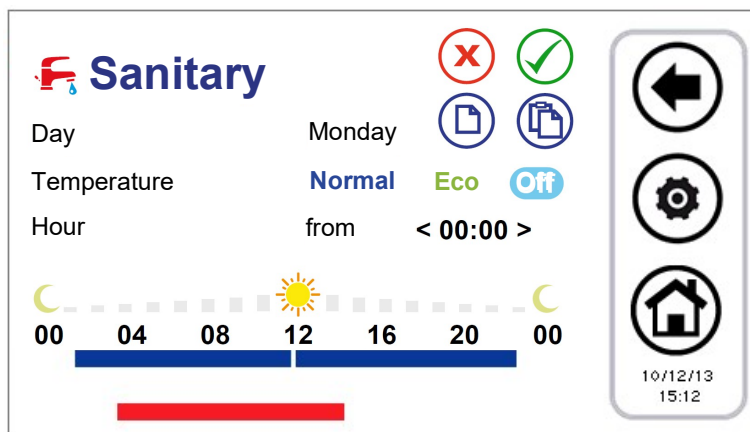

Figure 106. Chronothermostat, "Sanitary" page.

In the time slots where the function is active, the machines enabled to DHW production are set in the seasonal mode foreseen by the plant scheduler of the chillers with the addition of DHW mode, namely respectively:

- Summer + DHW
- Winter + DHW
- DHW only

**4.6.4.4 ANTILEGIONELLA DISINFECTION CYCLE WEEKLY PROGRAMMING**

If the sanitary function is enabled (from system main page -> Configuration -> Service menu -> Parameters -> Chiller -> Chiller name -> **H10: DHW presence = 1**), you can program the times of the individual days of the week for the anti-legionella disinfection cycle. You select only the starting time (with 15 minutes steps), since the duration of the cycle is defined by a parameter with service access rights (System main page --> Configuration -> Service menu -> Parameters -> Keyboard -> **Par 31/65: Legionella disinfection duration**).

To carry out the programming you must enter "Programs" -> "Antilegionella"; the procedure is simple because you only need to select the cycle starting day and time (see Picture below).

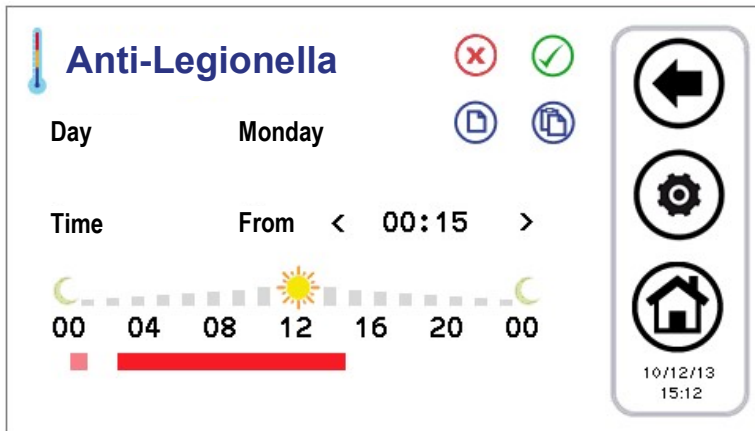

Figure 27. Chronothermostat, "Antilegionella" page.

The set timeline appears red-coloured.

The pink line shows any setting of the previous day that overruns into the present day because the duration exceeds midnight.

It is necessary to enable the electric heaters in DHW integration, by setting the parameter **R15 = 1**.

**OPERATION:**

- When the anti-legionella cycle is expected, the heat pump unit changes AUTOMATICALLY to DHW mode in order to reach the setting values of the parameter R27 (50°C)
- When the DHW temperature probe meets the value of **R27**, the compressor will stop operation and the DHW electric heater (DO = 26) will start after **R16** (1min)
- The DHW electric heater turns off if one of the following conditions is met:
  - The DHW probe detects a temperature = **R25** (80°C), hysteresis 'cut-on' of 1°C.
  - The programmed cycle finishes.

**4.6.5 ROOM THERMOSTAT**

The Hi-T2 control panel can operate as a typical room thermostat.

Zone 1 is always present.

The room thermostat function will be enabled/disabled for each zone using the corresponding button at the bottom of the zone status setting screen.

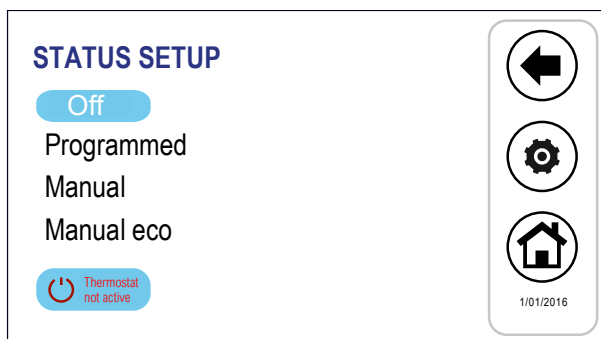

Figure 28. Status setup

The thermostat activation key has two states depending on whether the function is enabled or disabled.

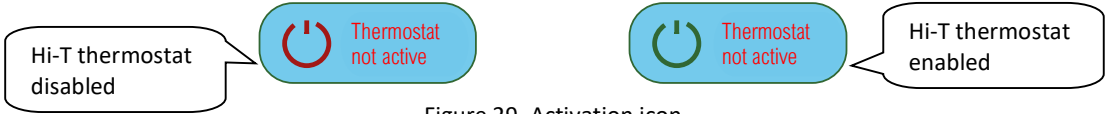

Figure 29. Activation icon

When the icon shows the message "Thermostat not active" (default) this means that the temperature control of the reference zone is performed with the remote air temperature probe of the fan coil unit or if the RFC is present.

To activate the room thermostat function in the zone:

- 1) Press the activation icon, displaying "Thermostat active".
- 2) Select the mode in which temperature control of the reference zone shall be carried out by setting the parameters from **P48 to P56** for winter and from **P57 to P65** for summer. See Chapter 6.

The call of the room thermostat shall be active when the setpoint of the zone is not reached, the heat pump is enabled for operation.

The call of the room thermostat is disabled when the temperature detected by the Hi-T2 thermostat is greater than the zone setpoint, and the heat pump is in standby mode.

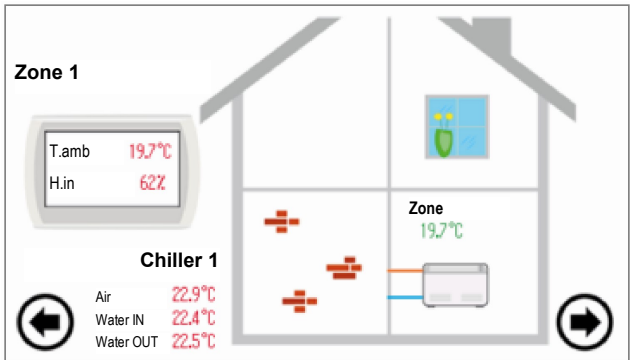

Figure 30. Second Main page.

On the individual fan coil screen, the displayed temperature is the one given by the temperature probe of the fan coil unit (RFC accessory) and not the one used for temperature control.

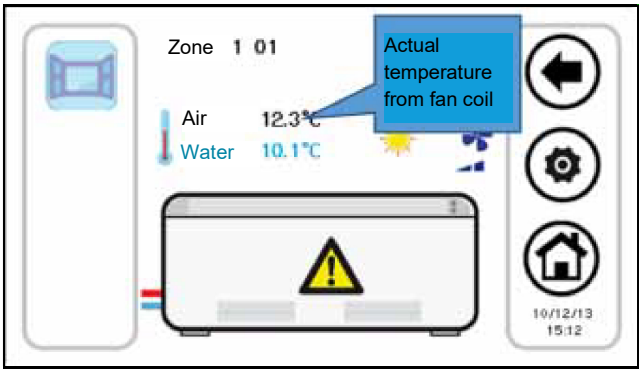



Figure 31. Fan coil page

**4.7 KEYBOARD SETTING PROCEDURE**

**4.7.1 SETTING OF LANGUAGE AND DATE/TIME**

To set the keyboard language:

1. From the system main page, go to "Configuration"  ;
2. enter "User menu"  ;
3. enter the user password and press the confirmation tick (the default password is 0);
4. enter "Language";
5. Select the desired language between Italian, English, French, German and Spanish.

To set the date and the time of the keyboard:

1. from the system main page, go to "Configuration" -> "User menu";
2. enter the user's password and press the tick key to confirm;

3. enter "Clock";
4. set date and time using the arrows (the values to adjust will be red-coloured);
5. when all values are set, press the icon with the tick to confirm.

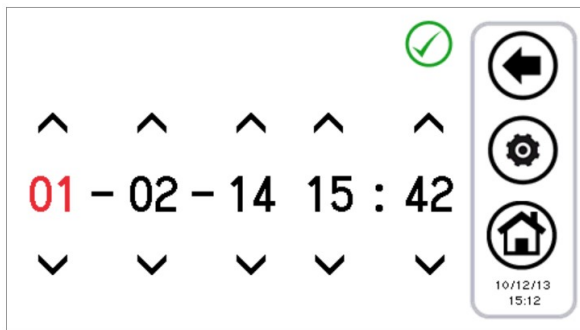

Figure 32. "Clock" page.

## 4.8 DIAGNOSTIC ERRORS

### 4.8.1 ACTIVE ALARMS

You can view the current alarms of the connected units. To do this, from the home page, press the danger triangle icon, if present; from here you can access the list of all active alarms in the system.

Also, when a unit is displayed (i.e. Chiller page, see Paragraph 3.4.1), by pressing the triangle that appears on the machine, you go to a menu where you can see the current alarms of the selected machine.

### 4.8.2 ALARM HISTORY

The keyboard manages a detected alarms list for all the plant that shows the date and time of the alarm, the affected machine and alarm type. The alarm history stores up to 100 alarms; once this limit is exceeded, it automatically deletes the older alarms.

To go to the alarm history: from the system main page, go into "Configuration" -> "Service menu" -> "Alarm log".

Having the service password, you can set that the alarm history is also accessible from the user menu; to do this go into "Configuration" -> "Service menu" -> "Parameters" -> "Keyboard" -> **Par 33/65: Enable user alarm log = 1.**

## 4.9 DOUBLE SET-POINT FUNCTIONS

The double set-point function introduces a second plant side set-point (both in cooling mode and in heating mode).

The application field is primarily that of the floor-cooling assisted by fan coil units for dehumidification.

The purpose of the application is to prevent the formation of condensation on the floor in any condition, and in any case to ensure thermo hygrometric well-being.

The double set-point is activated from service parameter (from System main page -> Configuration -> Service menu -> Parameters -> Chiller -> Chiller name -> **H129: Enable second setpoint ≥ 2**, ref. the control manuals of the chiller unit for allowable values). It is also required to set a digital output for controlling the three-way valve used to divert the flow of water between the floor and fan coils. The humidistat function is instead carried out directly by the Hi-T2 remote control panel, by means of its integrated probes and the logic internally implemented related to the control of dew point and dehumidification.

Please refer to the manual of the chiller for the correct setting of parameters related to the double set-point, as well as for the electrical connections to be done in the terminal board of the chiller.

The set-points that can be set with double set-point function enabled are:

Setpoint	Setpoint at Hi-T2	Setpoint onboard control panel
First setpoint (°C)	T water	Coo/Hea
First setpoint eco (°C)	T Water ECO	
Second setpoint (°C)	T2 water	Co2/He2
Second setpoint eco (°C)	T2 water ECO	

Table 4. Set point settings with double set point enabled.

To manage the setpoint:

- from the Hi-T2 controller → "Set-point setup" menu -> "Chiller" -> "Summer" or "Winter" (see Paragraph 4.6.3).
- from the on-board control panel → SET button.

The second setpoint is higher than the first set point in summer and lower in winter:

- in summer:  $T_2 \geq T$
- in winter:  $T_2 \leq T$

The parameters to be set for the management of dehumidification are accessible from the service menu (*Configuration -> Service menu -> Parameters -> Keyboard*):

Parameter	Name	Unit	Default	Min.	Max.
Par 42/65	Dew-point temp. margin	°C	5.0	0.0	50.0
Par 43/65	Min. time in dehumidification	Seconds	300	0	600
Par 44/65	Max. time in dehumidification	Seconds	600	0	1200

Table 5. Service keyboard parameters for dehumidification.

**Note 1: set the lower limit of the first winter setpoint at 25°C**

- set the parameter **H129** = 3 or 4.
- Set the secondary winter setpoint from 35°C to 25°C
- Reset the parameter **H129** at 0
- You may now lower the winter setpoint to 25°C.

**Note 2:** if the presence of a digital input for management of the second set point is configured on the chiller (chiller parameter **H44=26**, output to second setpoint terminals, see Chiller manual), the humidity control is not managed from the remote control. The digital input is also possibly used for switching between the first and second set point during operation in winter mode.

With double set-point function enabled, if the chiller controls the temperature on the second set-point (radiant panels side), the double set-point icon displayed in the toolbar of the functions in the chillers and fan coils pages remains transparent. Whereas if the chiller controls the temperature on the first setpoint (fan coil side), the double setpoint icon will be coloured. Likewise entering into dehumidification is indicated in the chiller and fan coil toolbar by the icon switching from transparent to coloured.

Parameter **H129>1**, means:





	FLOOR SIDE FUNCTION (2nd SET-POINT)	FAN COIL SIDE OPERATION (1st SET-POINT)
DOUBLE SET-POINT ICON		
DEHUMIDIFICATION ICON		 if dehumidification is active

Table 6. Double set-point/dehumidification icons.

**4.9.1 DEW POINT CONTROL**

The dew point temperature will be calculated by reading the internal temperature and humidity probes.

Given the room temperature and room humidity, the controller calculates the dew point temperature (Td).

The formula used to calculate the dewpoint temperature is the Magnus – Tetens approximation. This approximation applies for dewpoint temperatures between 0°C and 50°C. Therefore, if the calculation gives a value outside of these limits, the limit value is assumed as the dewpoint temperature (respectively 0°C and 50°C).

Meaning of parameters:

- Tint: room temperature detected by the indoor temperature probe (°C)
- Tr: calculated temperature of the dew point (°C)
- odr: adjustment offset (°C)
- Hy: adjustment hysteresis (°C)
- tAr: adjustment time (min.)
- Relay activation time: 0-100% of tAr

The room temperature measured by the probe inside the controller will be compared with the dew point (evaluated at the last moment of tAr) added to the parameters odr and Hy:

- if  $Tr < Tint < Tr + odr \rightarrow$  Double setpoint active valve output
- if  $Tr + odr < Tint < Tr + odr + Hy \rightarrow$  Double setpoint active valve output for the value in % of tAr identified on the ramp
- if  $Tint > Tr + odr + Hy$  Double setpoint deactivated valve output for all the subsequent tAr time

The parameters tAr, odr and Hy are set in the factory and cannot be changed.

Given the environmental temperature and humidity, the Hi-T2 remote control calculates the dew point.

With plant operating in summer mode, with a double setpoint function active on chillers and temperature control normally performed with radiant panels (second work setting), a controller is activated to maintain the dewpoint temperature at least at an amount defined by the keyboard service parameter **Par42: "Dew-point temp. margin "** °C below the ambient temperature detected by the controller itself.

Instead, when  $Ambient\ temperature < Dew\ Point + Dew\ temp.\ margin$  :

- The fan coils for dehumidification turn on.
- The chillers start working with the set-point for the fan coils.

The permanence remains in this status until the temperature returns to:

$$Ambient\ temperature \geq Dew\ point + Dew\ temp.\ margin + 1^{\circ}C.$$

Even in the case where the above condition is verified, it remains in the dehumidification status for at least the time set by report service parameter **Par43**: "*Min. time in dehumidification*", in order to avoid annoying oscillations.

If the above condition is not met after a maximum time given by the keyboard service parameter **Par44**: "*Max Dehumidification time*", the machine comes out from dehumidification. To avoid returning immediately, in this case it requires remaining a minimum in adjustment on the radiant panels, still given by **Par43**: "*Max. time in dehumidification*".

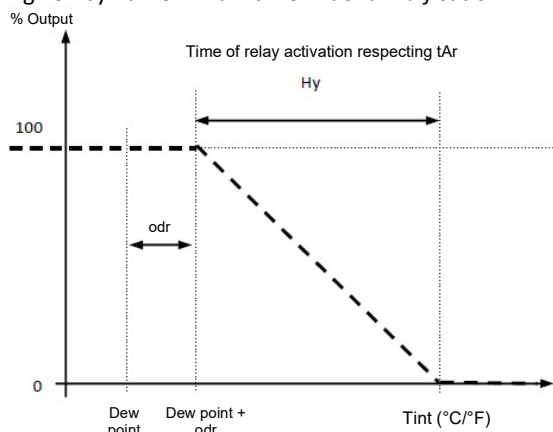

Figure 33: Dew point - Humidistat

#### 4.10 CLIMATIC COMPENSATION

It is possible to compensate the regulation set-points according to outdoor temperature, in a different way between heating and cooling modes, first and second set-point.

If you need to enable this function from Hi-T2 control panel, please be sure that, the dynamic setpoint parameter "**b08**" is disabled (=0) on the chillers (System's main page -> Configuration -> Service (maintenance) menu -> Parameters -> Chiller -> Chiller's name -> **b08**).

The parameters to be set from Hi-T2 control panel can be reached from the configuration page -> service (maintenance) menu -> Parameters -> Keyboard:

Number	Parameter name	Description	Range
11/65	Set Text comp CHIL Cool	Setpoint of external temp. for climatic compensation of the chiller in cooling	0 : 50°C
12/65	Set Text comp CHIL Heat	Setpoint of external temp. For climatic compensation of the chiller in heating	-20 : 35°C
13/65	m1 comp Text CHIL	Angular coefficient of the chiller compensation line (cooling)	-10 : 10
14/65	m2 comp Text CHIL	Angular coefficient of the chiller compensation line (cooling)	-10 : 10
15/65	m3 comp Text CHIL	Angular coefficient of the chiller compensation line (heating)	-10 : 10
16/65	m4 comp Text CHIL	Angular coefficient of the chiller compensation line (heating)	-10 : 10
17/65	Set Text comp FC Cool	External temp. Setpoint for the climatic compensation of the zone in cooling	0 : 50°C
18/65	Set Text comp FC Heat	External temp. Setpoint for the climatic compensation of the zone in heating	-20 : 35°C
19/65	m5 comp Text CHIL	Angular coefficient of the of the compensation line of the zones (cooling)	-10 : 10
20/65	m6 comp Text CHIL	Angular coefficient of the of the compensation line of the zones (heating)	-10 : 10
21/65	Set2 Text comp CHIL Cool	External temp. Setpoint for the climatic compensation of the second setpoint of the	0 : 50°C

		chiller in cooling mode	
<b>22/65</b>	Set2 Text comp CHIL Heat	External temp. Setpoint for the climatic compensation of the second setpoint of the chiller in heating mode	-20 : 35°C
<b>23/65</b>	Second m1 comp Text CHIL	Angular coefficient of the compensation line of the second setpoint of the chiller (cooling)	-10 : 10
<b>24/65</b>	Second m2 comp Text CHIL	Angular coefficient of the compensation line of the second setpoint of the chiller (cooling)	-10 : 10
<b>25/65</b>	Second m3 comp Text CHIL	Angular coefficient of the compensation line of the second setpoint of the chiller (heating)	-10 : 10
<b>26/65</b>	Second m4 comp Text CHIL	Angular coefficient of the compensation line of the second setpoint of the chiller (heating)	-10 : 10



• **CHILLER'S CLIMATIC COMPENSATION**

By setting the coefficients  $m_1$ ,  $m_2$ ,  $m_3$ ,  $m_4$  (parameters 13, 14, 15, 16) to a non-zero value, the "Offset" item appears on the "Set -> Chiller" menu.

$m_1$  and  $m_2$  are the cooling operation coefficients:  $m_1$  sets the slope for values lower than ( $Set T_{ext}$ ) the external temp. setpoint (see the curve), while  $m_2$  sets the slope to the right side of this value. Similarly  $m_3$  and  $m_4$  are the angular coefficients for heating. Offset describes the expected maximum variation of the water setpoint. It can be set from 0 to 3.



Figura 34. Chiller's climatic compensation

In order to exclude the climatic compensation changes by the user, the offsets must be set to zero from the setting "Set" -> "Chiller" menu.

To exclude the climatic compensation changes by the maintenance technician, the coefficients "m" must be set to zero from the service (maintenance) technician menu, keyboard parameters.

**Example 1:** Heating with compensation only for outside temperatures below  $Set T_{ext}$

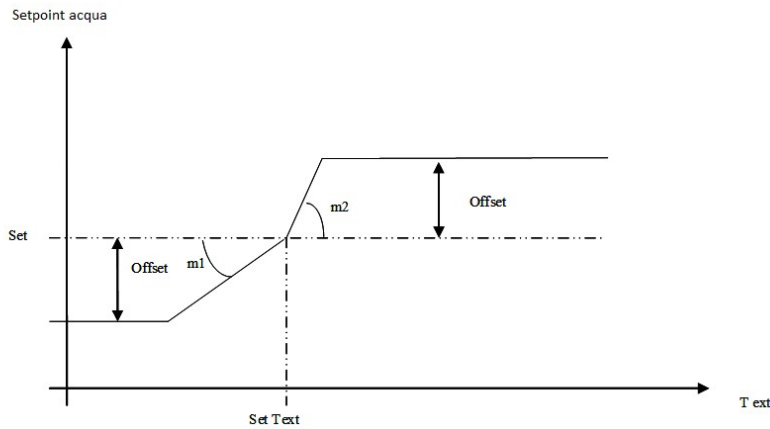
Set initial winter set point	30,00
Set initial outdoor temperature related to initial winter set point	0,00
Set final winter set point	35,00
Set final outdoor temperature related to final winter set point	-5,00

**PARAMETERS AND VALUES TO SET CONTROL**

PAR12: set Text comp CHIL Heat =	0,00
PAR15: m3 comp Text CHIL =	-1,00
PAR16: m4 comp Text CHIL =	0,00
Offset (heating setpoint menu, max 10 ° C) =	5,00
Water set (heating setpoint menu) =	30,00

**Example**

Set outdoor temperature	5
Output set-point value	30,00

The 'Heat Pump' graph shows 'SET POINT' on the y-axis (ranging from 29,00 to 36,00) and 'OUTDOOR TEMPERATURE' on the x-axis (ranging from -10,00 to 4,00). The curve is horizontal at 35,00 for outdoor temperatures between -8,00 and -4,00. Below -8,00, the curve slopes downwards with a slope of  $m_3 = -1,00$ . Above 0,00, the curve is horizontal at 30,00. The vertical distance between the 35,00 and 30,00 levels is the 'Offset' of 5,00.

**Example 2:** Cooling with compensation only for external temperatures above the  $Set T_{ext}$

Set initial summer set point	11,00
Set initial outdoor temperature related to initial summer set point	21,00
Set final summer set point	7,00
Set final outdoor temperature related to final summer set point	35,00

**PARAMETERS AND VALUES TO SET CONTROL**

PAR11: set Text comp CHIL Cool =	21,00
PAR13: m1 comp Text CHIL =	0,00
PAR14: m2 comp Text CHIL =	-0,29
Offset (cooling setpoint menu, max 10 ° C) =	14,00
Water set (cooling setpoint menu) =	11,00

**Example**

Set outdoor temperature	10
Output set-point value	11,00

The 'Chiller' graph shows 'SET POINT' on the y-axis (ranging from 0,00 to 12,00) and 'OUTDOOR TEMPERATURE' on the x-axis (ranging from 10,00 to 40,00). The curve is horizontal at 11,00 for outdoor temperatures between 10,00 and 21,00. Above 21,00, the curve slopes downwards with a slope of  $m_2 = -0,29$ . Below 35,00, the curve is horizontal at 7,00. The vertical distance between the 11,00 and 7,00 levels is the 'Offset' of 4,00.

• **ZONE'S CLIMATIC COMPENSATION**

It is used to compensate the zones' temperature, always with respect to the external air temperature.

By setting the coefficients m5, m6 (parameters 19, 20) to a non-zero value, the "Offset" item appears on the "Settings" -> "Zone 1" menu.

m5 and m6 are the angular coefficients, by setting them to a non-zero value, the "Offset" item appears on the "Settings" -> "Zone 1" menu, which describes the expected maximum variation of the water setpoint. The operation is the same as in chiller mode, excepting that the compensation is related to the temperature detected by the air temperature sensor of the Hi-Tcontrol panel (zone 1) or of the fan coil (zone n).

m5 = angular coefficient for the slope of the compensation in cooling mode.

m6 = angular coefficient for the slope of the compensation in heating mode.

In cooling mode, the external reference temperature is the parameter 17 ("Settings -> Service menu -> Parameters -> Keyboard -> Set Text comp FC Cool").

In heating mode, the reference external temperature is the parameter 18 ("Settings -> Service menu -> Parameters -> Keyboard -> Set Text comp FC Heat").

To exclude the climatic compensation changes by the user, the offsets must be set to be zero from the "Settings -> Zone" menu.

To exclude the climatic compensation changes by the maintenance technician, the coefficients "m" must be set to be zero from the service menu, keyboard parameters.

**4.11 OTHER FUNCTIONS**

For any information related to other functions of the chillers or fan coil units that are reported in the display of Hi-T2 remote control panel (e.g. enabling or activation of plant electrical heater, DHW integration heater, boiler integration, defrosting cycle, water-side or air-side anti-freeze heaters, etc...), please refer to chiller and fan coil instruction manuals.

**4.12 SPECIAL FUNCTIONS**

From the main menu, choosing the icon additional functions, you go to the following menu:



Figure 35. "Special functions" page.

The available functions are described in the following paragraphs.

**4.12.1 SCREED FUNCTION**

By pressing the icon related to the screed function you open a new menu in which you can choose which chillers should be enabled in this function:

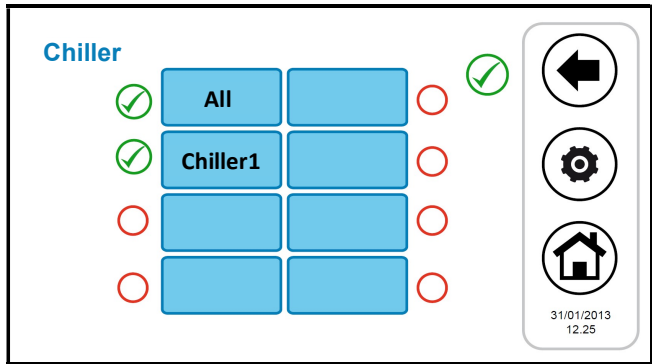

Figure 36. Chiller multiple choice, screed function.

Once you choose the chillers which participate in this regulation, the system has the following behaviour:

- All the chillers enabled in the screed function are forced to heating mode.
- All the chillers not enabled in the screed function are forced to OFF mode.

- The chillers set-point is given by the parameter *Screed* setting, which can be set among the service parameters (*Configuration -> Service menu -> Parameters > Keyboard -> Par 36/65: "Screed function setting"*).
- The function has a duration given by the service parameter (*Configuration -> Service menu -> Parameters > Keyboard -> Par 37/65: "Duration screed function"*). When this time has elapsed, system operation returns to the previous settings.

#### 4.13 PASSWORD AND PROTECTIONS

There are several protection and password levels.

An initial distinction entails the following 3 access levels:

- User level
- Service level
- Manufacturer level

You can access each these 3 different levels from the "Configuration" screen after entering the specific password.

The user password, by default set to "0", can be modified by accessing to user parameters (see Paragraph 3.6.5.1).

The service password can be modified by accessing to service parameters (see Paragraph 3.6.5.2).

The manufacturer password can be modified by accessing to manufacturer parameters (see Paragraph 3.6.5.3).

Once the password has been entered, you may completely navigate all the pages where access is allowed.

Once the navigation has terminated, log-out should be done by touching the related symbol flashing on the bottom right of the Home page.



You logout automatically after 5 minutes of touch-screen inactivity or after 20 minutes from accessing the current level of protection. These timing values can be modified from service or manufacturer parameter.

There is a password to unlock the screensaver, set by default to "0" and modifiable by accessing the user parameters (see Paragraph 3.6.5.1).

## 5 FIRMWARE UPDATE

By pressing the symbol at the top right of the home page showing Hi-T2, it is possible to see the current firmware version installed in the touch-screen.



In case of firmware update, it is possible to make the upgrade by means of a USB key, using the on-board USB port.

For the upgrade:

- copy the upgrade files in the root directory of a USB pen-drive;
- insert the pen-drive into the Hi-T2 USB port;
- enter into "*Configurations -> "User menu"*" (see Paragraph 3.6.5.1);
- after having entered the user password and entered the "*User menu"*", select the string which appears: "*Firmware update"*";
- the controller automatically recognises the firmware presence inside the USB pen-drive and starts the updating procedure;
- follow the instructions shown on the display and extract the pen-drive only when requested by the message "*Remove the USB pen-drive. The panel will reboot to finish the update"*";
- wait until the update has completed.

## 6 Hi-T2 CONFIGURATION PARAMETERS

The service parameters of the Chillers are those shown in the user-installer manual of I-32V5 chiller/heat pump units.

The service parameters of the keyboard are shown in the following table:

N.	PARAMETER NAME	MINIMUM VALUE	MAXIMUM VALUE	VALUE DEFAULT	UNIT OF MEASUREMENT
1	Temperature communication timeout	1	255	120	Seconds
2	Service PSW	0	999	/	---
3	Min setpoint cooling FC	1.0	60.0	15.0	°C
4	Max setpoint cooling FC	1.0	60.0	45.0	°C
5	Min setpoint heating FC	1.0	60.0	5.0	°C

6	Max setpoint heating FC	1.0	60.0	45.0	°C
7	Keypad address	100	130	100	---
8	Number of chillers in network	0	7	0	---
9	Rotation time	0	800	1	hours
10	Differential between units	1.0	60.0	2.0	°C
11	Set Text comp CHIL Cool	0.0	50.0	20.0	°C
12	Set Text comp CHIL Heat	-20.0	35.0	10.0	°C
13	m1 comp Text CHIL	-10.0	10.0	0.0	---
14	m2 comp Text CHIL	-10.0	10.0	0.0	---
15	m3 comp Text CHIL	-10.0	10.0	0.0	---
16	m4 comp Text CHIL	-10.0	10.0	0.0	---
17	Set Text comp FC Cool	0.0	50.0	25.0	°C
18	Set Text comp FC Heat	-20.0	35.0	15.0	°C
19	m5 comp Text FC	-10.0	10.0	0.0	---
20	m6 comp Text FC	-10.0	10.0	0.0	---
21	Set2 Text cmp CHIL Cool	0.0	50.0	20.0	°C
22	Set2 Text cmp CHIL Heat	-20.0	35.0	10.0	°C
23	Second m1 cmp Text CHIL	-10.0	10.0	0.0	---
24	Second m2 cmp Text CHIL	-10.0	10.0	0.0	---
25	Second m3 cmp Text CHIL	-10.0	10.0	0.0	---
26	Second m4 cmp Text CHIL	-10.0	10.0	0.0	---
27	ID on 15-16	0	1	0	---
28	Enables Beep touch	0	1	1	---
29	Service Psw Timeout	0	120	5	Minutes
30	Service Psw exit time	0	120	20	Minutes
31	Legionella disinfection duration	10	600	60	Minutes
32	User password	0	999	0	---
33	Enables user alarm log	0	1	0	---
34	Idle backlight intensity	0	100	5	%
35	Screensaver unlock Psw	0	999	0	---
36	Screed function setting	0.0	55.0	35.0	°C
37	Screed function duration	0	100	10	Hours
38	Timeout LCD navigation	30	300	60	Seconds
39	Thermostat temp. decalibration	-10.0	10.0	0.0	°C
40	Thermostat humidity probe decalibration	-10.0	10.0	0.0	%
41	Bitmap forcing icons	0	4095	0	---
42	Dew-point temp. margin	0.0	50.0	5.0	°C
43	Min. time in dehumidification	0	600	300	Seconds
44	Max. time in dehumidification	0	1200	600	Seconds
45	Chiller system offline behaviour for adjustment of only pump in network	0	1	0	Flag

46	Regulation temperature in zone 1 winter 0 = Average temp. of the fan coils of the zone 1 = Minimum temp. of the fan coils of the zone 2 = Maximum temp. of the fan coils of the zone 3 = Temperature measured by Hi-T2	0	3	3	---
47	Regulation temperature in zone 2 winter 0 = Average temp. of the fan coils of the zone 1 = Minimum temp. of the fan coils of the zone 2 = Maximum temp. of the fan coils of the zone 3 = Temperature measured by Hi-T2	0	3	1	---
48	Regulation temperature in zone 3 winter 0 = Average temp. of the fan coils of the zone 1 = Minimum temp. of the fan coils of the zone 2 = Maximum temp. of the fan coils of the zone 3 = Temperature measured by Hi-T2	0	3	1	---
49	Regulation temperature in zone 4 winter 0 = Average temp. of the fan coils of the zone 1 = Minimum temp. of the fan coils of the zone 2 = Maximum temp. of the fan coils of the zone 3 = Temperature measured by Hi-T2	0	3	1	---
50	Regulation temperature in zone 5 winter 0 = Average temp. of the fan coils of the zone 1 = Minimum temp. of the fan coils of the zone 2 = Maximum temp. of the fan coils of the zone 3 = Temperature measured by Hi-T2	0	3	1	---
51	Regulation temperature in zone 6 winter 0 = Average temp. of the fan coils of the zone 1 = Minimum temp. of the fan coils of the zone 2 = Maximum temp. of the fan coils of the zone 3 = Temperature measured by Hi-T2	0	3	1	---
52	Regulation temperature in zone 7 winter 0 = Average temp. of the fan coils of the zone 1 = Minimum temp. of the fan coils of the zone 2 = Maximum temp. of the fan coils of the zone 3 = Temperature measured by Hi-T2	0	3	1	---
53	Regulation temperature in zone 8 winter 0 = Average temp. of the fan coils of the zone 1 = Minimum temp. of the fan coils of the zone 2 = Maximum temp. of the fan coils of the zone 3 = Temperature measured by Hi-T2	0	3	1	---
54	Regulation temperature in zone 9 winter 0 = Average temp. of the fan coils of the zone 1 = Minimum temp. of the fan coils of the zone 2 = Maximum temp. of the fan coils of the zone 3 = Temperature measured by Hi-T2	0	3	1	---
55	Regulation temperature in zone 1 summer 0 = Average temp. of the fan coils of the zone 1 = Minimum temp. of the fan coils of the zone 2 = Maximum temp. of the fan coils of the zone	0	3	3	---

	3 = Temperature measured by Hi-T2				
56	Regulation temperature in zone 2 summer 0 = Average temp. of the fan coils of the zone 1 = Minimum temp. of the fan coils of the zone 2 = Maximum temp. of the fan coils of the zone 3 = Temperature measured by Hi-T2	0	3	1	---
57	Regulation temperature in zone 3 summer 0 = Average temp. of the fan coils of the zone 1 = Minimum temp. of the fan coils of the zone 2 = Maximum temp. of the fan coils of the zone 3 = Temperature measured by Hi-T2	0	3	1	---
58	Regulation temperature in zone 4 summer 0 = Average temp. of the fan coils of the zone 1 = Minimum temp. of the fan coils of the zone 2 = Maximum temp. of the fan coils of the zone 3 = Temperature measured by Hi-T2	0	3	1	---
59	Regulation temperature in zone 5 summer 0 = Average temp. of the fan coils of the zone 1 = Minimum temp. of the fan coils of the zone 2 = Maximum temp. of the fan coils of the zone 3 = Temperature measured by Hi-T2	0	3	1	---
60	Regulation temperature in zone 6 summer 0 = Average temp. of the fan coils of the zone 1 = Minimum temp. of the fan coils of the zone 2 = Maximum temp. of the fan coils of the zone 3 = Temperature measured by Hi-T2	0	3	1	---
61	Regulation temperature in zone 7 summer 0 = Average temp. of the fan coils of the zone 1 = Minimum temp. of the fan coils of the zone 2 = Maximum temp. of the fan coils of the zone 3 = Temperature measured by Hi-T2	0	3	1	---
62	Regulation temperature in zone 8 summer 0 = Average temp. of the fan coils of the zone 1 = Minimum temp. of the fan coils of the zone 2 = Maximum temp. of the fan coils of the zone 3 = Temperature measured by Hi-T2	0	3	1	---
63	Regulation temperature in zone 9 summer 0 = Average temp. of the fan coils of the zone 1 = Minimum temp. of the fan coils of the zone 2 = Maximum temp. of the fan coils of the zone 3 = Temperature measured by Hi-T2	0	3	1	---
64	Polling duration	0.1	1.0	0.1	Seconds
65	Port for web server	0	9999	80	---

## 7 FAN COIL CONFIGURATION PARAMETERS

**NB: Please make reference to the manual of RFC controls for more details about the parameterization and the operation of the product. (MCO01137I0300).**

The service parameters of the fan coil units which can be modified by Hi-T2 control panel are described in the following table:

N.	PARAMETER NAME	MINIMUM VALUE	MAXIMUM VALUE	VALUE DEFAULT	UNIT OF MEASUREMENT
1	Setpoint limits  5 = Relative setpoint 0°C 6 = Relative setpoint +/-1°C 7 = Relative setpoint +/-2°C 8 = Relative setpoint +/-3°C 9 = Relative setpoint +/-4°C 10 = Relative setpoint +/-5°C	5	10	5	---
2	Neutral band  0 = Neutral band 4.0°C 1 = Neutral band 3.0°C 2 = Neutral band 2.0°C 3 = Neutral band 1.0°C 4 = Neutral band 0°C	0	4	2	---
3	Plant type  0 = 2-PIPE plant 1 = 4-PIPE plant	0	1	0	---
4	Fan mode  0 = CONTINUOUS FAN 1 = FAN ALWAYS THERMOSTAT CONTROLLED 2 = CONTINUOUS FAN ONLY IN SUMMER 3 = CONTINUOUS FAN ONLY IN WINTER	0	3	0	---
5	Actuator type  0 = ON-OFF ACTUATOR	0	0	0	---
6	Window contact type  0 = ACTIVE IN CLOSING 1 = ACTIVE IN OPENING	0	1	0	---
7	Reduction of eco setting  0 = 2°C 1 = 4 °C 2 = 6 °C 3 = 8 °C 4 = 10 °C	0	4	2	---
8	Water temperature probe function 2 = Fan consent in winter 3 = Water temperature probe not present	2	3	2	---
10	Temperature Offset 0 = Offset 0.0 °C 1 = Offset + 1.0 °C 2 = Offset - 1.0 °C 3 = Offset + 2.0 °C 4 = Offset - 2.0 °C	0	4	0	---
11	Primary electric heater fan motor speed  Sets the fan speed motor 0-10V with primary electric heater	0.0	10.0	5.0	V

12	Winter temperature consent  Sets the threshold above which winter season is considered (Water outlet temperature)	0.0	50.0	35.0	°C
13	Summer temperature consent  Sets the threshold above which summer season is considered (Water outlet temperature)	0.0	25.0	25.0	°C
14	Antifreeze setting Winter antifreeze temperature	0.0	10.0	4.0	°C
15	Auxiliary output deviation Sets the temperature difference value with respect to the setpoint for auxiliary output activation	0.0	10.0	0.5	°C
17	Destratification time off	0	60	15	min
18	Destratification time on	0	10	0	min
19	Fan activation delay in winter after hot valve	0	250	60	sec
20	Fan activation delay in winter with respect to activation of primary heater output.	0	250	60	sec
21	Post-ventilation Fan deactivation delay in Winter operation when the primary electric heater is deactivated	0	250	60	sec
22	Fan motor control mode 1 = Remote function from master with possible action by user 2 = Absolute function only by Master 3 = funzionalità as 1 if the Zone is ON, otherwise constrained OFF	1	3	2	---
23	Fan coil ID offset Extends the possibility of having network addresses > 22 elements  Address = (Par23 * 32) + Dip-Switch value You need to restart the RFC control in order to use the new address	0	2	0	---

To change the value of a parameter:

- having entered the parameter list of the chiller, fan coil or keyboard, use the up and down arrow keys to scroll through the pages of the parameters, up to the desired parameter;
- press on the currently set value;
- the current value turns red to indicate that it can be changed by using the up and down arrows;
- select the desired value and press the confirmation tick .

**Note:** after selecting the desired value, if you miss the confirmation tick, the previous setting value will be kept.

To copy the value of a parameter to all fan coils:

By pressing the "COPY"  near the set value, this last one will be copied automatically to all present fan coils.

## 8 DESCRIPTION OF RFC SYSTEM

First of all refer to the specific RFC manual (MCO01137I0300 FAN COIL REGULATOR).

The RFC system can be installed with the hydronic terminals of the VE, HCN and HCNA series.

There are two ways to install the RFC control system:

- 1) Installation inside fan coil compartment
- 2) Wall installation using screws

In the standard configuration, the Hi-T2 control panel allows a complete control of the fan coil units; however with a switchable configuration of the RFC control system, you can get access to some manual features for comfort adjustment. In fact, it is possible to adjust the setpoint using the main knob giving a slight variation of the setpoint value (up to +/-5°C) that is already set by the Hi-T2 control panel. Moreover, with appropriate parameterization, you can allow the RFC control system to operate manually on ventilation; particularly, it is possible to establish whether to keep the automatic regulation made by the Hi-T2 control panel, or to use the appropriate knob whether to stop or set one of the 3 fan speeds.



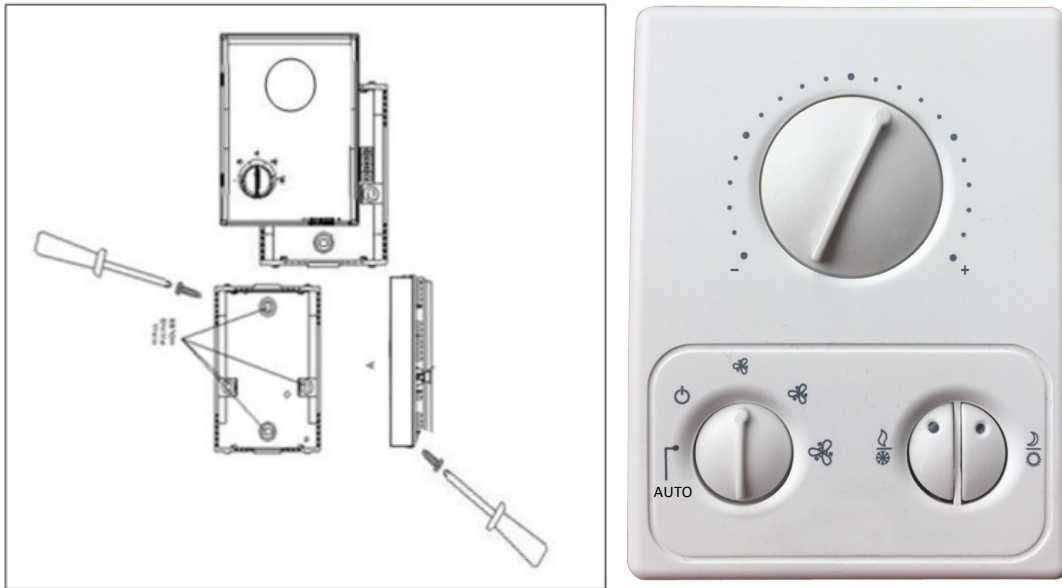

The “Hi-T2” remote control panel allows you to view the working parameters of each individual water terminal unit and those of each individual zone.

It is possible to manage up to 80 water terminal units which can be divided into 9 thermal zones. Each water terminal unit, once it receives the relative setting of the zone it belongs to, uses the proper temperature probe as a working probe.

When installing the RFC system with our I-32V5 chillers, it is possible to manage with a single Hi-T2 remote control panel up to 7 chillers/heat pumps in cascade and up to 80 terminal units divided into 9 thermal zones. The connection between the Hi-T2 remote control panel, chillers and water terminal units is very simple: it requires a shielded twisted pair cable SFTP (e.g. CAT5) connected in series.

Possible configurations:

- 1 chiller/heat pump without water terminal units connected
- up to 7 chillers/heat pumps in cascade without water terminal units connected
- 1 chiller/heat pump with connected terminal units (up to 80 units)
- up to 7 chillers/heat pumps with connected terminal units (up to 80 units)

The chillers/heat pumps which shall be connected in cascade do not require additional work probes to place in the total system outlet pipe since the centralized system acquires the individual temperatures of each unit and controls the average flow temperature. The advantage of a combined RFC system lies in the fact that the only interface for the user is the Hi-T2 touch-screen remote control which is an easy and user-friendly interface for setting and monitoring the "water terminal units + chiller/heat pumps" system. It is also possible to connect in cascade chillers/heat pumps of different output capacities; the Hi-T remote control panel can determine the installed output. From the remote control display, you can also know the number of the operating water terminal units respect to those installed and the number of active chillers in the network compared to the installed ones.

## 9 CONNECTION NETWORK

The connection network is based on the RS-485 electrical standard and on the standard Modbus RTU protocol. The network consists of a "master unit", “Hi-T2” remote control panel, and a variable number of "slaves". The chillers/heat pumps with addresses from 1 to 7 are considered as "slaves". The RFCs with addresses from 10 to 96 are "slaves" (actually up to a maximum of 80 fan coils can be configured).

Here are some important notes for the network’s electrical connection:

1. Use an adequate cable for RS-485 standard (twisted and shielded). It is also possible to use common CAT.5 UTP cables, but the effect is to reduce the maximum network length in half.
2. Connect the bus in a daisy-chain fashion (enter/exit type), as shown in the figure. It is considered bad practice to create branches that connect devices with the main backbone of the bus, though they are allowed if they do not exceed 2m long.
3. In the most classic installation, a "baudrate" of 9600bps is used; in this configuration the maximum network length is about 1000m.
4. Connect 120Ω termination resistors at the beginning of the bus (Hi-T) and at the end (last "slave"). The heater on Hi-T2 is already present on the hardware; just bring the dip switch over the 3-4 connectors to the ON position. On the "slave" insert a physical resistor between the 2 poles (R + / R- for the chillers, A/B for the RFC modules).
5. Respect a minimum length of 1 meter between the devices in the bus.
6. Do not connect the GNDR to earth

