



INSTALLATION AND SERVICING

ECOMOD HEAT PUMP CONTROL

Hot water preheating with gaz complement

When replacing any part on this appliance, use only spare parts that you can be assured conform to the safety and performance specification that we require. Do not use reconditioned or copy parts that have not been clearly authorised by Ideal.

For the very latest copy of literature for specification and maintenance practices visit our website www.idealcommercialboilers.com where you can download the relevant information in PDF format.



**DECLARATION DE CONFORMITE AUX NIVEAUX D EMIS-
SION NOX ET CO**

TABLE OF CONTENTS

1. WARNINGS AND COMPLIANCE	5
1.1. Unpacking and reservations	5
2. TECHNICAL SPECIFICATIONS	7
2.1. General	7
2.2. Dimensions	7
2.3. Delivered unit	8
2.4. Technical data	9
2.5. Basic equipment	9
3. INSTALLATION	11
3.1. Installation of the control panel	11
3.2. Installation of flow sensor in the tank or decoupling bottle	12
3.3. Electrical connection	13
4. USER INTERFACE	18
4.1. Presentation of the interface	18
4.2. Display	18
4.3. Fault display	20
4.4. Ecomod HMI browsing	21
4.6. Settings	23
5. OPERATING CYCLES	24
5.1. Heat Pump start-up	24
5.2. Heat pump shutdown:	24
5.3. Cascade cycles	24
6. DIAGNOSTIC HELP	25
7. LIST OF PARAMETERS	28
8. PARAMETERS	30
8.1. "User interface" parameters	30
8.2. "DOMESTIC HOT WATER (DHW)" PARAMETERS	34
8.3. "Heat pump" parameters	35
8.4. "DHW TANK" parameters	35
8.5. "Configuration" settings	37
8.6. "LPB system" parameters	42
8.7. "Error" parameters	44
8.8. "Maintenance/Special operation" parameters	45
8.9. "Inputs/outputs test" parameters	47
8.10. "Status" parameters	49
8.11. "Diagnostics" parameters	51

9. HYDRAULIC DIAGRAMS AND CONFIGURATIONS	53
9.1. Symbols used in the diagrams	53
9.2. List of diagrams	54
10. ELECTRICAL VALIDATION	77
12. SPARE PARTS LIST	78
11. LACK OF WATER SAFETY FUNCTION	78
13. ADDITIONAL ACCESSORIES	80
13.1. Temperature sensors	80

1. WARNINGS AND COMPLIANCE

1.1. Unpacking and reservations

With the carrier present, carefully check the general appearance of the packaging and of the control panel. If in doubt, do not use the appliance.

In the event of disagreement, write to the carrier within 48 hours mentioning all reserves and send a copy of this letter to the After Sales Department.

Storage

The control panel:

- must be arranged horizontally in a place where the temperature is between 0 °C and +45 °C
- must be protected from humidity.

Symbols used in this document



INFORMATION: This symbol draws attention to comments.



CAUTION: Failure to follow these instructions may cause damage to the installation or to other objects.



WARNING: Failure to comply with these instructions may cause injury and serious damage to property.



WARNING: Failure to comply with these instructions may cause electrocution.

Compliance with European Directives

Low voltage (2006/95/CE)

- This appliance complies with all requirements of current I.E.E (BS7671) Wiring Regulation.
- This appliance is not intended for use by persons (including children) whose physical, sensory or mental abilities are reduced, or persons without experience or knowledge, unless they have been able to benefit, through someone responsible for their safety, from supervision or prior instruction concerning the use of the appliance.
- Children must be supervised to ensure they do not play with the appliance.

Electromagnetic compatibility (2004/108/CEE)

- This appliance conforms with all requirements of the electromagnetic compatibility directive BS EN61000 - 6 - 1, BS EN61000 - 6 - 3.
- This is a class A appliance. In a residential environment, this appliance may cause radio-electric interference. In this case, the user may be asked to take appropriate measures.



Environmental compatibility

- This appliance contains electrical and electronic elements which must not be disposed of with household waste.
- Local legislation must be complied with.

Installation and maintenance rules

The control panel must be installed and maintained by an approved professional in accordance with the prevailing regulations and code of practice, particularly current I.E.E (BS7671) Wiring Regulations..



CAUTION:

Before opening the Ecomod Heat Pump Control regulator unit, make sure that no water is present on the top of the case.



CAUTION:

The control panel is classified as an appliance which is not accessible to the public (closed electrical operating zone).



CAUTION:

The control panel must only be used for the purpose for which it was designed; any other use must be considered inappropriate and therefore dangerous.



CAUTION:

The appliance must be sheltered from rain, snow and frost.



WARNING:

The regulation box and its components must not be exposed to a temperature higher than 45°C when it is in service.



INFORMATION:

This product must be assembled, used and maintained in compliance with the information provided in these technical instructions.



DANGER:

Always turn the control panel off before carrying out any work on it.



DANGER:

Always turn the control panel off before carrying out any work on the Ecomod Heat Pump Control, Ecomod or other heating elements (pumps, valves, etc.) controlled by the control panel.

2. TECHNICAL SPECIFICATIONS

2.1. General

The control panel is used to control the heat pump and the hydraulic station. In this way, it is possible to produce domestic hot water according to the Ecomod Heat Pump Control operating mode.

For further information on the operating logic, see chapter: 8.4.1 Load regulation*.

2.2. Dimensions

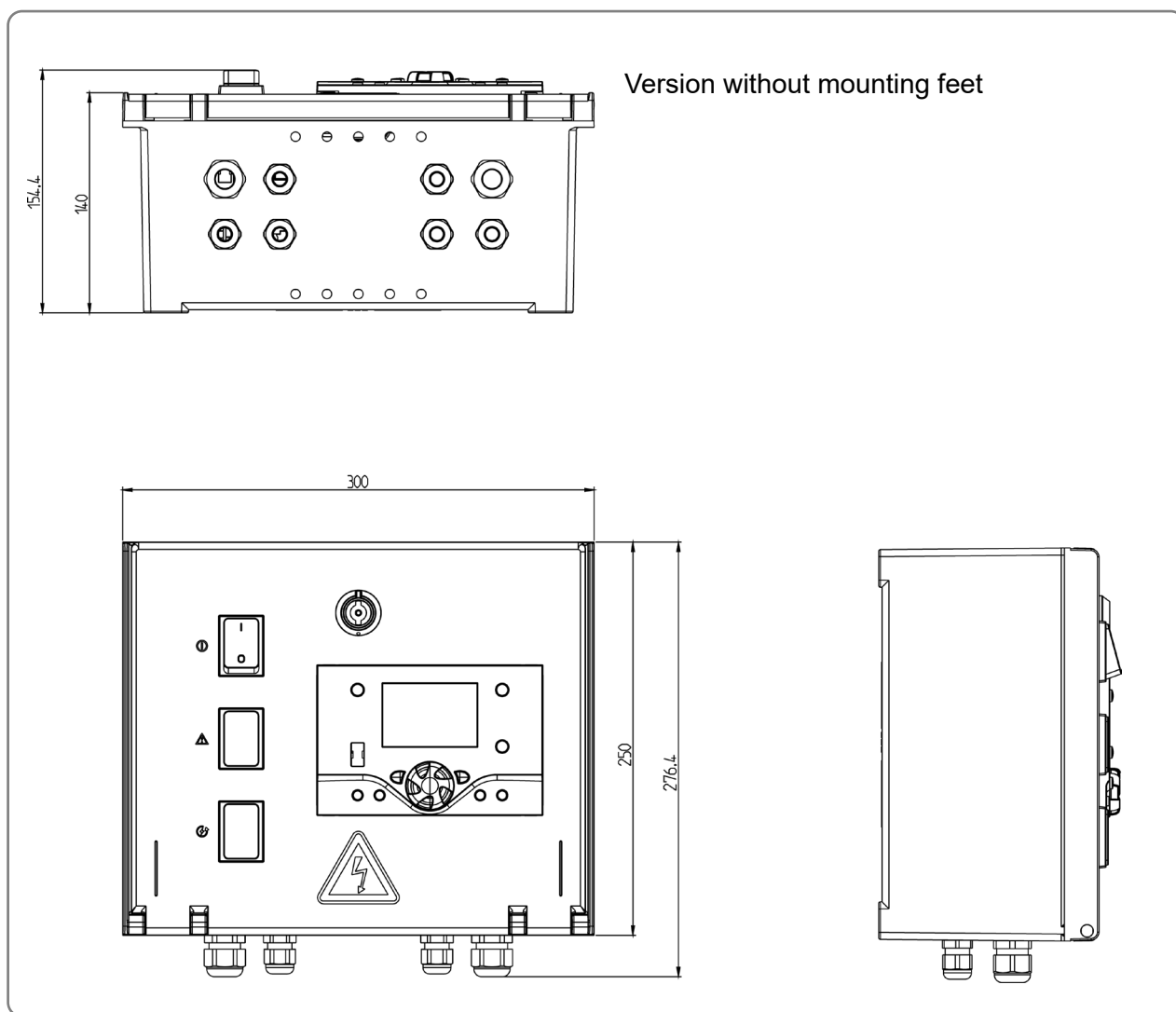
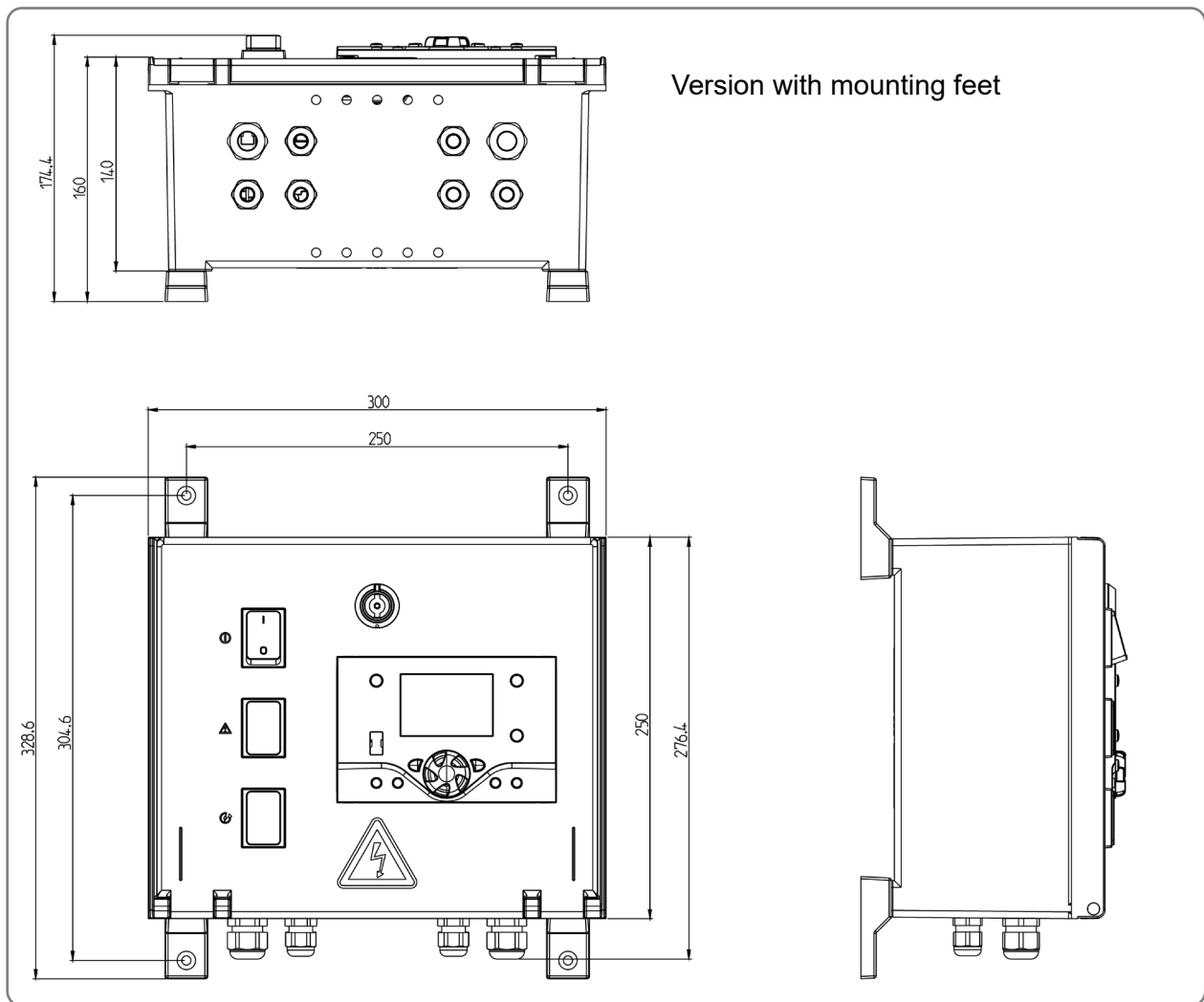

figure 1 - Dimensions (in mm)



Version with mounting feet

figure 2 - Dimensions (in mm)

2.3. Delivered unit

- Case
- Servicing, installation and maintenance instructions
- Wiring diagram
- Locking key
- Mounting kit (mounting feet + bolts)

2.4. Technical data

Name of manufacturer	IDEAL
Unique reference	Ecomod Heat Pump Control
Single-phase power supply	230 VAC 50Hz
Rated current	6 A
Casing protection index	IP21
Pollution level	Pollution level II
Protection index	Class I (surge voltage = 800 V)
Electrical consumption	On standby: 10W When in operation: Depends on appliances plugged in (pumps, mixing valves)
Relative humidity	<95%
Terminal output power	Voltage: 230V AC (+10%/-15%) Amperage: 2A max. per low voltage output
Type of printed circuit board(s) coating	EPOXY FR4 FT glass
Weight	3.4Kg

2.5. Basic equipment

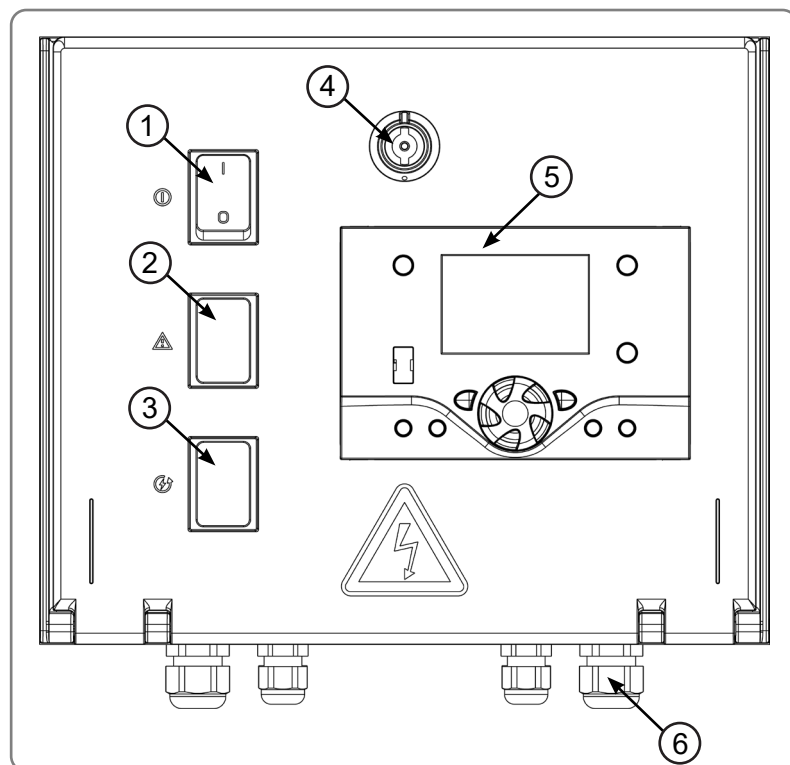

1. On switch
2. Fault light
3. Cover
4. Lock
5. Control panel display
6. Packing gland

figure 3 - Outside view

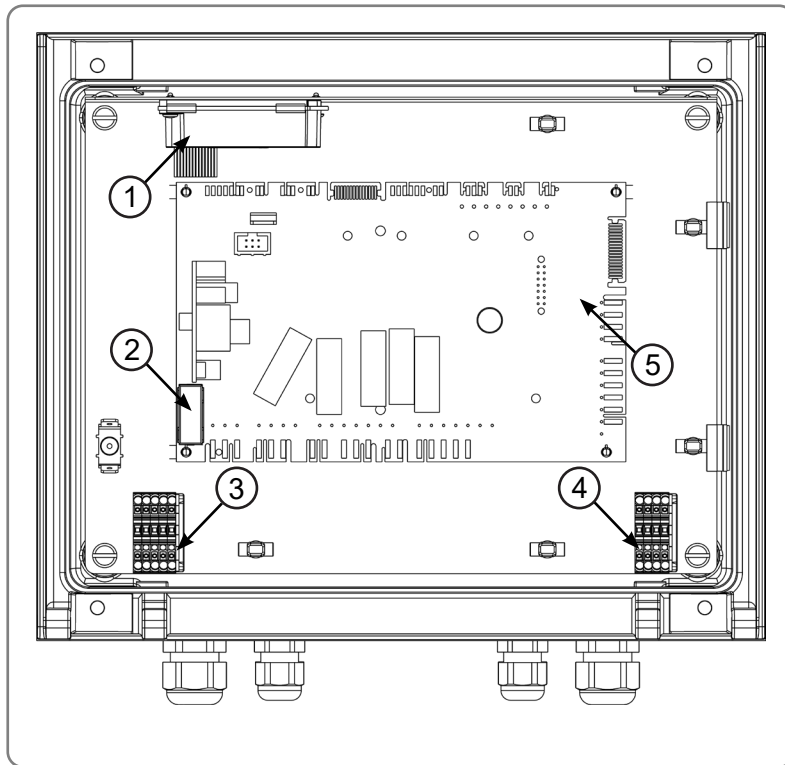

1. OCI 351
2. Fuse slot
3. Low voltage power supply terminal block
4. Very low voltage power supply terminal block
5. RVS 21 main circuit board

figure 4 - Inside view



CAUTION:

The RVS 21 regulator is protected with a 6.3 A fuse. The total load of the consuming elements connected to this regulator must not be more than 6.3 A.



INFORMATION:

The electrical connection diagrams (temperature sensors, etc.) are provided in accordance with the hydraulic configuration.



CAUTION:

The maximum amperage on each of the commanded outputs must not be more than 2 A. The regulation board relays cannot accept a higher load.

3. INSTALLATION

3.1. Installation of the control panel

3.1.1. Installation recommendations

The Ecomod Heat Pump Control control panel must be installed in a technical area. Avoid installing the regulating system under a water pipe.

The equipment is intended to be wall mounted, using screws and anchors supplied (to be adapted to suit the wall structure), at operator height to facilitate the use of the control panel display.

3.1.2. Version with mounting feet

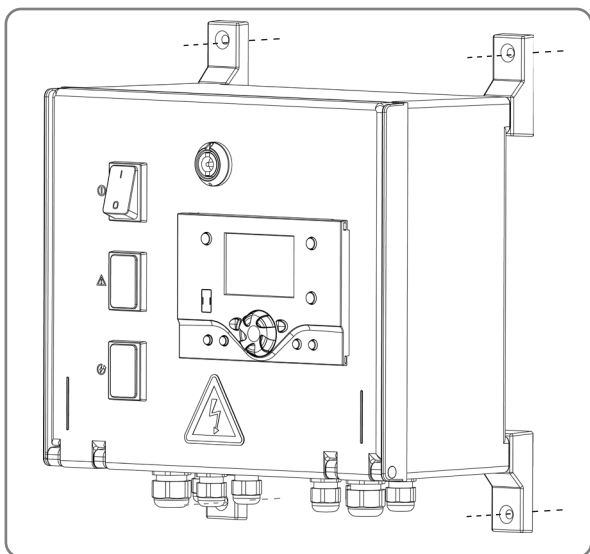

figure 5 - Screw locations

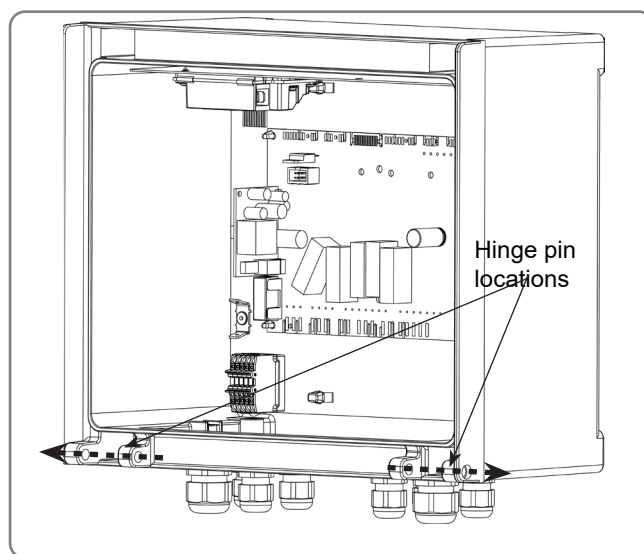

figure 6 - Door hinge pin locations

- Open and remove the door by removing the hinge pins shown in figure 6 from the outside.
- Attach the mounting feet using the four screws supplied in the bag.
- Refit the door by proceeding as for removal but in the reverse order.
- Mount the case level using the screws provided.

3.1.3. Version without mounting feet

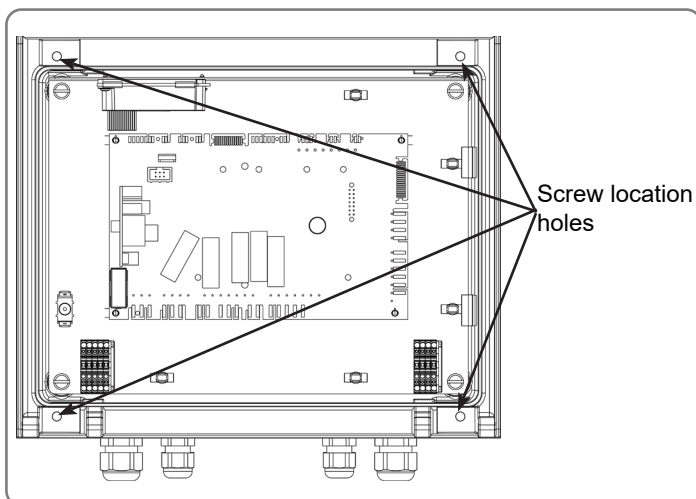

figure 7 - Screw locations

- Open and remove the door by removing the hinge pins shown in figure 6 from the outside.
- Insert the anchors into the wall (if required) using the holes in the case as a pattern, see figure 7.
- Mount the case level using the screws provided.
- Refit the door by proceeding as for removal but in the reverse order.

3.2. Installation of flow sensor in the tank or decoupling bottle

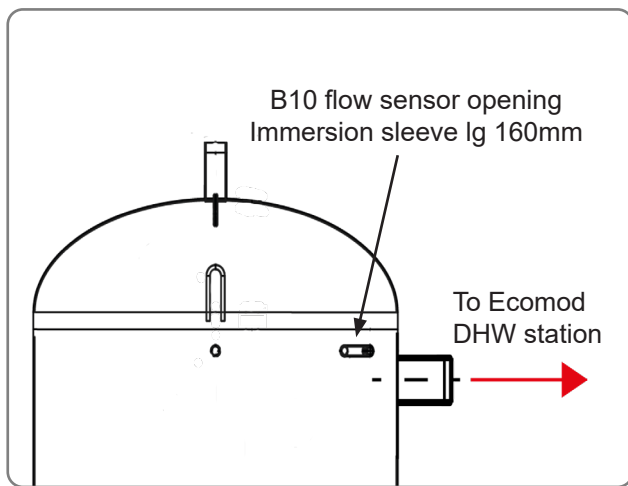

figure 8 - Flow sensor on decoupling tank

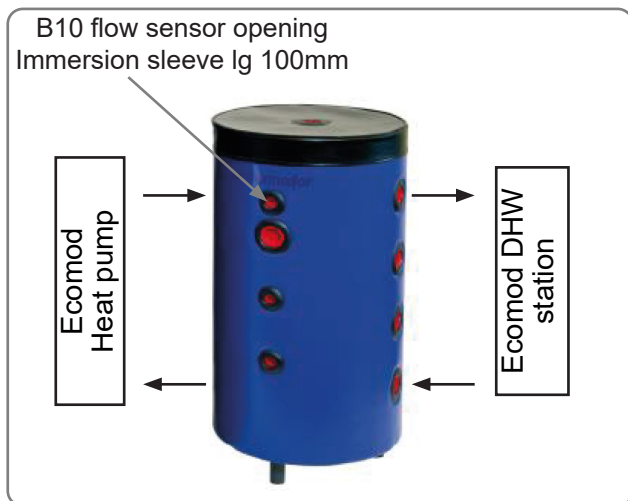

figure 9 - Flow sensor on decoupling bottle

The initial temperature sensor B10 must be located at the top of the water tank as close as possible to where the heating outlet connection. Refer to the drawings for the heating system design to determine the precise location.

Mount the specific Ecomod immersion sleeve supplied with the tank or bottle in the opening located in the upper section.

- on a bottle : 100mm immersion sleeve to be placed in the upper opening at 90° from the flow opening.
- on a primary water tank: 160mm immersion sleeve to be placed in the upper opening at 45° from the flow opening.

Temperature sensor B10 is inserted all the way into the immersion sleeve and held in place using the seal provided.



CAUTION:

Use the specific Ecomod immersion sleeve supplied with the tank or bottle.

3.3. Electrical connection



CAUTION: Do not pull the electrical cables and remove them from heat sources.



WARNING: Only carry out electrical connections, in particular connection to the main supply, when all other fitting and installation work is completed.



WARNING: Installations carried out by the customer (cable runs, gas or fuel pipes, etc.) must not be fitted to the Ecomod's jacket!

3.3.1. Installation passage ways

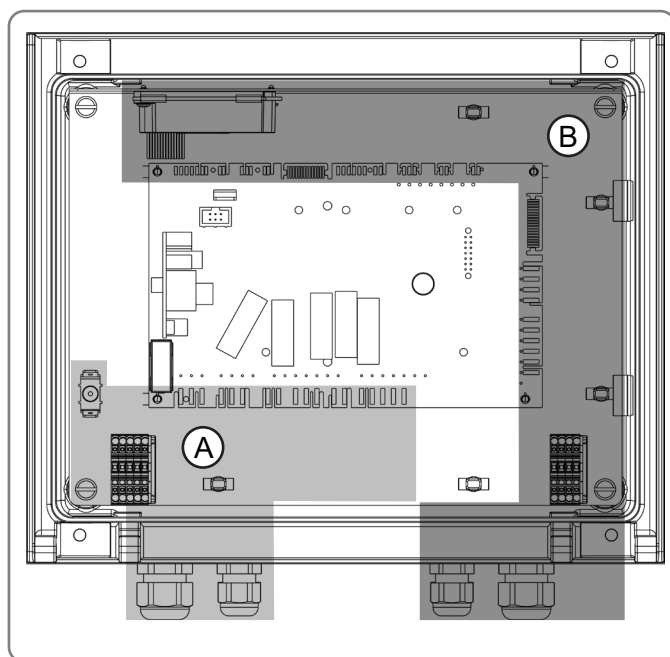

figure 10 - LV and ELV wire passage ways

- A Power cable passage area
(LV: between 50V AC and 400V AC).
- B Signal wire passage areas (sensors
sensors et communication)
(ELV: voltage lower than 20V DC).



DANGER: Comply with the cabling areas and separation of LV and VLV cables.

3.3.2. Ecomod Heat Pump Control wiring diagram

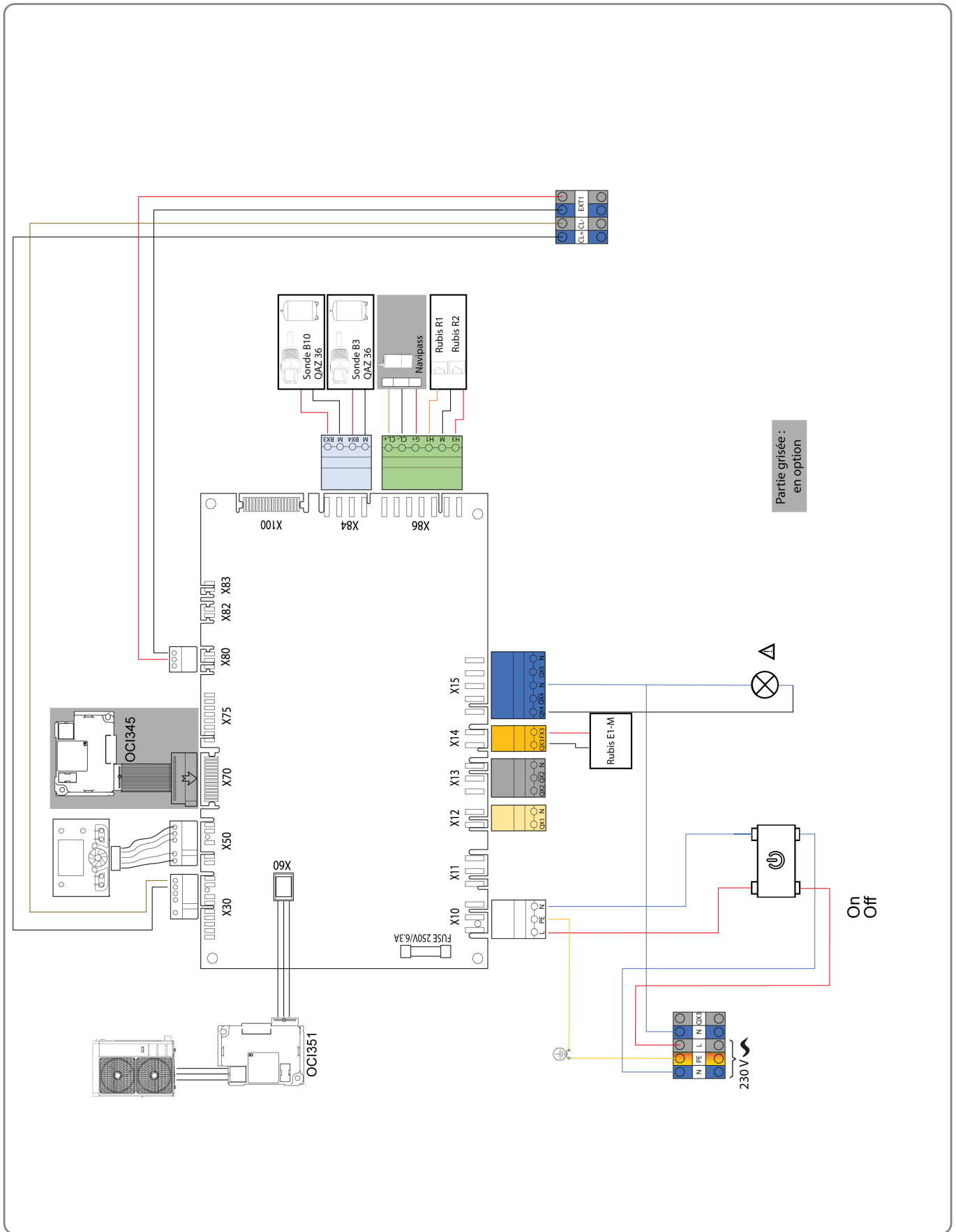
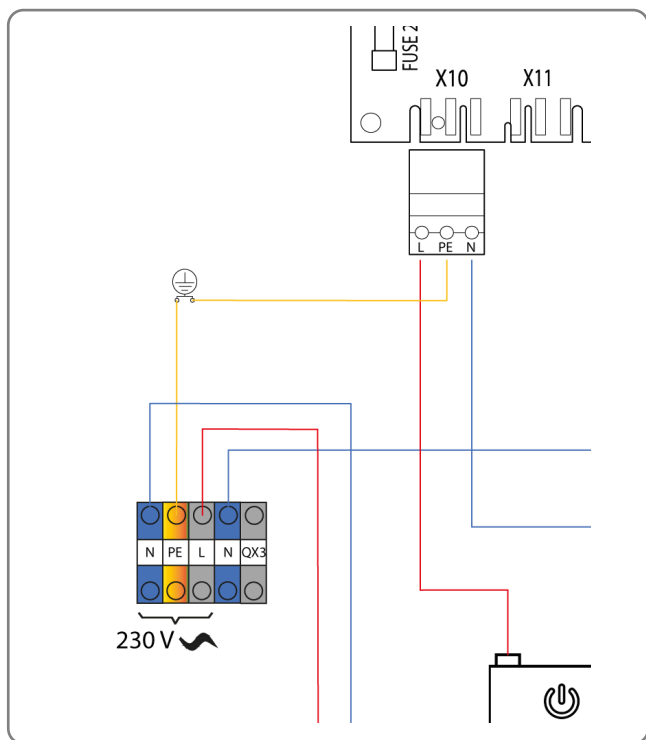

figure 11 - Ecomod Heat Pump Control wiring diagram

3.3.3. Ecomod Heat Pump Control main supply wiring



Mains supply for the Ecomod Heat Pump Control: 230 V AC 50 Hz
 Maximum intensity: 6.3 A
 Type of cable: 3 G 1.5 mm²

The installation is done directly by pressing with rigid cable or using a screw turner in case of use of flexible cable.
 The cable sections above are given as an indication and do not exempt the installer from checking that they correspond to the needs and meet the national and local standards in force. If a cable is damaged, it must be replaced by the manufacturer, its after-sales service or any person of similar qualification to avoid any danger.
 Tow presses must be tightened tightly enough to withstand cable traction up to 60N.

figure 12 - Connecting the mains supply for the Ecomod Heat Pump Control



CAUTION:

The Ecomod Heat Pump Control must be powered by special protected lines from the boiler room's electric panel via two-pole circuit breakers.

3.3.4. Heat pump communication bus connection

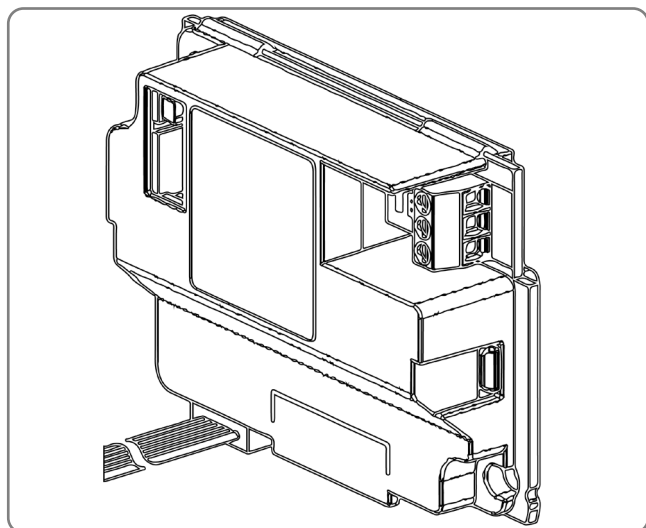

Connection of the communication cable between the heat pump and Ecomod Heat Pump Control with OCI351:

Ecomod Heat Pump Control controls the Ecomod heat pump via preset communication functions.

Connections are made by:

- Shielded twisted pair
- Max. length: 1000 m
- Section: 0.5mm²
- Bus termination : 120 Ohm

figure 13 - HP communication bus connection

		AHP60 14/18	AHP60 26/32	AHP60 50/70
Ecomod Heat Pump Control	A	X-5.2	XC-2.2	R+
	B	X-5.1	XC-2.1	R-
	REF	X-4.1	XC-1.1	GND

3.3.5. Connection to the main regulator

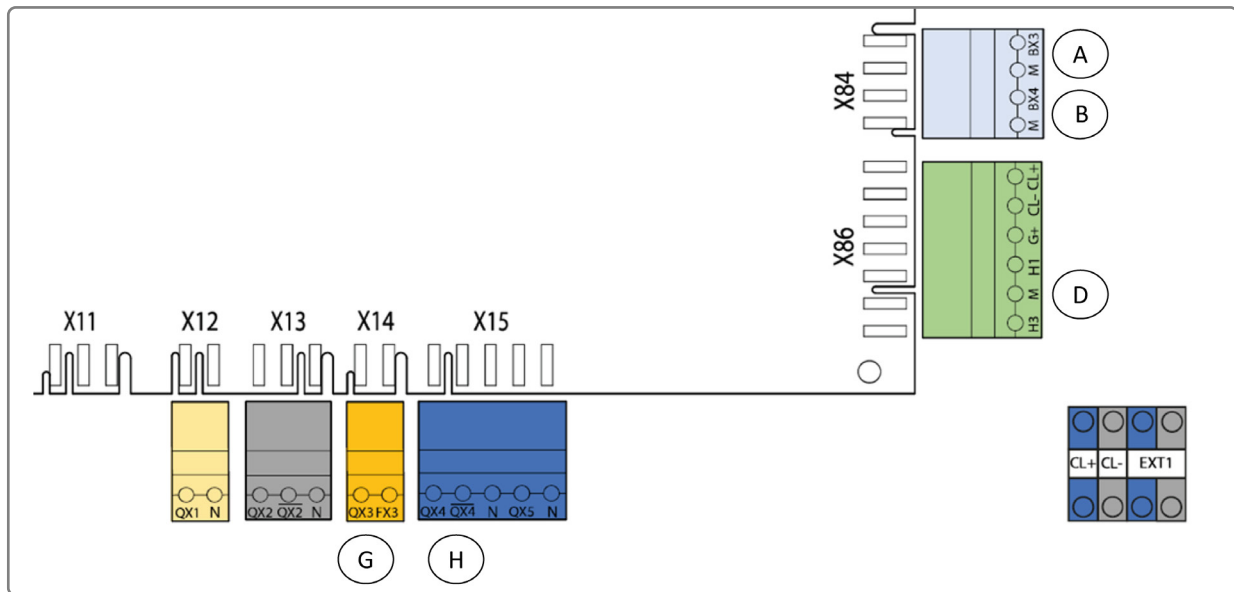

figure 14 - Connection to the main regulator

- A Connection of decoupling bottle flow sensor QAZ36.
- B Connection of DHW pre-heating tank sensor.
- D Connection of W3100 hydraulic station with H1-M = R1 (NO and Com respectively), and H3-M = R2 (NO and Com respectively)
- G Connection of Rubis E1
- H Connection of the HP(s) alarm summary relay output and the hydraulic station:
 Factory wired to the Ecomod Heat Pump Control alarm light
A 230V output can be wired in parallel to remotely report the data to a boiler room indicator or a PLC.

3.3.6. Changing the Fuse

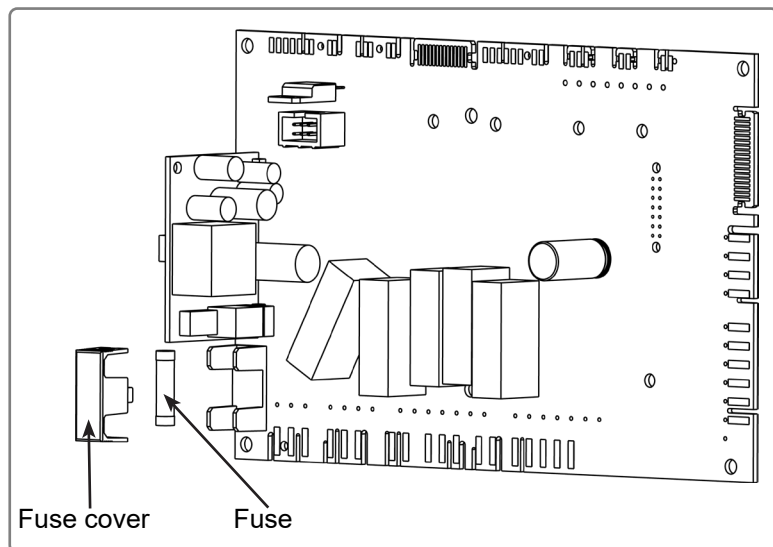

figure 15 - Fuse slot

- Set the switches to "Off".
- Switch off the electric power supply to the controller
- Open the door using the key.
- Remove the fuse cover.
- Remove and replace the fuse.
- Close the door and switch the power back on.

Fuse technical specifications:

Timed fuse

T 6.3A H 250V AC

5 x 20 mm

3.3.7. Closing the control panel

When all connections have been made, close the control panel.



WARNING:

To close the control panel, use the key provided.



CAUTION:

Ensure each cable gland is tight so that no connection inside the control panel can be attempted.

4. USER INTERFACE

4.1. Presentation of the interface

The Ecomod Heat Pump Control controller user interface comprises:

- An On/Off switch,
- An Ecomod system fault summary indicator light (whether alone or cascaded),
- A back-lit LCD display,
- Two function buttons
- A setting knob,



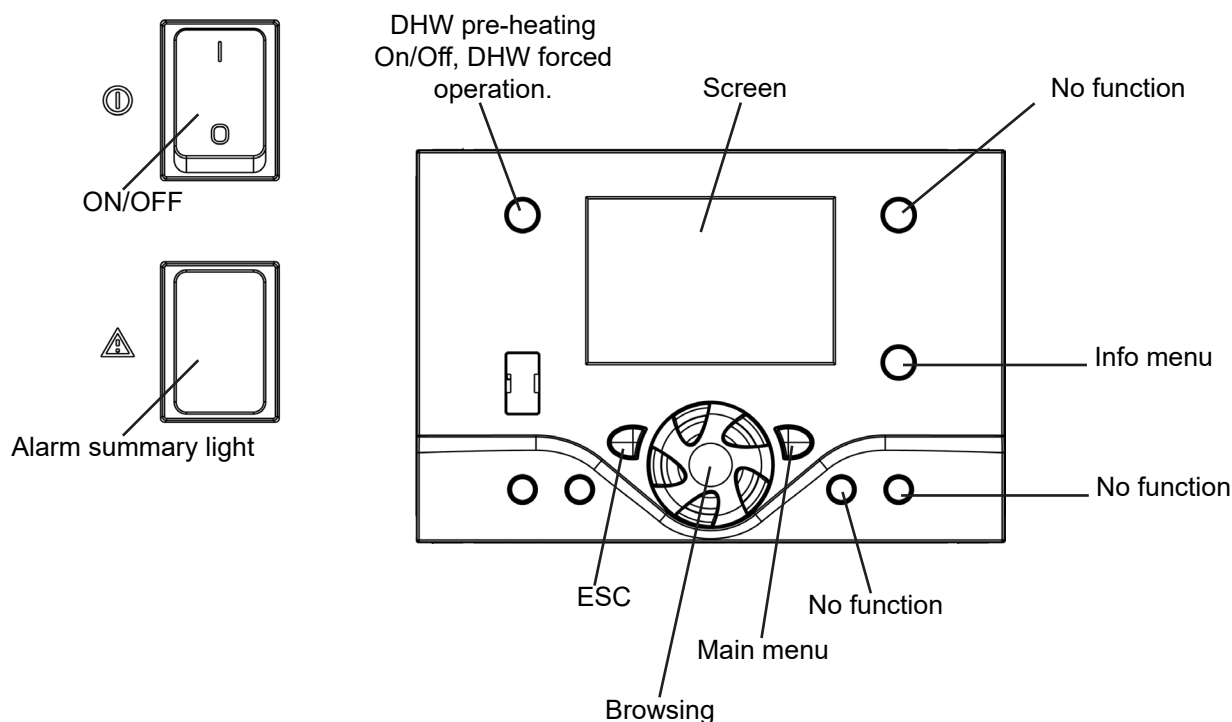

All customer settings, and any configuration are done through this interface. It also allows viewing information on heat pump operation.

4.2. Display



The screen summarises heat pump status: operating regime, time, schedule programme, temperature, any fault condition).

Pictograms:

- | | |
|--|--|
|  Alarm | PROG Programming |
|  Compressor |  Process in progress. |
| No. Parameter number |  Maintenance |
| INFO Information | |

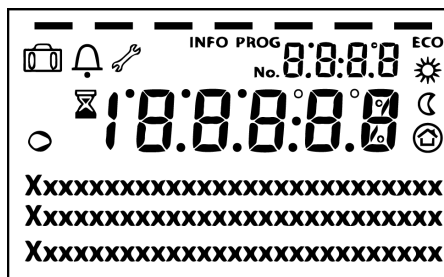

4.2.1. Browsing between the different screens

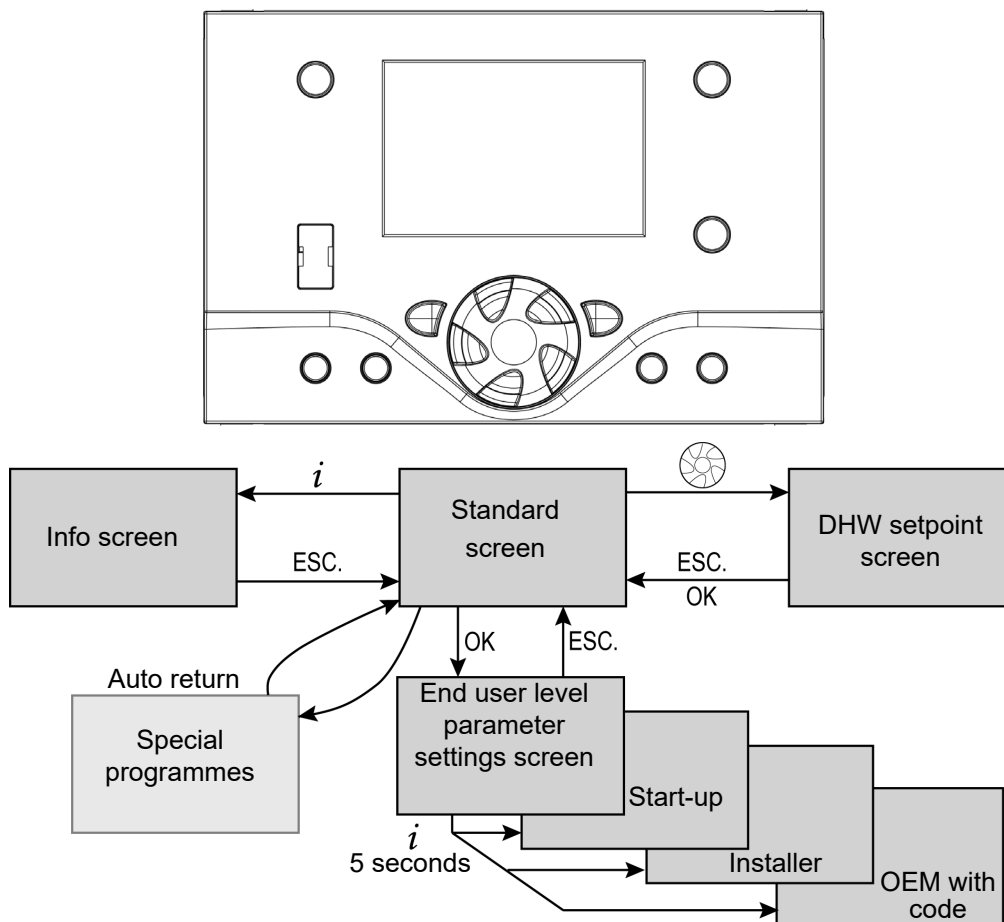

4.2.2. Ecomod HMI preset standard browser display

The basic display of the Ecomod Heat Pump Control in DHW pre-heating mode includes the following information:

- Time
- HP status
- Compressor On indicator light
if the compressor is in operation
- DHW status
If the W3100 regulator is connected

Further information is available when your press the *i* button

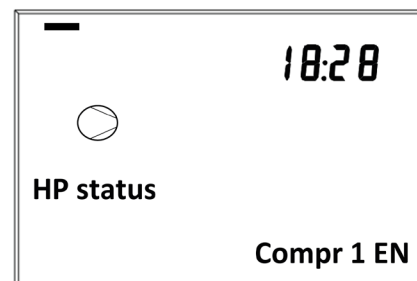
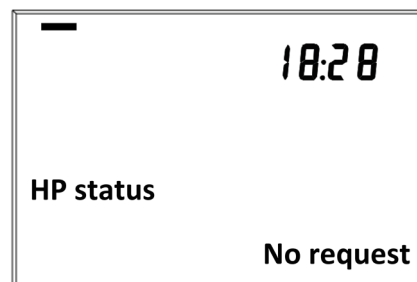

4.3. Fault display

When a non-blocking fault occurs, a small bell appears in the upper left corner of the display. To display the fault, press the information key *i*. This type of fault does not cause operation to be blocked, requiring manual intervention..

Once the source of the fault has been removed, the bell disappears automatically.

When a fault causes the heat pump to trip, the fault code and its label are permanently displayed on the screen. Similarly, a small bell appears at the top LH corner of the display.

To reset the heat pump controller, remove the source of the fault then press the reset button.

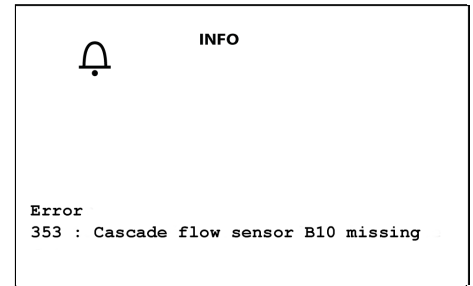
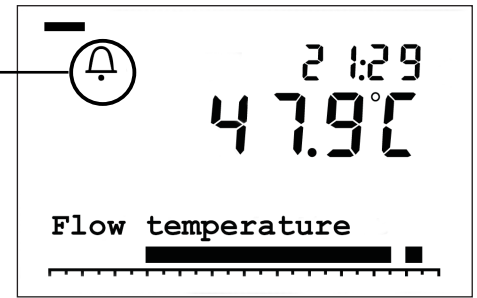

4.4. Ecomod HMI browsing

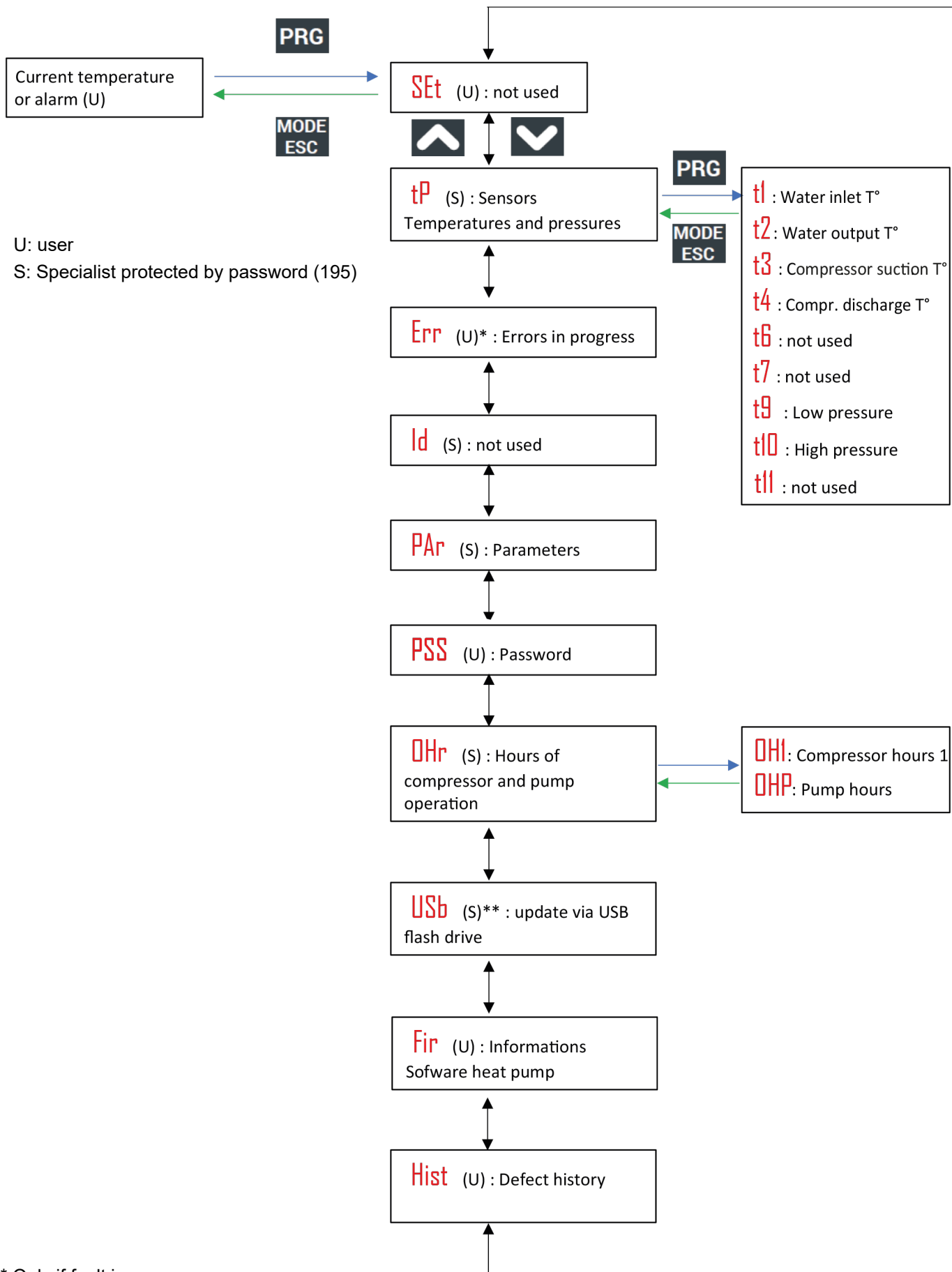

* Only if fault in progress

** Only if USB drive detected with suitable files

OH2: available only on Ecomod AHP60 50 or 70kW

4.5. HP status

From the basic display, you can scroll basic heat pump information (see list below).

Access	Setting	Exit
<i>i</i>		ESC

1	HP status
2	DHW status
3	Outdoor temperature
4	DHW temperature
5	Heat pump return temperature
6	HP flow temperature
7	Line start temperature
8	Compressor hours of operation

4.6. Settings

Depending on the functions commanded, there are different levels of access to the settings. There are 3 access levels:

U: End user

M: Commissioning (reception, starting up),

S: Specialist (technical level).

4.6.1. "End user" level parameter settings

The "end user" level configuration mode is accessed from the standard display by pressing the OK key.

The "PROG" pictogram and the first two sections are displayed on the screen.

The setting knob is used to scroll through the list of parameters. Once the parameter to be modified has been reached, press OK. The parameter values flash. Adjust this value using the knob.

The new value is validated by pressing OK.

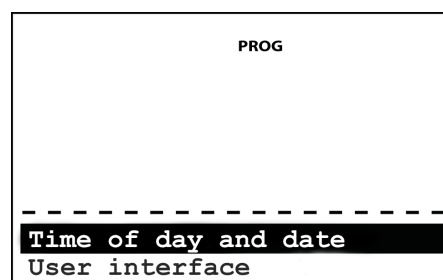

4.6.2. "Commissioning" and "Specialist" level parameter settings

From the standard display, the "Commissioning" and "Specialist" parameter setting modes are accessed by pressing the OK button then the information key *i* for 5 seconds.

Use the knob to go to the desired level: *Commissioning* or *Specialist* then validate your choice with OK.

The *Commissioning* access level includes the *End user* level. In the same way, the *Specialist* level integrates the *Commissioning* level.

4.6.3. Adjusting the various parameters

From the main menu, after reaching the desired level:

- Turn the knob to scroll through the menu.
- When the desired menu is displayed, press OK to validate.
- Turn the knob to adjust the setting.
- Press OK to confirm the setting.

If no setting is made for 8 minutes, the screen returns automatically to the basic display.

5. OPERATING CYCLES

5.1. Heat Pump start-up

When there is a request for heat, the heat pump start-up cycle is as follows:

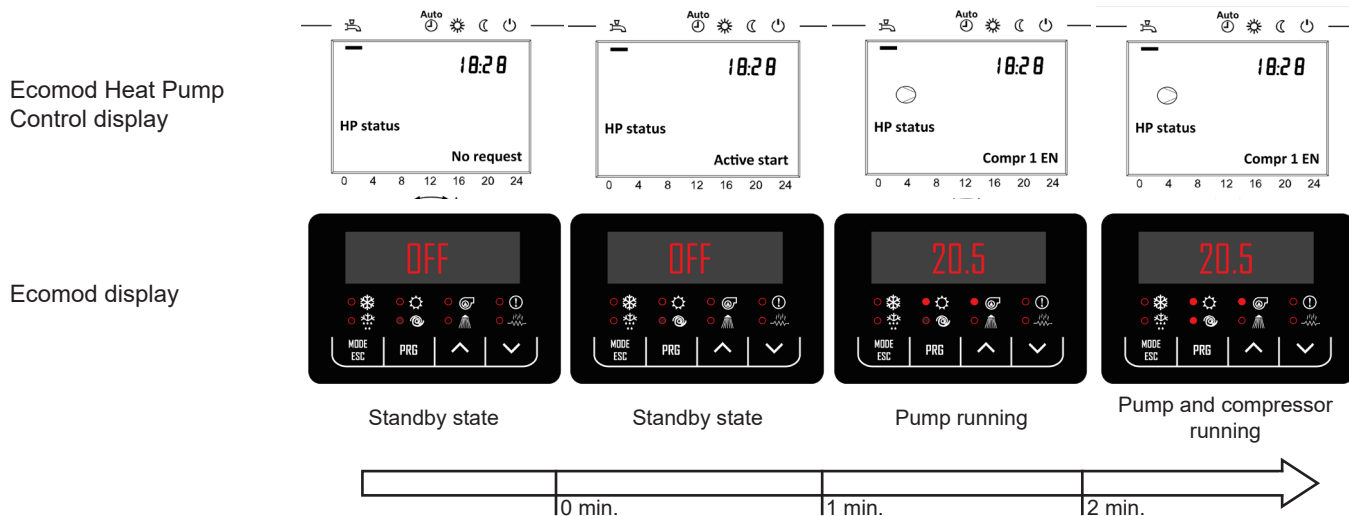

5.2. Heat pump shutdown:

When there is no longer any request for heat, the following heat pump shutdown cycle is applied:

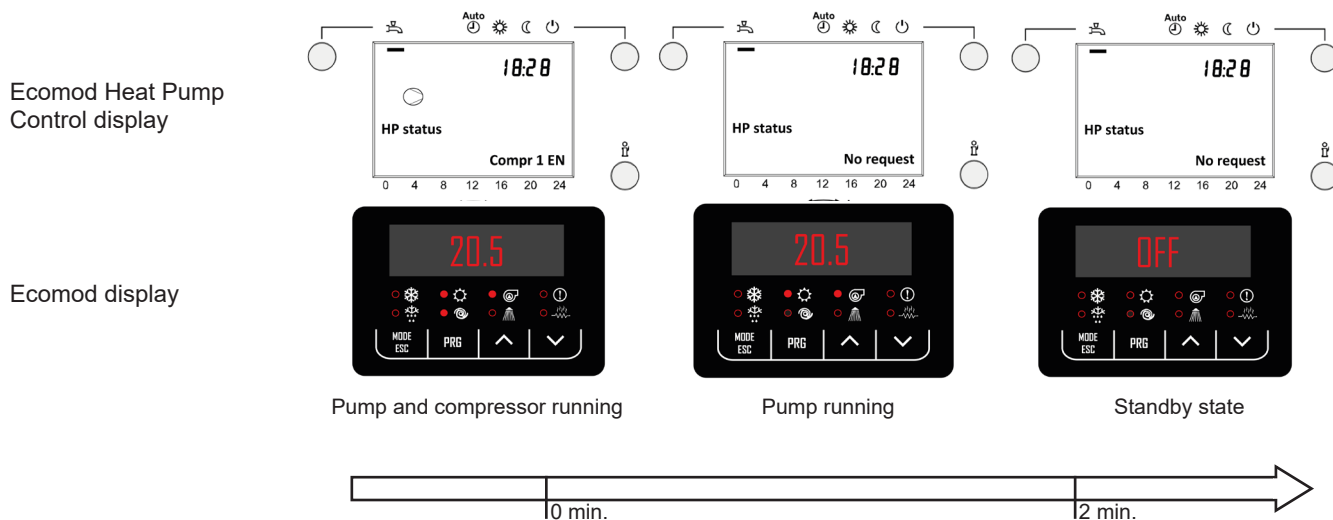

Note: The system always applied a minimum 5 minute stop time before restarting the compressor to avoid cycles that are too close together

5.3. Cascade cycles

When the heat pump cannot meet the demand for heat by itself, the slave heat pumps are released:

- If the master heat pump has been running for over 10 minutes
- And, if the master heat pump is running at a high compressor power level or if the system output temperature has not been met for a long time.

6. DIAGNOSTIC HELP

Code	Fault relay triggered?	Description	1st diagnostic	Heat pump running?
50	YES	DHW temperature sensor B3 fault	Check the pre-heating tank temperature sensor.	NO
76	YES	Special sensor 1 fault.	Check special sensor 1 declared on input Bx.	YES
81	YES	Short circuit fault on the LPB bus, or no LPB bus power.	Check that the two bus wires are not short circuited or that the DB and MB terminals are not reversed on one of the heat pumps.	YES
82	NO	LPB address collision.	Check the (6600) LPB addresses of the regulators.	NO
84	YES	BSB address collision.	Check for addressing conflicts on BSB accessories.	YES
100	NO	Two regulators with master clock.	Check clock slaving on a regulator (6640).	YES
102	NO	Time setting lost after a power break.	Set the time and leave the regulator powered up for a few minutes.	YES
105	NO	Maintenance message.	Reset the maintenance counters in the maintenance menu.	YES
134	YES	Heat pump alarm/Ecomod fault summaries.	Check the status and presence of a fault on the Ecomod HMI.	NO
174	YES	Hydraulic station error	Note the error code on the W3100 of the hydraulic station and consult its manual if necessary	YES
324	NO	Same Bx sensors.	Two Bx inputs are declared with the same function, check Bx input declarations.	YES
325	NO	Same Bx sensors.	Two Bx inputs are declared with the same function, check Bx input declarations.	YES
330	NO	Input Bx1 without any function.	Check that no sensor is connected to the Bx input if no function is assigned to it.	YES
332	NO	Input Bx3 without any function.	Check that no sensor is connected to the Bx input if no function is assigned to it.	YES
333	NO	Input Bx4 without any function.	Check that no sensor is connected to the Bx input if no function is assigned to it.	YES
354	YES	Special sensor 2 fault.	Check special sensor 2 declared on input Bx.	YES
489	NO	Cascade master missing.	Check that the cascade master is powered up, check regulator addressing to the 6600.	NO
495	YES	Modbus communication error.	Check OCI 351 and Ecomod wiring, check that the Ecomod is powered up.	NO

Maintenance code	Maintenance description
6	The heat pump operating hours meter has reached the limit set for preventive maintenance.
7	The heat pump start-up counter has reached the limit set for preventive maintenance.
8	Compressor start-up frequency is too high, analyse the malfunction <i>Acknowledgement of this error message is performed via a reset of the start-up counter in the 'maintenance / special programmes' parameter 7073 Current number of start-ups</i>
17	The heat pump month counter has reached the limit set for preventive maintenance.

Other symptoms	Description	1st diagnostic
No display on the LCD interface	Ecomod Heat Pump Control fuse fault	Look for the origin of the overload, correct the fault, then replace the fuse.
The display is always coming on and going out.	Spurious supply on the BSB internal bus.	Incorrect accessory connection on the CL+/CL-/G+ connector (Navipass, etc.).
"No connection" display.	Communication error on the BSB internal bus.	Check the connection of the screen and regulation ribbon cables and the accessories connected to CL+/CL-/G+ (Navipass Modbus)
Operation button is locked in stand-by.	Cannot select the heating circuit or hot water mode from the front panel buttons.	Cannot control heating or hot water production from the controller regulation system.
Operation is locked in stand-by.	Cannot perform actions using front panel buttons.	Screen locking is enabled. It can be disabled from the user interface menu in parameter 26.
Programming is locked in stand-by.	Programming cannot be changed.	Programming locking is enabled. From the parameter to change, press OK and ESC together for 5 seconds.

Special programmes code	Special programmes description
308	Enable output test via parameter 7700
311	Heat pump test enabled

7. LIST OF PARAMETERS

Line No.	Programming	Access	See subsection..., page...	Line No.	Programming	Access	See subsection..., page...
Time setting				5933	Sensor input BX4	s	8.5.1.1, page 39
1	Hours / minutes		8.1.1, page 31	5950	H1 input function	s	8.5.1.1, page 39
2	Day / month		8.1.1, page 31	5951	H1 contact action direction	s	8.5.1.1, page 39
3	Year		8.1.1, page 31	5960	H3 input function	s	8.5.1.1, page 39
5	Start of summer time		8.1.1, page 31	5961	H3 contact action direction	s	8.5.1.1, page 39
6	End of summer time		8.1.1, page 31	6200	Register sensor	s	8.5.2.4, page 43
User interface				6205	Reset parameters	s	8.5.2.4, page 43
20	Language		8.1.2, page 31	LPB network			
22	Temporary		8.1.2, page 31	6600	Appliance address	s	8.6.1, page 44
26	Operation locking		8.1.2, page 31	6601	Segment address	s	8.6.1, page 44
27	Programming locking		8.1.2, page 31	6612	Alarm timeout	s	8.6.2, page 44
28	Direct adjustment		8.1.2, page 31	6640	Clock operation	s	8.6.3, page 44
29	Units		8.1.2, page 31	Error			
70	Software version		8.1.3, page 32	6700	In progress		8.7.1, page 45
Timer programme 4: Domestic hot water (DHW) production				6800	History Error 1		8.7.2, page 45
560	Preselection		8.1.3.1, page 33	6802	History Error 2		8.7.2, page 45
561	1st period start time		8.1.3.1, page 33	6804	History Error 3		8.7.2, page 45
562	1st period stop time		8.1.3.1, page 33	6806	History Error 4		8.7.2, page 45
563	2nd period start time		8.1.3.1, page 33	6808	History Error 5		8.7.2, page 45
564	2nd period stop time		8.1.3.1, page 33	6810	History Error 6		8.7.2, page 45
565	3rd period start time		8.1.3.1, page 33	6812	History Error 7		8.7.2, page 45
566	3rd period stop time		8.1.3.1, page 33	6814	History Error 8		8.7.2, page 45
576	Default values		8.1.3.1, page 33	6816	History Error 9		8.7.2, page 45
Domestic hot water				6818	History Error 10		8.7.2, page 45
1610	Comfort setpoint		8.2.1, page 35	Maintenance/Special operation			
1680	Rate switching		8.2.1, page 35	7070	Heat pump maintenance interval	s	8.8.1, page 46
Heat pump				7071	Heat pump time since maintenance	s	8.8.1, page 46
2812	Limit use T° outdoor min air	s	8.3, page 36	7072	Start Max. compr1/op. hrs.	s	8.8.1, page 46
2813	Limit use T° outdoor max air	s	8.3, page 36	7073	Start actual compr1/op. hrs.	s	8.8.1, page 46
DHW tank				7202	Heat pump start-up	s	8.8.3, page 47
5008	Charging time		8.4.1, page 36	7207	Heat pump power modulation selection	s	8.8.3, page 47
5020	Outlet setpoint T° raise		8.4.1, page 36	7214	Test funct. mode		8.8.3, page 47
5036	Increase of charge by 60°C		8.4.1, page 36	Modbus slave diagnostics			
Configuration				7611	UX signal input port 1	s	8.11.3, page 53
5700	Preselect		§8.5.1.1, page 39	7621	UX signal input port 2	s	8.11.3, page 53
5890	Relay output QX1	s	8.5.2, page 40	7631	UX signal input port 3	s	8.11.3, page 53
5891	Relay output QX2	s	8.5.2, page 40	Inputs/Outputs test			
5892	Relay output QX3	s	8.5.1.1, page 39	7700	Relay test	MES	8.9.1, page 48
5894	Relay output QX4	s	8.5.2, page 40	7804	Temperature sensor BX1		8.9.2, page 49
5895	Relay output QX5	s	8.5.2, page 40	7806	Temperature sensor BX3		8.9.2, page 49
5930	Sensor input BX1	s	8.5.2, page 40	7807	Temperature sensor BX4		8.9.2, page 49
5932	Sensor input BX3	s	8.5.1.1, page 39				

Line No.	Programming	Access	See subsection..., page...	Line No.	Programming	Access	See subsection..., page...
7840	H1 voltage signal	MES	8.9.3, page 49	8131	Generator 16 status		8.11.1, page 52
7841	H1 contact status	MES	8.9.3, page 49	8138	Cascade starting temperature		8.11.1, page 52
7845	H2 voltage signal module 1		8.9.3, page 49	8139	Cascade starting setpoint		8.11.1, page 52
7846	H2 contact status module 1		8.9.3, page 49	8140	Cascade return temperature	s	8.11.1, page 52
7848	H2 voltage signal module 2		8.9.3, page 49	8150	Switching sequence current generator	s	8.11.1, page 52
7849	H2 contact status module 2		8.9.3, page 49	Diagnostics heat generation			
7851	H2 voltage signal module 3		8.9.3, page 49	8400	Compressor 1		8.11.2, page 52
7852	H2 contact status module 3		8.9.3, page 49	8410	Heat pump return temperature		8.11.2, page 52
7854	H3 voltage signal	MES	8.9.3, page 49	8411	HP flow T° setpoint		8.11.2, page 52
7855	H3 contact status	MES	8.9.3, page 49	8412	HP flow temperature		8.11.2, page 52
Status				8413	Compressor modulation		8.11.2, page 52
8003	DHW status		§ 8.10, page 50	8415	Hot gas temperature		8.11.2, page 52
8006	HP status		§ 8.10, page 51	8434	Suction temperature		8.11.2, page 52
Cascade diagnostics				8450	Compressor hours of operation		8.11.2, page 52
8100	Generator 1 priority		8.11.1, page 52	8451	Compressor start counter	s	8.11.2, page 52
8101	Generator 1 status		8.11.1, page 52	8585	Line start temperature		8.11.2, page 52
8102	Generator 2 priority		8.11.1, page 52	Consumer diagnostic			
8103	Generator 2 status		8.11.1, page 52	8700	Outside temperature		§ 8.11.4, page 53
8104	Generator 3 priority		8.11.1, page 52	8701	Min outside temperature. reset the min. outdoor T°		§ 8.11.4, page 53
8105	Generator 3 status		8.11.1, page 52	8702	Max outside temperature. reset the max. outdoor T°		§ 8.11.4, page 53
8106	Generator 4 priority		8.11.1, page 52	8703	Attenuated outside temperature. reset the attenuated outdoor T°		§ 8.11.4, page 53
8107	Generator 4 status		8.11.1, page 52	8704	Mixed outside temperature		§ 8.11.4, page 53
8108	Generator 5 priority		8.11.1, page 52	8820	DHW pump		§ 8.11.4, page 53
8109	Generator 5 status		8.11.1, page 52	8830	DHW temperature 1 (B3)		§ 8.11.4, page 53
8110	Generator 6 priority		8.11.1, page 52	8831	DHW setpoint		§ 8.11.4, page 53
8111	Generator 6 status		8.11.1, page 52	8832	DHW temperature 2 (B31)		§ 8.11.4, page 53
8112	Generator 7 priority		8.11.1, page 52	8840	Number of DHW pump hours		§ 8.11.4, page 53
8113	Generator 7 status		8.11.1, page 52	8841	DHW pump starts counter		§ 8.11.4, page 53
8114	Generator 8 priority		8.11.1, page 52	8850	Temperature from line		§ 8.11.4, page 53
8115	Generator 8 status		8.11.1, page 52	8951	Line start setpoint temperature		§ 8.11.4, page 53
8116	Generator 9 priority		8.11.1, page 52	9016	Special temperature 1		§ 8.11.4, page 53
8117	Generator 9 status		8.11.1, page 52	9017	Special temperature 2		§ 8.11.4, page 53
8118	Generator 10 priority		8.11.1, page 52	9031	Relay output QX1		§ 8.11.4, page 53
8119	Generator 10 status		8.11.1, page 52	9032	Relay output QX2		§ 8.11.4, page 53
8120	Generator 11 priority		8.11.1, page 52	9033	Relay output QX3		§ 8.11.4, page 53
8121	Generator 11 status		8.11.1, page 52	9034	Relay output QX4		§ 8.11.4, page 53
8122	Generator 12 priority		8.11.1, page 52	9035	Relay output QX5		§ 8.11.4, page 53
8123	Generator 12 status		8.11.1, page 52	s: specialist level access, see §4.6.2 "Commissioning" and "Specialist" level parameter settings			
8124	Generator 13 priority		8.11.1, page 52				
8125	Generator 13 status		8.11.1, page 52				
8126	Generator 14 priority		8.11.1, page 52				
8127	Generator 14 status		8.11.1, page 52				
8128	Generator 15 priority		8.11.1, page 52				
8129	Generator 15 status		8.11.1, page 52				
8130	Generator 16 priority		8.11.1, page 52				

8. PARAMETERS

8.1. "User interface" parameters

8.1.1. Time setting

Line no.	Programming	Possible values
1	Hours / minutes	00:00 ... 23:59
2	Day / month	01:01... 31.12
3	Year	1900 ... 2099
5	Start of summer time	01:01... 31.12
6	End of summer time	01:01... 31.12

The controller is provided with a yearly clock that displays the time, day and date. So that the programming sequences can operate properly, the time and the date must be correctly set on the clock.

N.B: Toggling between summer and winter time

Dates have been programmed for the change between summer and winter times. The time changes automatically at 2 am (winter time) to 3 am (summer time) or from 3 am (summer time) to 2 am (winter time) on the first Sunday after the respective dates.

8.1.2. User interface

Line no.	Programming	Possible values
20	Language	English Deutsch Français Italiano Nederlands Español
22	Temporary	temporary permanent
26	Operation locking	stop start
27	Programming locking	stop start
28	Direct adjustment	Automatic storage Storage with confirmation
29	Units	°C, bar °F, PSI

Info. (22):

- **Temporary:**

After pressing the "Infos" button, the display returns to the basic "preset" display after eight minutes or by pressing the Operating modes button.

- **Permanent:**

After pressing the "Infos" button, the display returns to the "new" standard display after a maximum of eight minutes. The last information selected is visible on the new basic display.

Operation locking (26):

If the operation locking function is enabled, the following control elements cannot be adjusted any longer:

Heating circuit mode, hot water mode, temp. room temperature comfort setpoint (button), occupied button.

Programming locking (27):

If the programming locking function is enabled, the following control elements cannot be adjusted any longer:

- **Temporary programming suspension**

Programming locking may be temporarily disabled at the programming level. **To do this, press the OK and ESC buttons together for at least 3 seconds.** The programming locking function temporary suspension remains effective until the user quits the programming level.

- **Temporary programming suspension**

First perform a temporary suspension then cancel "Programming locking" on line 27.

Direct adjustment (28):

- **Automatic**

A correction of the setpoint value with the knob is adopted without any specific validation (timeout) or by pressing the OK button.

- **With validation**

A correction of the setpoint value with the knob is only validated after pressing the OK button.

8.1.3. Software version

Line no.	Programming
70	Software version

The indication provides the current version of the user interface.

8.1.3.1. Time programme (DHW circuits)

Line no. DHW	Programming	Possible values
560	Preselection	Mon-Sun Mon-Fri Sat-Sun Mon...Sunday
561	1st period start time	00:00 ... 24:00
562	1st period stop time	00:00 ... 24:00
563	2nd period start time	00:00 ... 24:00
564	2nd period stop time	00:00 ... 24:00
565	3rd period start time	00:00 ... 24:00
566	3rd period stop time	00:00 ... 24:00
576	Default values	No Yes

The Ecomod Heat Pump Control provides a DHW pre-heating function via the Ecomod heat pumps and a plate exchanger.

In order to optimiser product performance, DHW pre-heating by the Ecomod is programmed for specific time ranges.

The parameters shown above are used for this time range definition function.

Example of settings for a charge between 22:00 and 06:00 the next day

If no setting is made for 8 minutes, the screen returns automatically to the basic display.

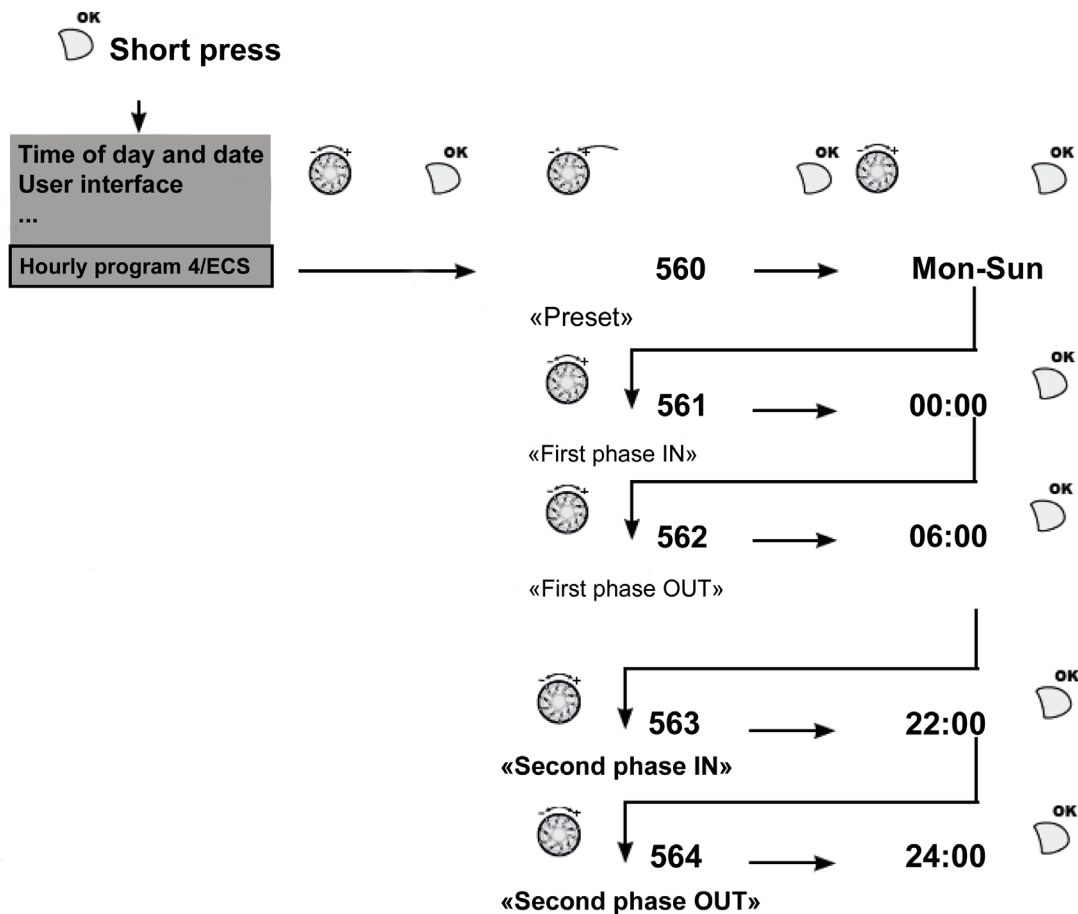

INFORMATION:

Every time the user accesses the "DHW timer programme 4" menu, the first parameter displayed is 560 "Preset". This always displays the default values "Mon-Sun" regardless of any programming done previously.

8.2. “DOMESTIC HOT WATER (DHW)” PARAMETERS

The Ecomod Heat Pump Control recognises that it has to control a DHW circuit when a sensor is connected to its B3 input.

The Ecomod Heat Pump Control can control a DHW actuator (Q3 DHW pump to be defined in QX3).

The names of the sensor and the pump used are:

	Sensor	Pump
DHW	B3	Q3

The following functions are available on the DHW circuit:

- Adjustment of timer programmes
- Adjustment of settings
- DHW storage tank with charge management

The Ecomod Heat Pump Control displays the DHW and DHW tank menus when a sensor is connected to its B3 input.

The control adjusts the DHW temperature to the desired setpoint according to the timer programme.

8.2.1. Basic settings

8.2.1.1. Setpoint value

Line no.	Programming	Possible values
1610	Comfort setpoint	8 ... 80°C

The above setpoint corresponds to the DHW pre-heating setpoint for defined time ranges.

The default setpoint is 50°C. Adjusting it leads to changes in product performance.

8.2.1.2. Rate switching

Line no.	Programming	Possible values
1680	Rate switching	none off on

In the case of external switching via the Hx input, the rate to be switched to should be defined in advance.

This parameter therefore ensures that the system works correctly once the plate exchanger regulator has been connected.

The default value: is “off”.

8.3. "Heat pump" parameters

The Ecomod heat pump produces heat within a preset outdoor temperature range. Beyond this range, the Ecomod Heat Pump Control forces the Ecomod to switch off.

Line no.	Programming	Possible values
2812	Limit use T° outdoor min air	-50°C ... 0 °C
2813	Limit use T° outdoor max air	0°C ... 50 °C

8.4. "DHW TANK" parameters

8.4.1. Charge regulation*

The Ecomod product ensures gradual pre-heating of the DHW over the defined time range. This operating mode allows optimal system performance outside the DHW draw-off phases.

The parameters and the diagram below describe the DHW charge regulation.

Line no.	Programming	Possible values
5008	DHW start of charge delay	0 ... 30 min

This parameter allows the heat production provided by the Ecomod to be delayed at the start of the time range.

This keeps temperatures in the hydraulic circuit even before the DHW pre-heating starts.

Line no.	Programming	Possible values
5020	Flow set T° over-value at charge start	0...30 °C

The heat production setpoint transmitted to the Ecomod generator is higher than the above parameter at charge start.

Line no.	Programming	Possible values
5036	Flow set T° over-value at charge end	0 ... 30 °C

The heat production setpoint transmitted to the Ecomod generator at the end of charging corresponds to the raised DHW setpoint for the above parameter

* = *restricted access level*

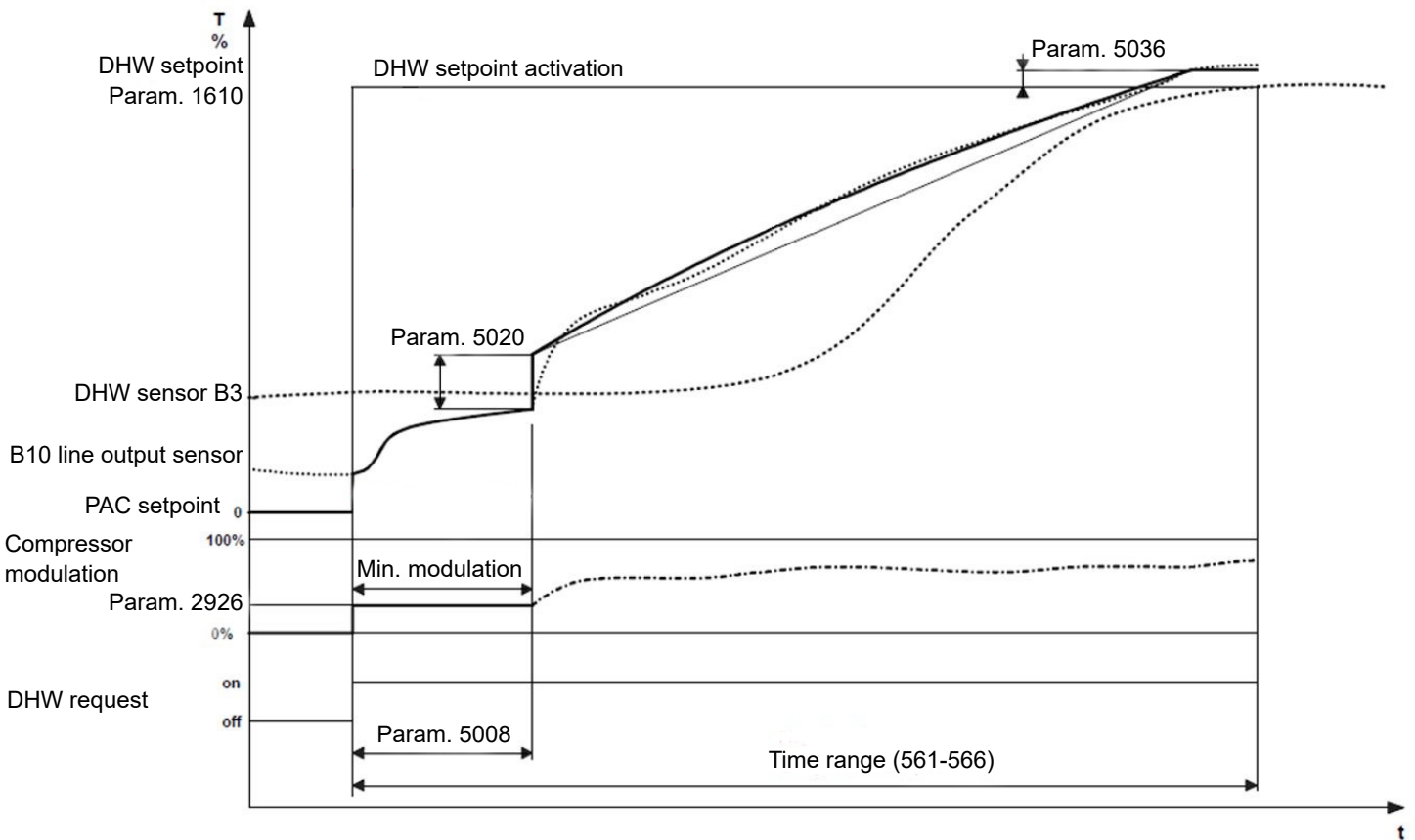

Charge regulation logic in time range:

DHW charging is carried out gradually over a defined time range. During this time period, the DHW temperature setpoint changes continuously in order to reach the desired final setpoint at the end of the DHW charging. The setpoint transmitted to the Ecomod producer is adjusted respectively throughout the charging period in order to meet the needs of the DHW setpoint.

In order to correctly define the starting point for this gradual setpoint, the Ecomod generator is released at its minimum modulation, and the plate exchanger is released.

In this way, temperatures in the circuit are kept even for a predefined period of time. The generator is then free to follow the appropriate modulation to meet the needs of the set point at all times.



INFORMATION: This operating mode is the only one authorised for the hot water production.

8.5. "Configuration" settings

The heat pump controller must be properly configured to adapt to boiler room demands for Ecomod type DHW pre-heating applications only.

It has four configurable 230V outputs (QX1, QX2, QX4, and QX5), one configurable dry contact output (QX3), three configurable sensor inputs (BX1, BX3 and BX4) and two 0...10 volt or on/off inputs (H1 and H3).

The BX3 input is used for the B10 decoupling bottle sensor on controller No.1.

The QX3 output is used to control the hydraulic station on controller No.1.

Output QX4 is used for the remote alarm function on each controller.



INFORMATION:

The QX4 output must be a summary of installation faults that includes the hydraulic station. It is not possible to distinguish between faults from specific Ecomod Heat Pump Control units in a cascade. To distinguish between the faults from each heat pump, connections must be made to the programmable 230V output from each Ecomod. Refer to the Ecomod instructions

Heat pump controller inputs / outputs	Configuration after setting via preselect P5700
QX1	-
QX2	-
QX3	Plate exchanger regulation control
QX4	Alarm relay K10
QX5	-
BX1	-
BX3	B10 line output sensor
BX4	DHW sensor B3
H1	Plate exchanger regulation ON status return
H3	Plate exchanger regulation fault return



WARNING:

The factory configuration is not suitable for Ecomod use. Only pre-selects 5 to 8 are suitable (see chapter 8.5.1.1)

8.5.1. Hydraulic configuration

8.5.1.1. Assigning the Ecomod model and the application*

Line no.	Programming
5700	Preselect

This parameter is used to preset a number of values that ensure a match between the Ecomod Heat Pump Control heating or hot water application and the model of the Ecomod used in the installation.

Line no.	Function	5 Ecomod AHP60 14 18kW	6 Ecomod AHP60 26 32kW	7 Ecomod AHP60 50kW	8 Ecomod AHP60 70kW
5892	Relay output QX3	DHW pump/valve Q3	DHW pump/valve Q3	DHW pump/valve Q3	DHW pump/valve Q3
5894	Relay output QX4	Alarm output K10	Alarm output K10	Alarm output K10	Alarm output K10
5932	Sensor input BX3	B10 line output sensor	B10 line output sensor	B10 line output sensor	B10 line output sensor
5933	Sensor input BX4	DHW sensor B3	DHW sensor B3	DHW sensor B3	DHW sensor B3
5950	H1 input function	Switching of heating circuit + DHW operation	Switching of heating circuit + DHW operation	Switching of heating circuit + DHW operation	Switching of heating circuit + DHW operation
5951	H1 input function action direction	Normally closed	Normally closed	Normally closed	Normally closed
5960	H3 input function	Error/alarm message	Error/alarm message	Error/alarm message	Error/alarm message
5961	H3 input function action direction	Operation	Operation	Operation	Operation

* = restricted access level

8.5.2. Configuring Ecomod Heat Pump Control inputs / outputs

8.5.2.1. Relay output QX*

Line no.					Programming	Possible values
QX1	QX2	QX3	QX4	QX5		
5890	5891	5892	5894	5895	Relay output QX1, 2, 3, 4, 5	None Consumption circuit pump 1 Q15 Consumption circuit pump 2 Q15 Pool circuit pump Q19 Heating circuit 3 pump Q20 Alarm output K10 Timer programme 5 K13 Heating circuit 1 pump Q2 DHW pump/valve Q3 Stage 1 compressor K1 Raise gen. regulation K32 Heating circuit 2 pump Q6 Regulator dT 1 K21 Regulator dT 2 K22

The output settings assign the corresponding functions based on the selection. By default, relay QX1 is configured for remote fault reporting.

None

No function on the relay output.

Consumption circuit pump 1 Q15

Function not available.

Alarm output K10

If a fault occurs it is reported by the alarm relay. Contact closure has a two minute delay time. Once the error is eliminated, i.e. the error message is no longer present, the contact opens immediately.

Note: If the fault cannot be eliminated for now, the relay can still be reset. This is done from the *Faults* page.

Pump CC3 Q20

Function not available.

Consumption circuit pump 2 Q15

Function not available.

Pump CC1 Q2

Function not available.

Pump CC2 Q6

Function not available.

DHW pump/valve Q3

The relay controls the activation of the W3100 hydraulic station

Temp. change regulator 1 K21 / Temp. change regulator 1 K22

Relays K21 and K22 are used by the temperature change regulator dT.

Pool circuit pump Q19

Function not available.

Condenser pump Q9

Function not available.

* = restricted access level

Time programme 5 K13

The relay is controlled by the settings for timer programme 5.

Compressor stage 1 K1

The relay is used to control the first stage of the compressor.

This assignment can be used to notify the HP operation request to an external regulator (outside the defrosting cycle).

8.5.2.2. Sensor input BX*

BX1	Line no.		Programming	Possible values
	BX3	BX4		
5930	5932	5933	Sensor input BX1, 3, 4	None Pool sensor B13 Flow sensor common B10 Special temp. sensor 1 Special temp. sensor 2 Outdoor sensor B9 Room thermostat B5 Room thermostat B52 Room thermostat B53

The output settings assign the corresponding functions based on the selection.

None

No function on the sensor input.

External sensor B9

Function not available.

B10 line output sensor

This sensor is required for the common flow line.

Pool sensor B13

Function not available.

Special temp. sensor 1

This sensor can be used for the temperature difference regulator general function.

Special temp. sensor 2

This sensor can be used for the temperature difference regulator general function.

Room thermostat B5

Function not available.

Room thermostat B52

Function not available.

Room thermostat B53

Function not available.

* = restricted access level

8.5.2.3. Inputs H1 / H3*

Line no.		Programming	Possible values
H1	H3		
5950	5960	Function input Hx	none switching of heating circuit + DHW operation switching of heating circuit modes switching of heating circuit 1 mode switching of heating circuit 2 mode HC3 rate switching error message / alarm message consump. circuit request 1 consump. circuit request 2 consump. circ. request 1 10V consump. circ. request 2 10V pressure measurement 10V generator release swimming pool DHW temperature level HC1 temperature level HC2 temperature level HC3 temperature level Room thermostat HC1 Room Thermostat 2 Room thermostat 3 Room measurement 10V

DHW rate switching

This function is active at input H1.

Error/alarm message

This function is active at input H3.

The input causes a regulator error message. If the alarm output is configured accordingly (relay outputs QX4, line 584), then the error is forwarded or displayed by an additional contact (e.g. an outside indicator or buzzer).

Line no.		Programming	Possible values
H1	H3		
5951	5961	Contact action direction	none HC+DHW rate switching normally closed contact operation contact

Normally-closed contact (H3)

The contact is normally closed and must be opened to enable the chosen function

Operation contact (H1)

The contact is normally open and must be closed to enable the chosen function.

Parameter <i>Hx contact action direction</i>	Contact status on terminal Hx	Function status / action
Operation contact	open	inactive
	closed	active
Normally-closed contact (NC)	open	active
	closed	inactive



WARNING:

In order to preserve the proper functioning of the product, the functions and directions of action of contacts H1 and H3 must not be modified under any circumstances

* = restricted access level

8.5.2.4. Register sensor*

If faulty sensors are detected after installation and to avoid integrating them with correct status (which may occur if automatic detection is used), there is a Commissioning function.

This function learns to recognise the connected sensors and, if a fault occurs, generates an error message while inhibiting any installation diagram change.

Line no.	Programming	Possible values
6200	Register sensor	no yes

At midnight, the standard device records the status of the sensor terminals, so long as the regulator has already been running for at least two hours. If a sensor fails after registration, then the standard device generates an error message. This setting is used to immediately register the sensors. This may be necessary, e.g. when a sensor is removed and is no longer of any use.

Line no.	Programming	Possible values
6205	Reset parameters	no yes

All of the parameters can be reset to the factory settings except for the following pages:

- Time and date
- User interface
- Radio and all time programmes, and
- And the manual rate setpoint.

8.6. "LPB system" parameters

To communicate with other regulators, OCI 345 offers an LPB bus.

This accessory screws onto the heat pump controller unit.

The LPB bus allows the Ecomod Heat Pump Control regulation to create HP cascades.

* = restricted access level

8.6.1. LPB address*

Line no.	Programming	Possible values
6600	Appliance address	0 ... 16
6601	Segment address	0 ... 14

The device address identifies every device on the bus, in a similar way to a postal address. Every device must have a correct address to ensure communication. **Prefer segment 0 for generators.**

8.6.2. System messages*

Line no.	Programming	Possible values
6612	Alarm timeout	0 ... 60 min

Timeout between when the fault appears and when the output set as the "K10 alarm output" is triggered.

This time also acts when sending the fault condition for a slave heat pump to the master heat pump.

8.6.3. Clock*

Line no.	Programming	Possible values
6640	Clock operation	Independent Slave without adjustment Slave with adjustment Master

This setting determines the action of the system time on the time set in the regulator.

Independent

The time can be set on the regulator. The regulator time is not synchronised with system time.

Slave without adjustment

The time cannot be set on the regulator. The regulator time is automatically synchronised with system time all of the time.

Slave with adjustment

The time can be set on the regulator. It is simultaneously taken as the system time by the master. The regulator time is however automatically and constantly adapted to match system.

Master

The time can be set on the regulator. The regulator time becomes the reference time for the system. System time is synchronised.

* = *restricted access level*

8.7. "Error" parameters

As soon as an error occurs, an error message can be seen at the Info level via the Info button. The display shows the cause of the error.

The heat pump controller records the last ten faults. The system stores the fault code and the time when the fault occurred.

8.7.1. Error in progress

Line no.	Programming	Possible values
6700	In progress ...	00:00 ... 23:59 h:m

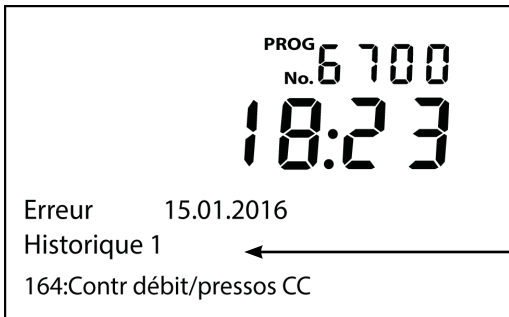

Time when the fault appeared

Date when the fault appeared

History log number

Error code and details of the fault

8.7.2. History

Line no.	Programming	Possible values
6800, 6802, 6804, 6806, 6808, 6810, 6812, 6814, 6816, 6818	History ...	00:00 ... 23:59 h:m

The unit stores the last ten errors that occurred in non volatile memory. A new entry clears the oldest entry from the memory. For every error input, the system records the code and the time.

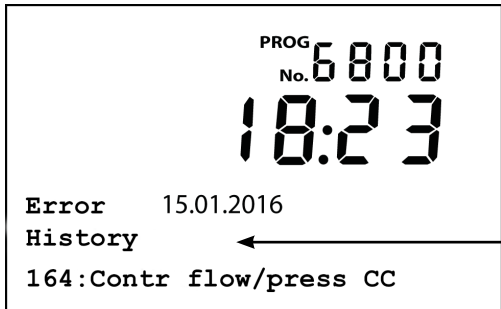

Time when the fault appeared

Date when the fault appeared

History log number

Error code and details of the fault

8.8. "Maintenance/Special operation" parameters

8.8.1. Maintenance function

Line no.	Programming
7070	Heat pump interval
7071	Time since heat pump maintenance
7072	Max starts compr 1/hrs run
7073	Cur starts compr 1/hrs run

Heat pump interval Sets the interval (in months) between heat pump servicing.

Time since Displays the period of time (in months) since the last service check.
If the value is over the "Heat pump interval" setting.

Heat pump maintenance - The  symbol is displayed, and
- A maintenance message is provided at the info level: 17 : HP interval (priority 6).

8.8.2. Maximum number of heat pump start up requests per hour of operation

Max starts Compr1 /hour Maximum number of heat pump compressor start up requests per hour of operation

Counter Starts compr1 / hour Average number of heat pump start up requests per hour of operation reached during the last six weeks If the value is over the "Max starts Compr1 /hour" setting.

- The  symbol is displayed, and
- A maintenance message is provided at the info level: 8: Too many compressor 1 starts (priority 9).

* = *restricted access level*

8.8.3. Commissioning*

Line no.	Programming	Possible values
7202	Heat pump commissioning	Off Heating Cooling
7207	Select heat pump power modulation	
7214	Test funct. mode	

Commissioning the heat pump

The commissioning function allows the Ecomod heat pump to operate in line with consumer requirements. Setting 7202 determines the operating mode.

CAUTION: Only "heating" mode is allowed on Ecomod heat pumps.

The heat pump however only comes on if the power selection (7207) has been made.

The commissioning function ends if a power break occurs (7202 = Off).

The compressor does not come back on automatically if the heat pump reaches a safety limit value during the active commissioning process. In this case, the output selection is reset (7207 = 0%), but the commissioning function itself (7202 = heating for example) remains active.

The commissioning function automatically switches off after two hours with no manual changes made to the 7202 parameter settings.

The 7207 parameters are reset to the default values after manually aborting or disabling the commissioning function.

The parameters need to be re-entered to restart the commissioning function.

Select heat pump power modulation

This setting defines the power (0...100%) of a modulating heat pump during the active commissioning sequence. The heat pump will operate at a set power level during the active commissioning sequence.

* = restricted access level

8.9. "Inputs/outputs test" parameters

The inputs/outputs test is used to ensure that the connected components operate properly.



CAUTION:

The selected sensor values are updated with a maximum of 5 seconds. The display does not take into account any corrections to the measured values.



INFORMATION:

The relay test can be activated via diagnostics software and via the operating interface. It remains active for a maximum of eight minutes after which time it is forced to shut down.

8.9.1. Relay output test*

Line no.	Programming	Possible values
7700	Relay test	No test All stopped Relay output QX1 Relay output QX2 Relay output QX3 Relay output QX4 Relay output Q5 Relay output QX21 module 1 Relay output QX22 module 1 Relay output QX23 module 1 Relay output QX21 module 2 Relay output QX22 module 2 Relay output QX23 module 2 Relay output QX21 module 3 Relay output QX22 module 3 Relay output QX23 module 3

The relay test allows enabling or disabling all of the relay outputs (burner, pumps, etc.) regardless of regulator status. This is used to quickly check the wiring.

A parameter dedicated to this purpose allows triggering each relay individually. The set state remains active after exiting this parameter.

The test can be stopped explicitly, else it automatically disables itself after one hour.

No test

The output test is disabled.

Everything is on STOP

All of the outputs are disabled.

Relay output QX...

Only QX... is set.

Relay output QX2... module n

Only QX2... on extension module n is enabled.

* = restricted access level

8.9.2. Sensor input test

Line no.	Programming	Possible values
7804	Sensor T° BX1	-28 ... 350°C
7806	Sensor T° BX3	-28 ... 350°C
7807	Sensor T° BX4	-28 ... 350°C

The input test is used to read the current measurement values from the device input terminals. This is used to quickly check the wiring.

8.9.3. Test of inputs H1 / H2 / H3*

Line no.	Programming	Possible values
7840	H1 voltage signal	0 ... 10 V
7841	H1 contact status	Open Closed
7845	Module 1 H2 voltage signal	0 ... 10 V
7846	Module 1 H2 contact status	Open Closed
7848	Module 2 H2 voltage signal	0 ... 10 V
7849	Module 2 H2 contact status	Open Closed
7851	Module 3 H2 voltage signal	0 ... 10 V
7852	Module 3 H2 contact status	Open Closed
7854	H3 voltage signal	0 ... 10 V
7855	H3 contact status	Open Closed

The input test is used to read the current measurement values from the device input terminals. This is used to quickly check the wiring.

* = restricted access level

8.10. "Status" parameters

The current operating state of the installation is viewed using the status displays.

Line no.	Programming
8003	DHW status

Final user (info level)	Commissioning, specialist	Status No.
Active manual intervention.	Active manual intervention.	4
Fluid decanting regime	Fluid decanting regime	199
Heat maintenance mode EN	Heat maintenance mode active	222
	Heat maintenance mode EN	221
Load locking active.	Discharge protection active	79
	Load duration limit active	80
	Load locked	81
		82
Forced load active	Forcing, maximum temperature of the tank	83
	Forcing, maximum temperature of load	84
	Forcing, anti-Legionella setpoint	85
	Forcing, comfort setpoint	86
		67
Accelerated load active	Active start	92
		94
	Load, Comfort setpoint	96
	Load, reduced setpoint	97
Activated load		69
Antifreeze protection enabled	Antifreeze protection enabled	24
	Antifreeze protection of water heater snapshot	223
Delayed power-cut response active.	Delayed power-cut response active.	17
Load on standby	Load on standby	201
Under load	Under load, maximum temperature of the tank	70
	Under load, maximum temperature of load	71
	Under load, comfort temperature	99
	Under load, reduced temperature	100
		75
Stop	Stop	25
Ready	Ready	200

Line no.	Programming
8006	HP status

Final user (info level)	Commissioning, specialist	Status No.
Fault.	Fault.	2
Locked	Limit outdoor min. temp	187
	Limit outdoor max. temp	188
		10
Time limit active	Limit compressor hot gas	32
	Limit max. stop temperature	34
	Limit min. stop temperature	139
	Minimum active compr. stop time	35
		37
Heating mode	Maximum active compr. stop time	38
	Compressor EN	46
		137
Compressor locked	Locked, max. return temperature	261
	Locked, min. return temperature	262
	Locked, max. flow temperature	263
	Locked, min. flow temperature	264
	Locked, max. hot gas temperature	267
		258
Frost protection activated	Frost protection installation activated	23
		24
Stop	Active start	49
	Stop timer activated	17
	Released, evaporator ready	50
	No request	51
		25

8.11. "Diagnostics" parameters

8.11.1. Cascade diagnostics

Various setpoints and true values, relay switching states and generator states may be displayed for diagnostics purposes.

Line no.	Programming	Possible values
8100, 8102, 8104, 8106, 8108, 8110, 8112, 8114, 8116, 8118, 8120, 8122, 8124, 8126, 8128, 8130	Generator priority	0 ... 16
8101, 8103, 8105, 8107, 8109, 8111, 8113, 8115, 8117, 8119, 8121, 8123, 8125, 8127, 8129, 8131	Generator state	Missing Failed Man. setting active Locked Heat pump active Sweeping funct. active DHW separation activated Out. Temp. limitation active Not released Released
8138	Cascade starting temperature	0 ... 140°C
8139	Cascade starting setpoint	0 ... 140°C
8140	Cascade return temperature	0 ... 140°C
8150	Current generator cascade switch	0 ... 990 h

8.11.2. Generator diagnostics

Various setpoints and true values, relay switching states and generator states may be displayed for diagnostics purposes.

Line no.	Programming	Possible values
8400	Compressor 1	ON OFF
8410	Heat pump return temperature	0 ... 140°C
8411	HP flow T° setpoint	0 ... 140°C
8412	HP flow temperature	0 ... 140°C
8413	Compressor modulation	0 ... 100%
8415	Hot gas temperature	0 ... 140°C
8434	Suction temperature	0 ... 140°C
8450	Compressor hours of operation	0 ... 199,999 h
8451	Compressor start counter	0 ... 199999
8585	Line start temperature	0 ... 140°C

8.11.3. Modbus slave diagnostics

The information below is used to troubleshoot the Ecomod heat pump via the signals exchanged over the Ecomod Heat Pump Control / Ecomod communication network

Line no.	HMI text	Related functions	Possible values
7611	UX signal input port 1	Compressor modulation	0 ... 100 (Hz)
7621	UX signal input port 2	Fan modulation	0 ... 100 (%)
7631	UX signal input port 3	Circulation pump modulation	0 ... 100 (%)

8.11.4. Consumer diagnostics

Various setpoints and true values, relay switching states and timer states may be displayed for diagnostics purposes.

Line no.	Programming	Possible values
8700	Outdoor temperature	-50 ... 50°C
8701	Minimum outdoor temperature	-50 ... 50°C
	Reset the min. outdoor temperature	
8702	Maximum outdoor temperature	-50 ... 50°C
	Reset the max. outdoor temperature	
8703	Attenuated outdoor temperature	-50 ... 50°C
	Reset the attenuated temperature	
8704	Mixed outdoor temperature	-50 ... 50°C
8820	DHW pump	off on
8830	DHW temperature 1 (B3)	0 ... 140 °C
8831	DHW setpoint	8 ... 80 °C
8832	DHW temperature 2 (B31)	0 ... 140 °C
8840	Number of DHW pump hours	0 ... 8333:7:00h
8841	DHW pump starts counter	0 ... 199999
8950	Line start temperature	0 ... 140°C
8951	Line start setpoint temperature	0 ... 140°C
9016	Special temperature 1	0 ... 140°C
9017	Special temperature 2	0 ... 140°C
9031	Relay output QX1	Open Closed
9032	Relay output QX2	Open Closed
9033	Relay output QX3	Open Closed
9034	Relay output QX4	Open Closed
9035	Relay output QX5	Open Closed

* HP pressure

9. HYDRAULIC DIAGRAMS AND CONFIGURATIONS



CAUTION:

Managing the primary circuit flow rate is essential to ensure product performance and service life. The flow setting value must be adapted to suit the application. Refer to the sizing study.

It is essential to install regulator valves (not supplied) on the decoupling tank return and on the return from every heat pump if a cascade installation is used.

When a cascade installation is used, the flow must be balanced between all units. We recommend performing this balancing using balancing valves so that individual flow levels can be measured over time.



CAUTION:

Flow adjustment and checking are the responsibility of the installer/operator and will not be performed by Ideal. When the system is commissioned, a balance check will be required by Ideal. If no check is performed, commissioning will be refused.

9.1. Symbols used in the diagrams

Symbol	Function
	Isolation valve open
	2-channel powered valve
	Pump
	Temperature sensor
	Sieve filter
	Cut-off valve with bleed tap

Symbol	Function
	Balancing valve
	Safety mixing valve
	Outdoor sensor
	No return valve
	Safety valve

9.2. List of diagrams

HEAT PUMP ONLY WITH ONE PRE-HEATING TANK	55
<i>1 decoupling bottle or tank, 1 DHW pre-heating tank</i>	
HEAT PUMP ONLY WITH TWO PRE-HEATING TANKS	60
<i>2 or 3 DHW preheating tanks</i>	
2 OR 3 HEAT PUMPS CASCADE WITH ONE PRE-HEATING TANK.....	65
<i>1 decoupling bottle or tank, 1 DHW pre-heating tank</i>	
2 HEAT PUMPS CASCADE WITH 2 OR 3 PRE-HEATING TANKS	71
<i>1 decoupling tank, 2 or 3 DHW pre-heating tanks</i>	

HEAT PUMP ONLY WITH ONE PRE-HEATING TANK
 1 decoupling bottle or tank, 1 DHW pre-heating tank

Diagrams
 HYF110
 HYF111
 page 1 / 5

A. HYDRAULIC DIAGRAM

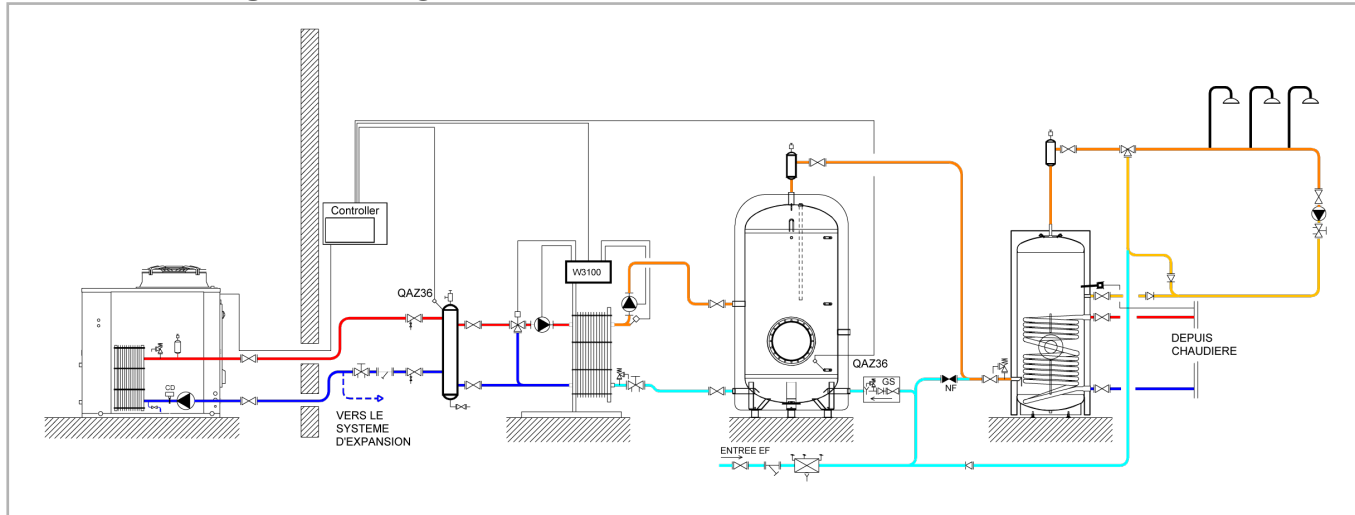

figure 16 - Diagram HYF110

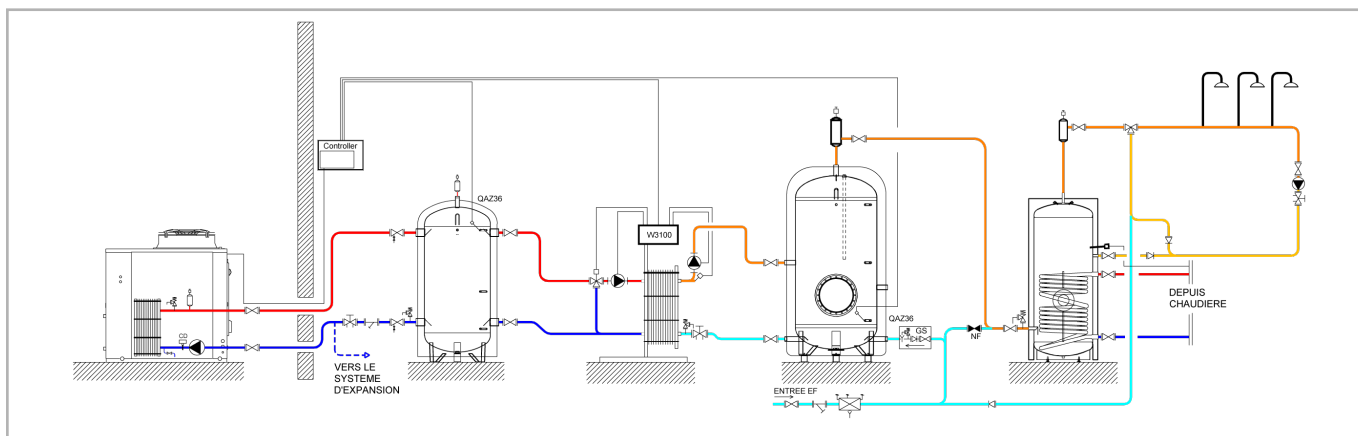

figure 17 - Diagram HYF111

B. REGULATION ACCESSORIES REQUIRED

	Quantity	Appliance reference	Order No.
Immersion sleeve sensor kit	2	QAZ 36	AH059261

C. DESCRIPTIONS

The HP supports DHW production during a time period with a configurable duration. Care will be taken to ensure that draw-offs are virtually non-existent during this time period.

The HP supports DHW production during a time period with a configurable duration. Care will be taken to ensure that draw-offs are virtually non-existent during this time period. This was defined during the sizing study.

If it is deemed necessary to implement anti-Legionella cycles on the downstream gas-heated tank, these will be covered by the gas generator. If anti-Legionella cycles are required on the preheating tank(s), the solution shown does not contain the hydraulic or electrical elements used to perform them. If this is to be expected, please contact our pre-sales department to choose the most suitable solution for your installation.

It should also be noted that the gas back-up is sized to fulfil all DHW requirements on its own. This is an additional safety mechanism with regard to extreme weather conditions that are not favourable to the HP's operation.

D. CUSTOMER'S ELECTRICAL CONNECTION

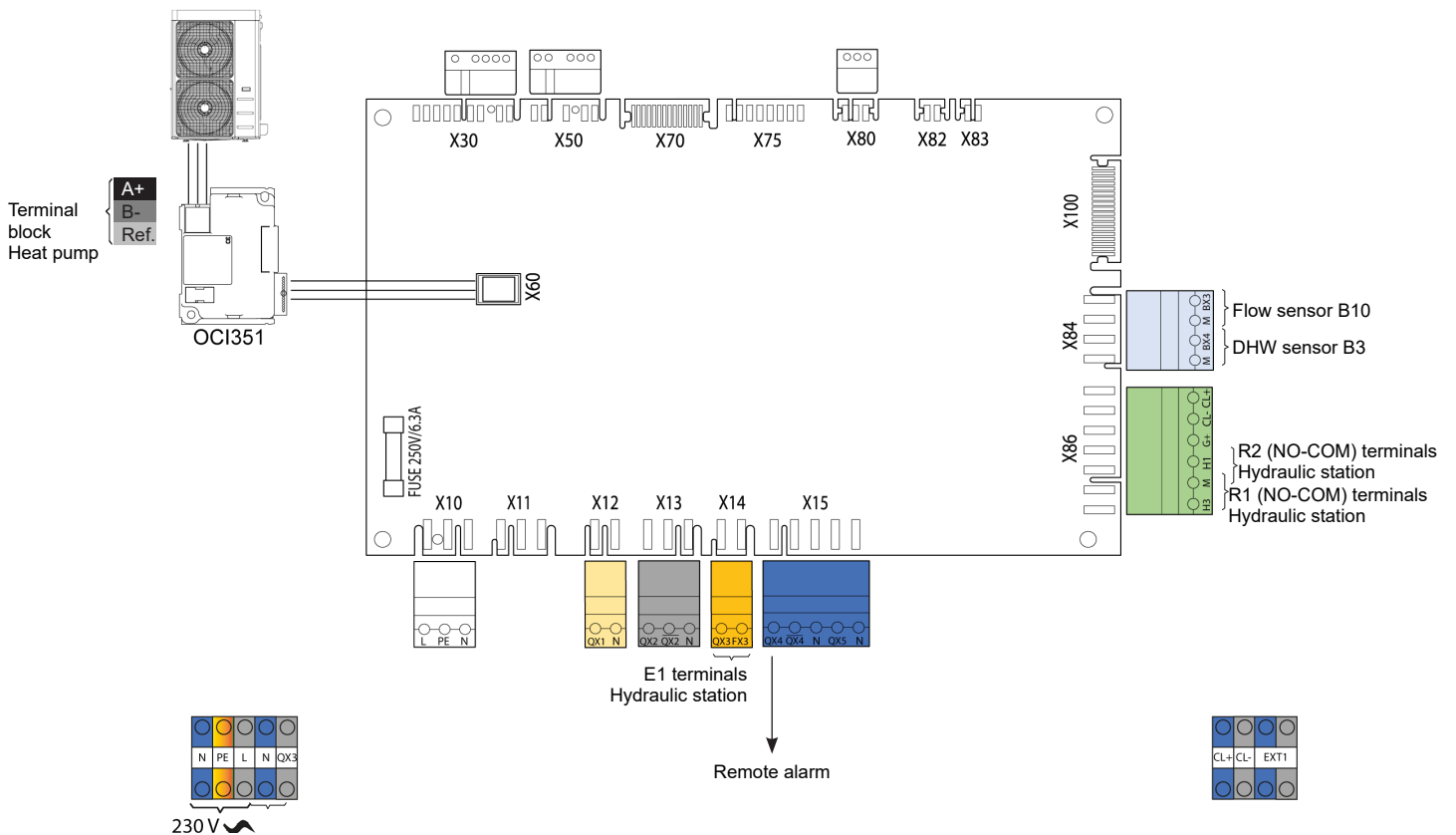

E. HYDRAULIC STATION

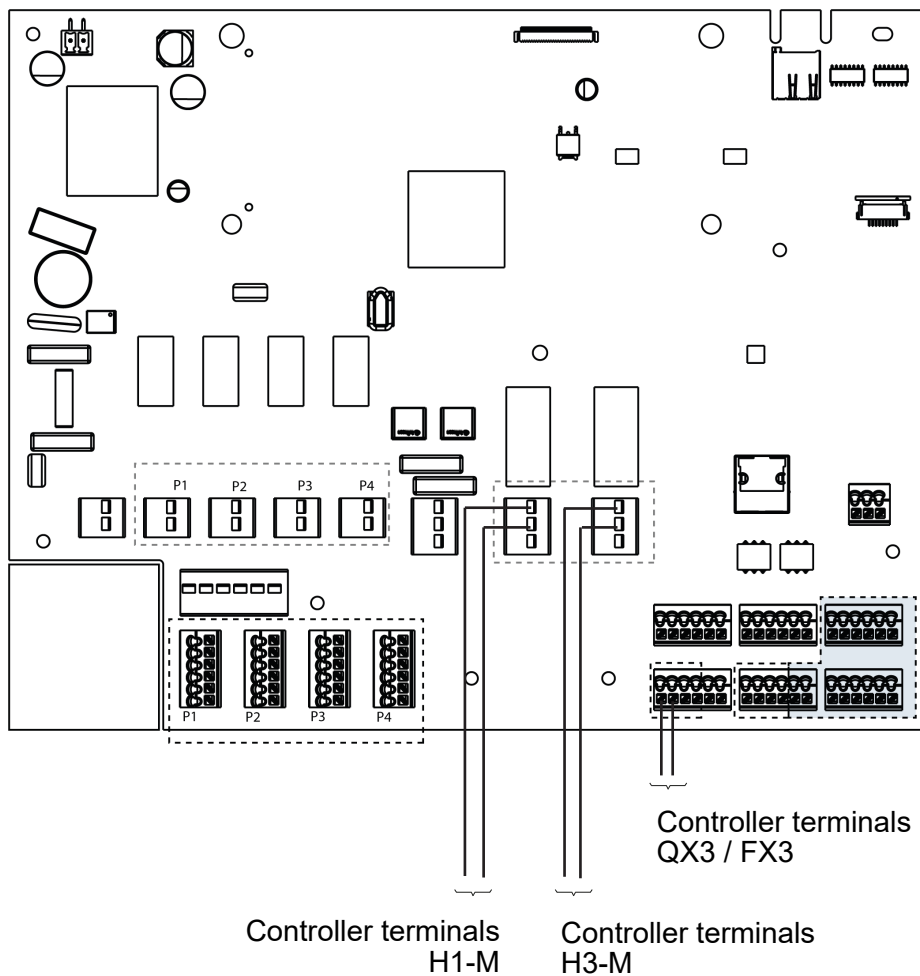

F. HYDRAULIC STATION PROGRAMMING

☞ Start up the hydraulic station



INFORMATION:

The hydraulic station arrives pre-programmed and requires no specific adjustment.

- *Settings / Equipment / Hydraulic diagram* menu
Check the application

Hydraulic configuration

HP application

G. SPECIFIC START-UP PROCEDURE

- ☞ Make the accessories' electrical connections.
- ☞ Start up the HP on its own.
- ☞ Perform the following settings in "Specialist" mode:



	Line No.	Value
• Time and date menu		
Set the time	Hour / minute (1)	HH.MM
Set the date	Day / month (2)	DD.MM
Set the year	Year (3)	YYYY
• Configuration menu		
Preset the model of heating heat pump	Preset (5700)	AHP60-14 or 60-18 = 5 AHP60-26 or 60-32 = 6 AHP60-50 = 7 AHP60-70 = 8
<i>Configure the hydraulic station output (preset)</i>	Relay output QX3 (5892)	DHW pump/valve Q3
<i>Configure the alarm output (preset)</i>	Relay output QX4 (5830)	Alarm output K10
<i>Assign the tank flow sensor (preset)</i>	Sensor input BX3 (5932)	B10 line output sensor
<i>Assign the DHW preheating sensor (preset)</i>	Sensor BX4 output (5933)	DHW source B3
<i>Configure the H1 input (preset)</i>	H1 input function (5950)	Switching of heating circuit + DHW operation
<i>Configure the contact direction (preset)</i>	Contact H1 action direction (5951)	Normally closed
<i>Configure the H3 input (preset)</i>	H3 input function (5960)	Error/alarm message
<i>Configure the contact direction (preset)</i>	Contact H3 action direction (5961)	Operation
<i>Configure mixer unit 1 (preset)</i>	Mixer unit 1 function (6014)	Multifunction
• DHW menu		
Adjust the comfort setting	Nominal setting (1610)	-- °C
• DHW Tank menu		

Diagrams: HYF110 - HYF111

page 5 / 5

	Line No.	Value
Set the DHW over-value (preset)	<i>Flow setpoint over-value</i> (5020)	5°C
• <i>Timer programme 4/DHW</i> menu		
Preselection	Preselection (560)	Monday-Sunday
Adjust the timer programming	1st phase ON (561)	00: 00 h
Adjust the timer programming	1st phase Off (562)	06: 00 h
Adjust the timer programming	2nd phase ON (563)	22: 00 h
Adjust the timer programming	2nd phase Off (564)	24: 00 h
• Switch the DHW rate to automatic		

H. HYDRAULIC VALIDATION

☞ Switch the power to the Ecomod back on:

It is necessary to adjust the flow rate of the HP taking the following characteristics into consideration

	AHP60-14	AHP60-18	AHP60-26	AHP60-32	AHP60-50	AHP60-70
Nominal flow rate (m ³ /h)	2.4	3.1	4.5	5.5	8.6	11.5

Refer to § 10 , page 81 for the regulator input/output tests.

HEAT PUMP ONLY WITH TWO PRE-HEATING TANKS
2 or 3 DHW preheating tanks

Diagrams
 HYF120
 page 1 / 5

A. HYDRAULIC DIAGRAM

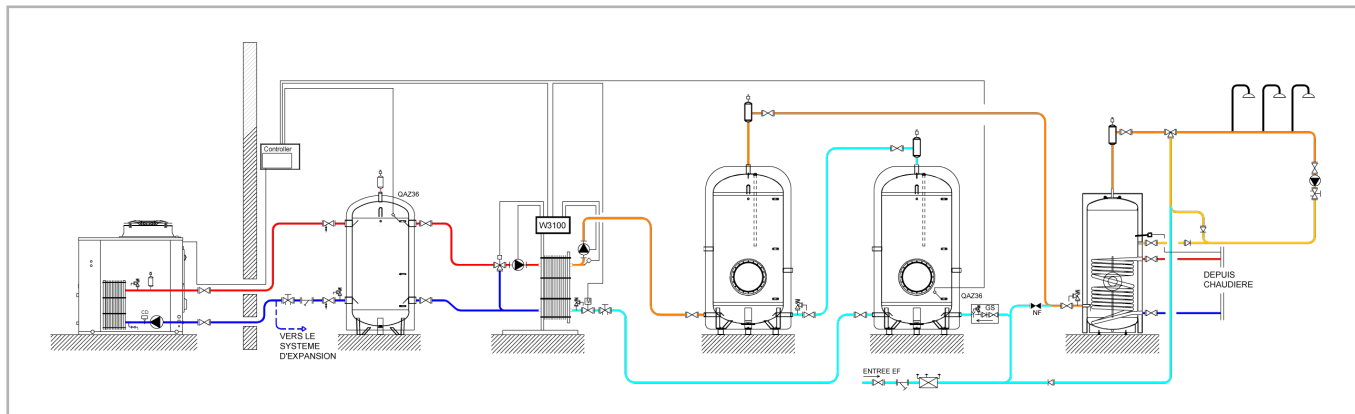

figure 18 - Diagram HYF120

B. REGULATION ACCESSORIES REQUIRED

	Quantity	Appliance reference	Order No.
Immersion sleeve sensor kit	2	QAZ 36	AH059261

C. DESCRIPTIONS

The HP supports DHW production during a time period with a configurable duration. Care will be taken to ensure that draw-offs are virtually non-existent during this time period.

The HP supports DHW production during a time period with a configurable duration. Care will be taken to ensure that draw-offs are virtually non-existent during this time period. This was defined during the sizing study.

If it is deemed necessary to implement anti-Legionella cycles on the downstream gas-heated tank, these will be covered by the gas generator. If anti-Legionella cycles are required on the preheating tank(s), the solution shown does not contain the hydraulic or electrical elements used to perform them. If this is to be expected, please contact our pre-sales department to choose the most suitable solution for your installation. It should also be noted that the gas back-up is sized to fulfil all DHW requirements on its own. This is an additional safety mechanism with regard to extreme weather conditions that are not favourable to the HP's operation.

Diagrams: HYF120

When 2 or more DHW preheating tanks are linked to the HP, it is necessary to add an isolation valve at the plate exchanger's secondary inlet in order to prevent cold water from being bypassed to the hot water tank during the drawing-off phases. This valve is supplied fitted and is controlled by the W3100.

D. CUSTOMER'S ELECTRICAL CONNECTION

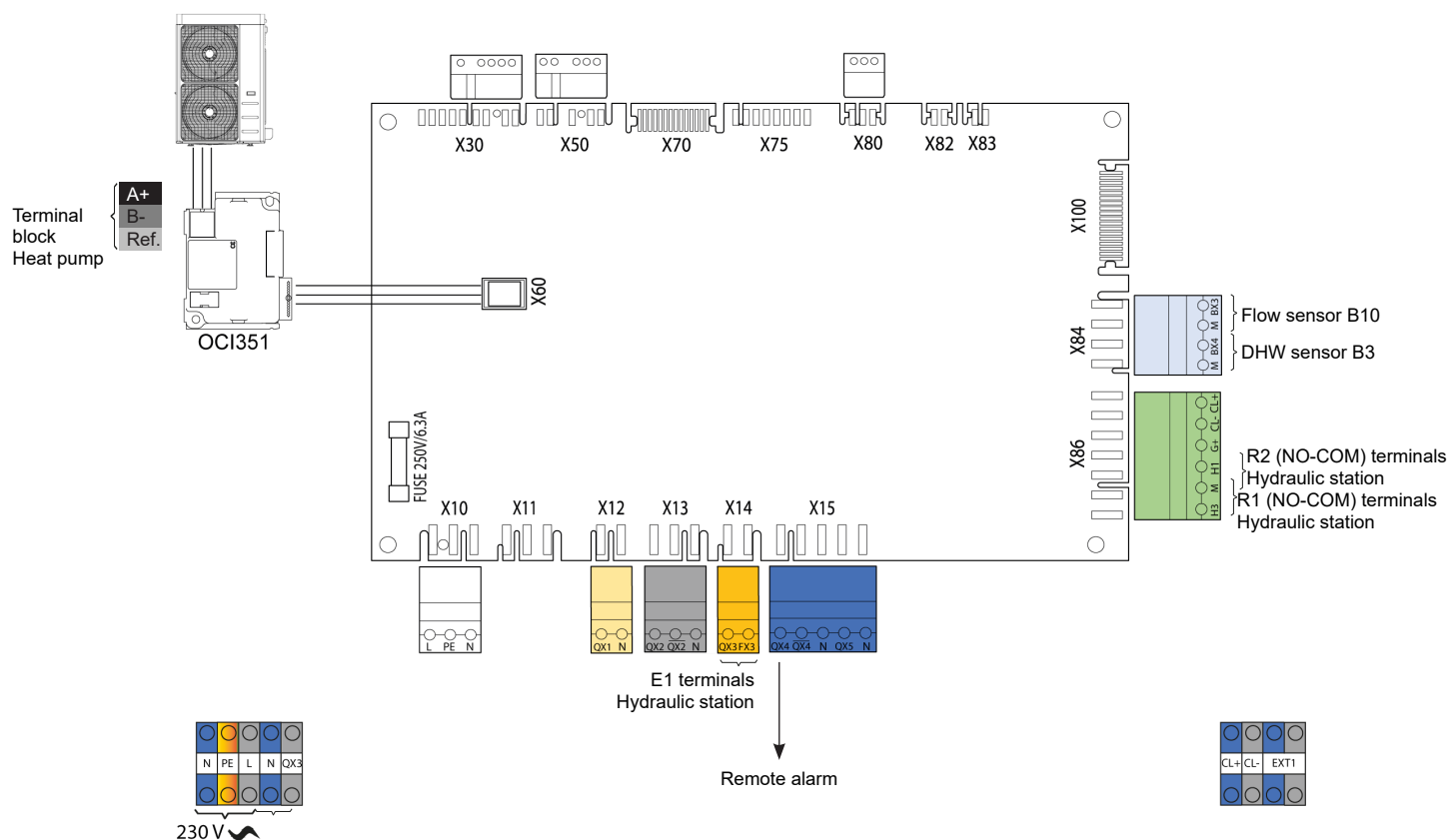

E. HYDRAULIC STATION

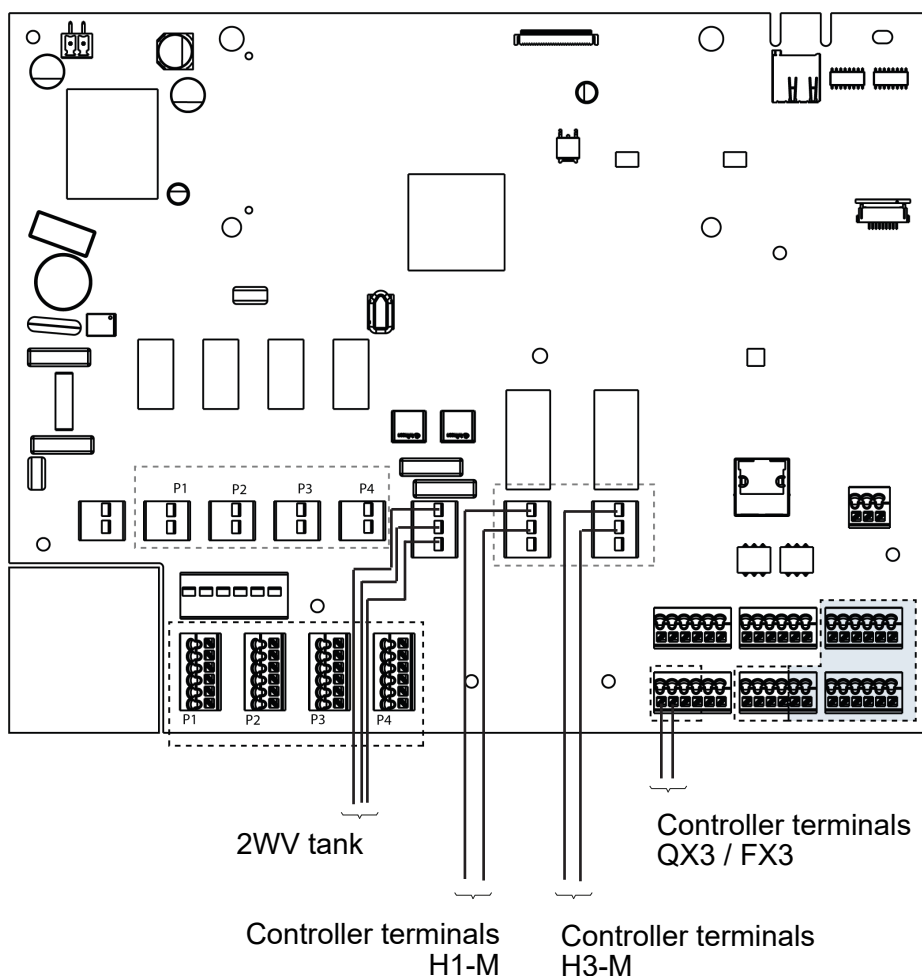

F. HYDRAULIC STATION PROGRAMMING

☞ Start up the hydraulic station



INFORMATION:

The hydraulic station arrives pre-programmed and requires no specific adjustment.

- *Settings / Equipment / Hydraulic diagram* menu
Check the application

Hydraulic configuration

HP application

G. SPECIFIC START-UP PROCEDURE

- ☞ Make the accessories' electrical connections.
- ☞ Start up the HP on its own and the hydraulic station.
- ☞ Perform the following settings in "Specialist" mode:

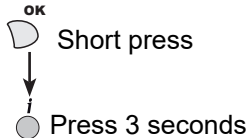

	Line No.	Value
• Time and date menu		
Set the time	Hour / minute (1)	HH.MM
Set the date	Day / month (2)	DD.MM
Set the year	Year (3)	YYYY
• Configuration menu		
Preset the model of heating heat pump	Preset (5700)	AHP60-14 or 60-18 = 5 AHP60-26 or 60-32 = 6 AHP60-50 = 7 AHP60-70 = 8
<i>Configure the hydraulic station output (pre-set)</i>	Relay output QX3 (5892)	DHW pump/valve Q3
<i>Configure the alarm output (preset)</i>	Relay output QX4 (5830)	Alarm output K10
<i>Assign the tank flow sensor (preset)</i>	Sensor input BX3 (5932)	B10 line output sensor
<i>Assign the DHW preheating sensor (pre-set)</i>	Sensor BX4 output (5933)	DHW source B3
<i>Configure the H1 input (preset)</i>	H1 input function (5950)	Switching of heating circuit + DHW operation
<i>Configure the contact direction (preset)</i>	Contact H1 action direction (5951)	Normally closed
<i>Configure the H3 input (preset)</i>	H3 input function (5960)	Error/alarm message
<i>Configure the contact direction (preset)</i>	Contact H3 action direction (5961)	Operation
<i>Configure mixer unit 1 (preset)</i>	Mixer unit 1 function (6014)	Multifunction
• DHW menu		
Adjust the comfort setting	Nominal setting (1610)	- - - °C
• DHW Tank menu		
Set the DHW over-value (preset)	Flow setpoint over-value (5020)	5 °C
• Timer programme 4/DHW menu		
Preselection	Preselection (560)	Monday-Sunday
Adjust the timer programming	1st phase ON (561)	00: 00 h
Adjust the timer programming	1st phase Off (562)	06: 00 h

Diagrams: HYF120

page 5 / 5

	Line No.	Value
Adjust the timer programming	2nd phase ON (563)	22: 00 h
Adjust the timer programming	2nd phase Off (564)	24: 00 h

- Switch the DHW rate to automatic

**H. HYDRAULIC VALIDATION**

☞ Switch the power to the Ecomod back on:

It is necessary to adjust the flow rate of the HP taking the following characteristics into consideration

	AHP60-14	AHP60-18	AHP60-26	AHP60-32	AHP60-50	AHP60-70
Nominal flow rate (m ³ /h)	2.4	3.1	4.5	5.5	8.6	11.5

Refer to § 10 , page 81 for the regulator input/output tests.

2 OR 3 HEAT PUMPS CASCADE WITH ONE PRE-HEATING TANK

1 decoupling bottle or tank, 1 DHW pre-heating tank

Diagrams
HYF210
page 1 / 6

A. HYDRAULIC DIAGRAMS

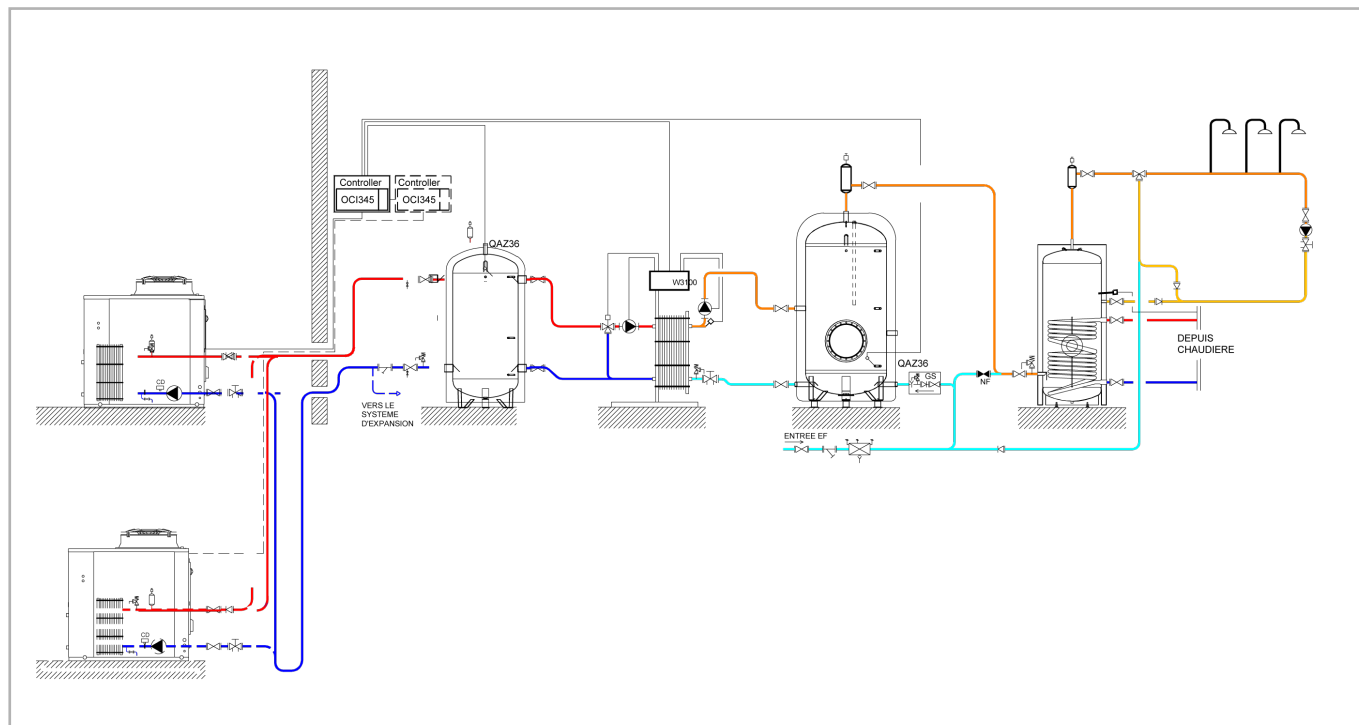

figure 19 - Diagram HYF210

B. REGULATION ACCESSORIES REQUIRED

	Quantity	Appliance reference	Order No.
OCI kit	1 per heat pump	OCI 345	AH059752
Immersion sleeve sensor kit	2	QAZ 36	AH059261

Diagrams: HYF210

Heat Pump No. 2:

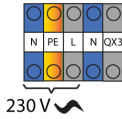
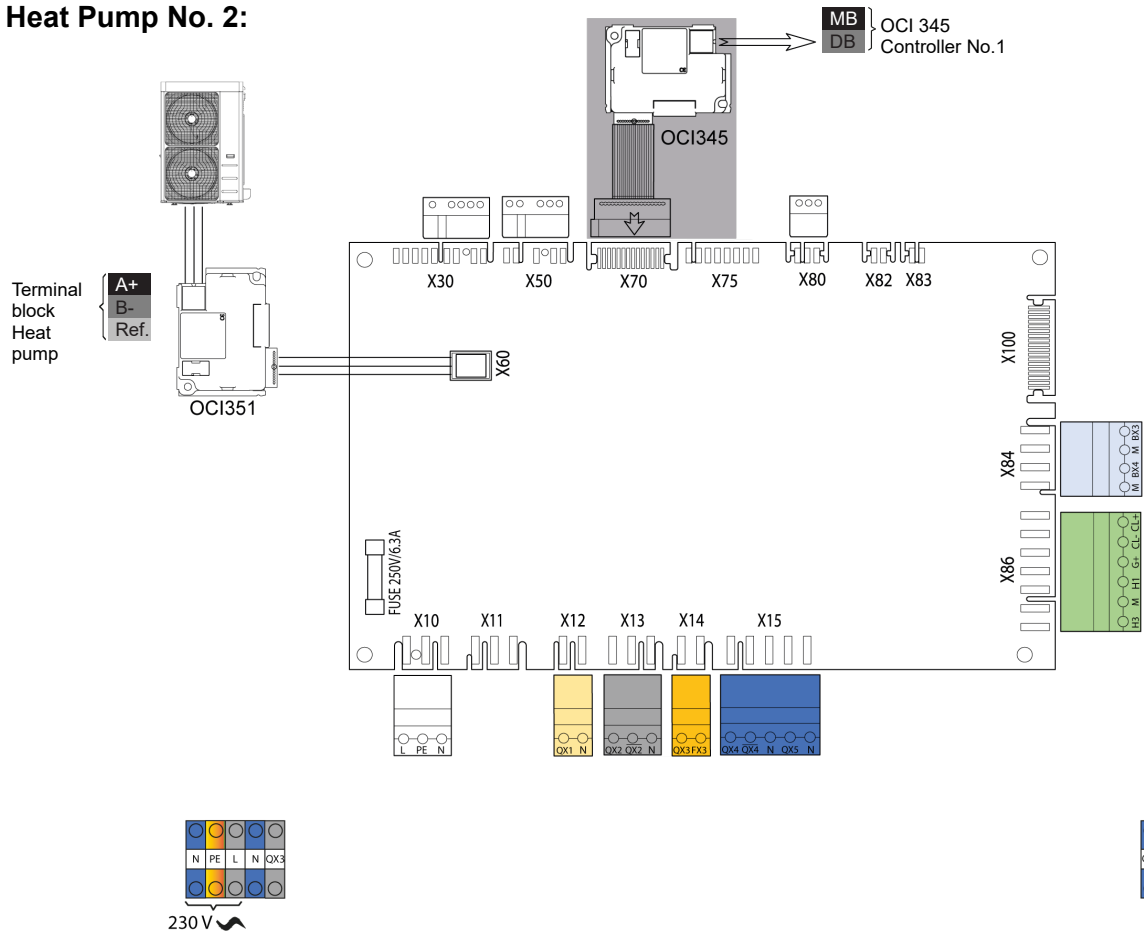

E. HYDRAULIC STATION

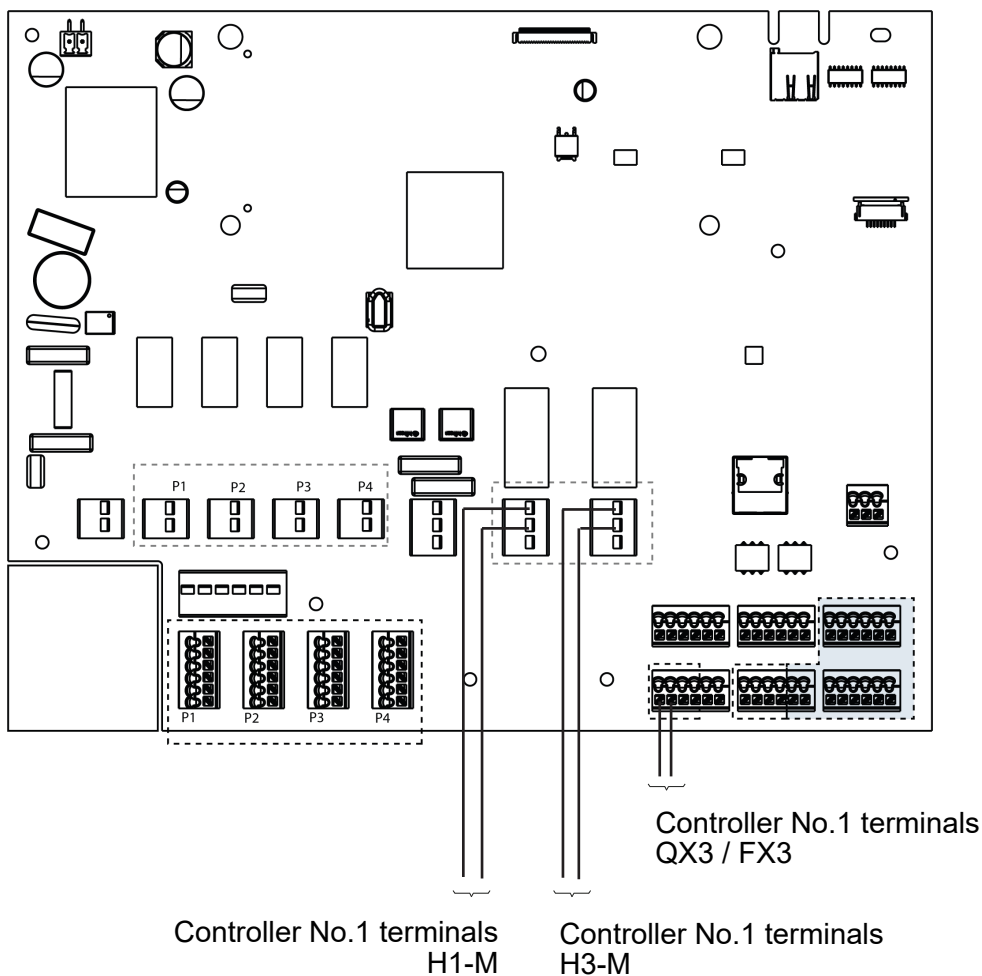

F. HYDRAULIC STATION PROGRAMMING

☞ Start up the hydraulic station

i

INFORMATION: The hydraulic station arrives pre-programmed and requires no specific adjustment.

- *Settings / Equipment / Hydraulic diagram* menu
Check the application

Hydraulic configuration	HP application
-------------------------	----------------

G. SPECIFIC START-UP PROCEDURE

- ☞ Make the accessories' electrical connections.
- ☞ Start up each HP.
- ☞ Perform the following settings in "Specialist" mode:



Heat Pump No. 1 Cascade master:

	Line No.	Value
• Time and date menu		
Set the time	Hour / minute (1)	HH.MM
Set the date	Day / month (2)	DD.MM
Set the year	Year (3)	YYYY
• Configuration menu		
Preset the model of heating heat pump	Preset (5700)	AHP60-14 or 60-18 = 5 AHP60-26 or 60-32 = 6 AHP60-50 = 7 AHP60-70 = 8
Configure the hydraulic station output (preset)	Relay output QX3 (5892)	DHW pump/valve Q3
Configure the alarm output (preset)	Relay output QX4 (5830)	Alarm output K10
Assign the tank flow sensor (preset)	Sensor input BX3 (5932)	B10 line output sensor
Assign the DHW preheating sensor (preset)	Sensor BX4 output (5933)	DHW source B3
Configure the H1 input (preset)	H1 input function (5950)	Switching of heating circuit + DHW operation
Configure the contact direction (preset)	Contact H1 action direction (5951)	Normally closed
Configure the H3 input (preset)	H3 input function (5960)	Error/alarm message
Configure the contact direction (preset)	Contact H3 action direction (5961)	Operation
Configure mixer unit 1 (preset)	Mixer unit 1 function (6014)	Multifunction
• DHW menu		
Adjust the comfort setting	Nominal setting (1610)	-- °C
• DHW Tank menu		
Set the DHW over-value (preset)	Flow setpoint over-value (5020)	5°C
• Timer programme 4/DHW menu		
Preselection	Preselection (560)	Monday-Sunday
Adjust the timer programming	1st phase ON (561)	00: 00 h
Adjust the timer programming	1st phase Off (562)	06: 00 h

	Line No.	Value
Adjust the timer programming	2nd phase ON (563)	22: 00 h
Adjust the timer programming	2nd phase Off (564)	24: 00 h
• LPB network menu		
Number of the appliance (preset)	Appliance address (6600)	1
Number of the segment (preset)	Segment address (6601)	0
Adjust the clock rate	Clock operation (6640)	Master
• Switch the DHW rate to automatic		



Heat Pump No. 2:

	Line No.	Value
• Configuration menu		
Preset the model of heating heat pump	Preset (5700)	AHP60-14 or 60-18 = 5 AHP60-26 or 60-32 = 6 AHP60-50 = 7 AHP60-70 = 8
• LPB network menu		
Number of the appliance	Appliance address (6600)	2
Number of the segment (preset)	Segment address (6601)	0
Adjust the clock rate (preset)	Clock operation (6640)	Slave without adjustment

H. HYDRAULIC VALIDATION

☞ Switch the power to the Ecomod back on:

It is necessary to adjust the flow rate of each HP taking the following characteristics into consideration:
Unit flow characteristics of each HP, when all HPs are in operation

	AHP60-14	AHP60-18	AHP60-26	AHP60-32	AHP60-50	AHP60-70
Nominal flow rate (m ³ /h)	2.4	3.1	4.5	5.5	8.6	11.5

Refer to § 10 , page 81 for the regulator input/output tests.

2 HEAT PUMPS CASCADE WITH 2 OR 3 PRE-HEATING TANKS

1 decoupling tank, 2 or 3 DHW pre-heating tanks

Diagrams
HYF220
HYF23a
page 1 / 6

A. HYDRAULIC DIAGRAMS

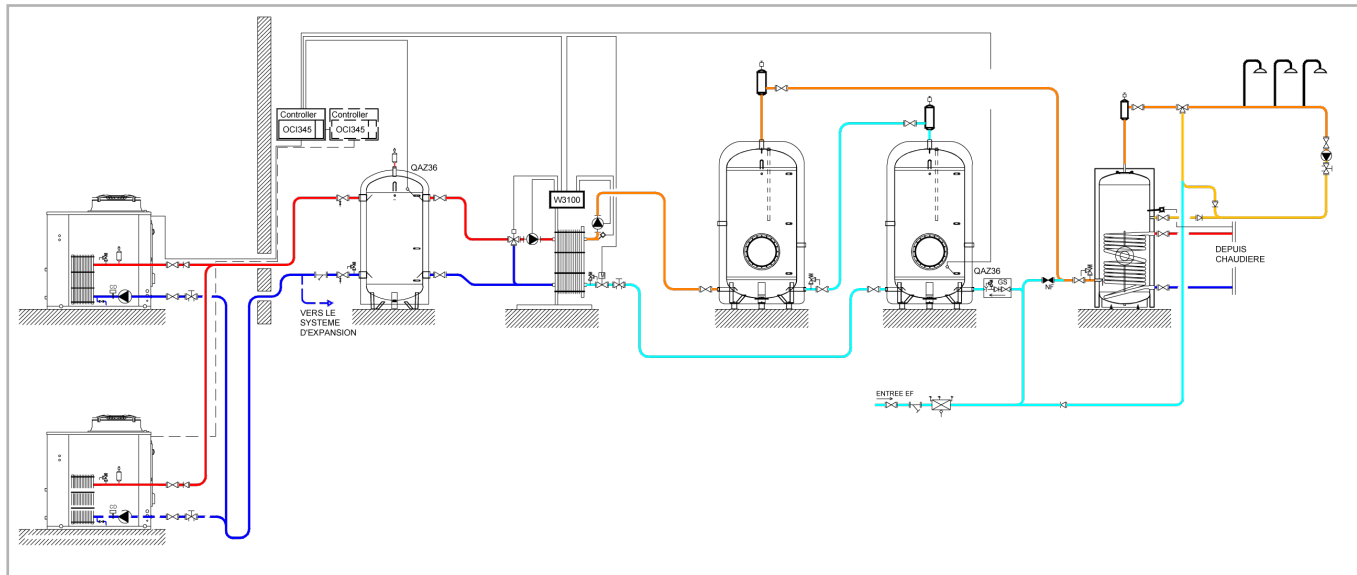

figure 21 - Diagram HYF220

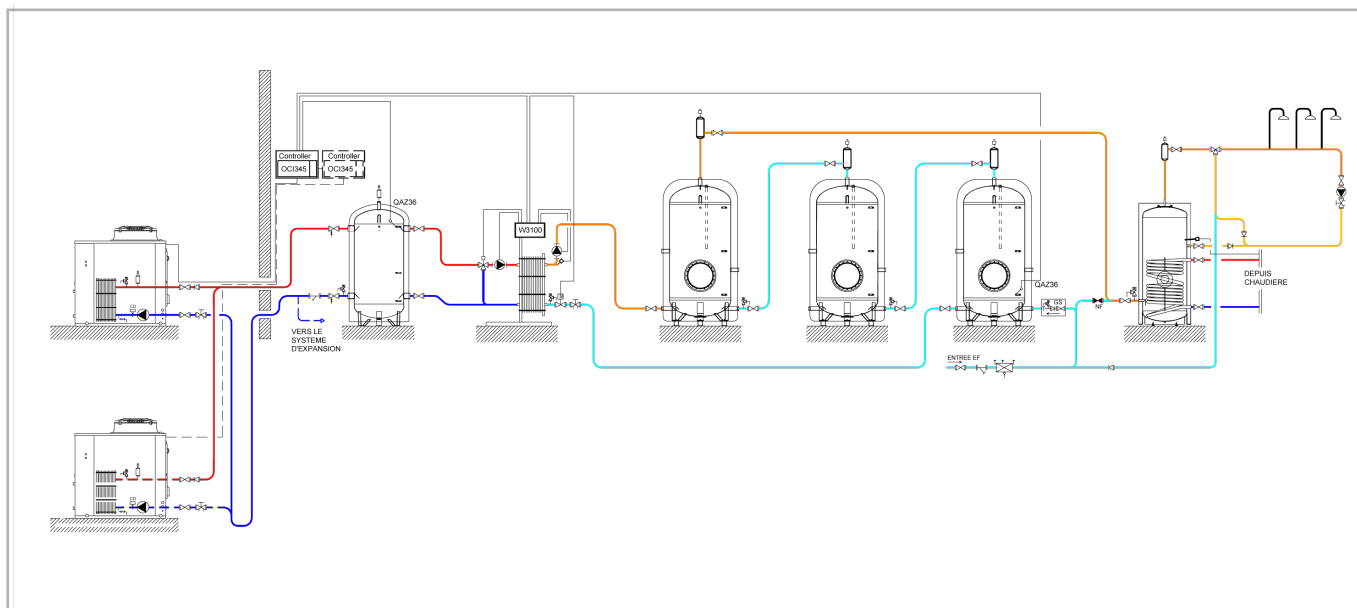

figure 20 - Diagram HYF23a

B. REGULATION ACCESSORIES REQUIRED

	Quantity	Appliance reference	Order No.
OCI kit	1 per heat pump	OCI 345	AH059752
Immersion sleeve sensor kit	2	QAZ 36	AH059261

C. FUNCTIONAL EXPLANATIONS

The HP supports DHW production during a time period with a configurable duration. Care will be taken to ensure that draw-offs are virtually non-existent during this time period.

The HP supports DHW production during a time period with a configurable duration. Care will be taken to ensure that draw-offs are virtually non-existent during this time period. This was defined during the sizing study.

If it is deemed necessary to implement anti-Legionella cycles on the downstream gas-heated tank, these will be covered by the gas generator. If anti-Legionella cycles are required on the preheating tank(s), the solution shown does not contain the hydraulic or electrical elements used to perform them. If this is to be expected, please contact our pre-sales department to choose the most suitable solution for your installation.

It should also be noted that the gas back-up is sized to fulfil all DHW requirements on its own. This is an additional safety mechanism with regard to extreme weather conditions that are not favourable to the HP's operation.

When 2 or more decoupling tanks are linked to the HP, it is necessary to add an isolation valve at the plate exchanger's secondary inlet in order to prevent cold water from being bypassed to the hot water tank during the drawing-off phases. This valve is supplied fitted and the exchanger is controlled by the W3100.

The implementation of a cascade of several HPs requires the addition of OCI345 back-up modules (one per HP) to ensure communication between HPs and the proper functioning of the cascade algorithm.

D. CUSTOMER'S ELECTRICAL CONNECTION

Ecomod Heat Pump Control Master No.1

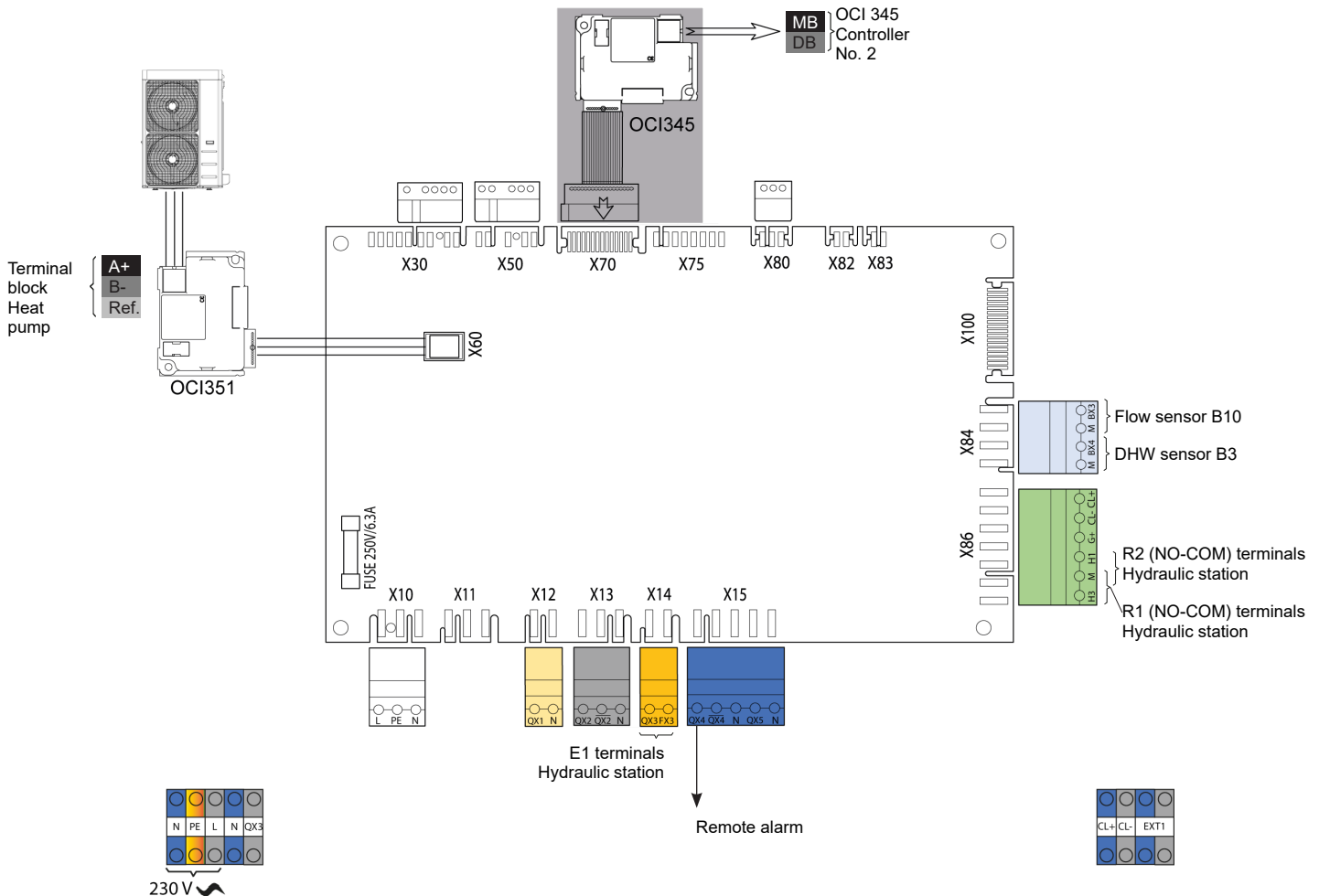

Diagrams: HYF220, HYF23a

Heat Pump No. 2:

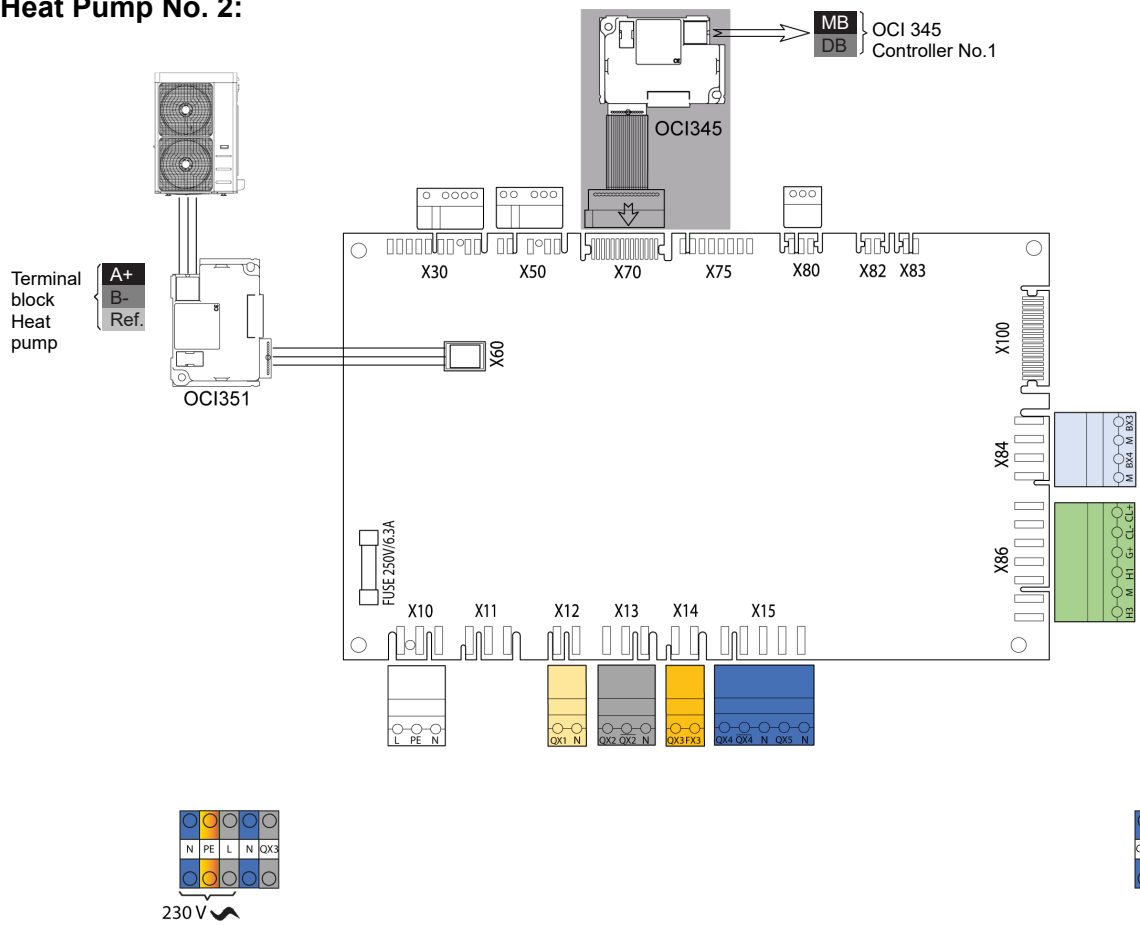

E. HYDRAULIC STATION

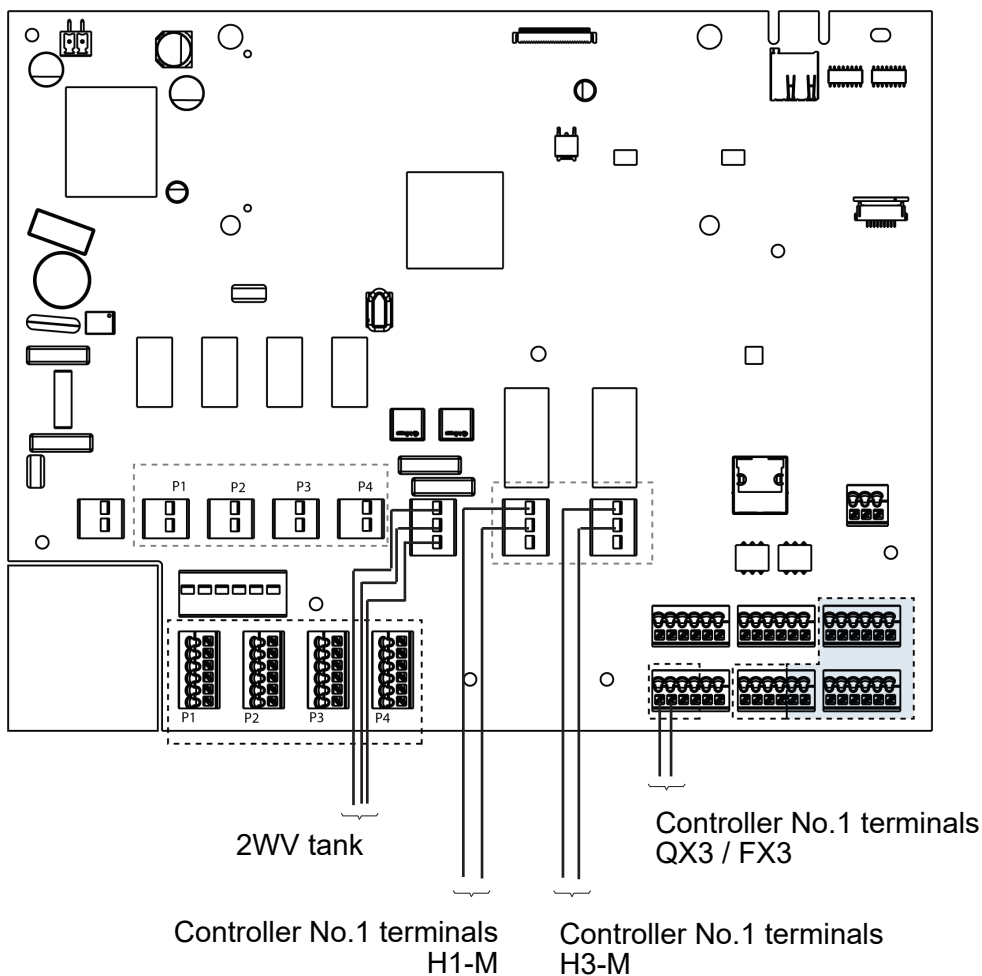

F. HYDRAULIC STATION PROGRAMMING

☞ Start up the hydraulic station

INFORMATION: The hydraulic station arrives pre-programmed and requires no specific adjustment.

- *Settings / Equipment / Hydraulic diagram* menu
Check the application

Hydraulic configuration	HP application
-------------------------	----------------

G. SPECIFIC START-UP PROCEDURE

- ☞ Make the accessories' electrical connections.
- ☞ Start up each HP.
- ☞ Perform the following settings in "Specialist" mode:



Heat Pump No. 1 Cascade master:

	<i>Line No.</i>	<i>Value</i>
• Time and date menu		
Set the time	Hour / minute (1)	HH.MM
Set the date	Day / month (2)	DD.MM
Set the year	Year (3)	YYYY
• Configuration menu		
Preset the model of heating heat pump	Preset (5700)	AHP60-14 or 60-18 = 5 AHP60-26 or 60-32 = 6 AHP60-50 = 7 AHP60-70 = 8
Configure the hydraulic station output (preset)	Relay output QX3 (5892)	DHW pump/valve Q3
Configure the alarm output (preset)	Relay output QX4 (5830)	Alarm output K10
Assign the tank flow sensor (preset)	Sensor input BX3 (5932)	B10 line output sensor
Assign the DHW preheating sensor (preset)	Sensor BX4 output (5933)	DHW source B3
Configure the H1 input (preset)	H1 input function (5950)	Switching of heating circuit + DHW operation
Configure the contact direction (preset)	Contact H1 action direction (5951)	Normally closed
Configure the H3 input (preset)	H3 input function (5960)	Error/alarm message
Configure the contact direction (preset)	Contact H3 action direction (5961)	Operation
Configure mixer unit 1 (preset)	Mixer unit 1 function (6014)	Multifunction
• DHW menu		
Adjust the comfort setting	Nominal setting (1610)	---°C
• DHW Tank menu		
Set the DHW over-value (preset)	Flow setpoint over-value (5020)	5°C

Diagrams: HYF220, HYF23a

	Line No.	Value
• Timer programme 4/DHW menu		
Preselection	Preselection (560)	Monday-Sunday
Adjust the timer programming	1st phase ON (561)	00: 00 h
Adjust the timer programming	1st phase Off (562)	06: 00 h
Adjust the timer programming	2nd phase ON (563)	22: 00 h
Adjust the timer programming	2nd phase Off (564)	24: 00 h
• LPB network menu		
Number of the appliance (preset)	Appliance address (6600)	1
Number of the segment (preset)	Segment address (6601)	0
Adjust the clock rate	Clock operation (6640)	Master

- Switch the DHW rate to automatic



Heat Pump No. 2:

	Line No.	Value
• Configuration menu		
Preset the model of heating heat pump	Preset (5700)	AHP60-14 or 60-18 = 5 AHP60-26 or 60-32 = 6 AHP60-50 = 7 AHP60-70 = 8
• LPB network menu		
Number of the appliance	Appliance address (6600)	2
Number of the segment (preset)	Segment address (6601)	0
Adjust the clock rate (preset)	Clock operation (6640)	Slave without adjustment

H. HYDRAULIC VALIDATION

☞ Switch the power to the Ecomod back on:

It is necessary to adjust the flow rate of each HP taking the following characteristics into consideration:
Unit flow characteristics of each HP, when all HPs are in operation

	AHP60-14	AHP60-18	AHP60-26	AHP60-32	AHP60-50	AHP60-70
Nominal flow rate (m³/h)	2.4	3.1	4.5	5.5	8.6	11.5

Refer to § 10 , page 81 for the regulator input/output tests.

10. ELECTRICAL VALIDATION

Ecomod Heat Pump Control:

	Line No.	Value
• <u>Inputs/outputs test</u> menu		
Check the sensor values		
B10 line output sensor	Temp. sensor BX3 (7806)	--- °C
DHW sensor B3	Temp. sensor BX4 (7807)	--- °C
Check input H1/ H3		
Read return W3100 R1	Signal input H1 (7844)	--- (open)/°°°(closed)
Read return W3100 R2	Signal input H3 (7858)	--- (open)/°°°(closed)
Enable outputs		
Alarm output	Relay test (7700)	Output QX4
Hydraulic station control output	Relay test (7700)	Output QX3
Cancel enable	Relay test (7700)	No test
• <u>Generator diagnostics</u> menu		
Check the values for the heat pump in use		
Heat pump flow sensor	Heat pump flow temperature (8412)	--- °C
Heat pump return sensor	Heat pump return temperature (8410)	--- °C
Compressor output sensor	Hot gas temperature (8415)	--- °C
Compressor input sensor	Gas suction temperature (8434)	--- °C
• <u>Modbus slave diagnostics</u> menu		
Compressor modulation	UX signal input port 1 (7611)	0...100 (Hz)
Fan modulation	UX signal input port 2 (7621)	---
Circulation pump modulation	UX signal input port 3 (7631)	---
• <u>Consumer diagnostics</u> menu		
Check the value of the HP outdoor temperature sensor		
Outdoor temperature	Outdoor temperature (8700)	--- °C

11. LACK OF WATER SAFETY FUNCTION

WARNING:

The Ecomod Heat Pump Control system does not provide a lack of water safety function for the installation..

We recommend installing an outside safety system that switches off the Ecomod Heat Pump Control and forces the Ecomod to stop via dry contact input DI3 (refer to the Ecomod instructions) if the installation comes to lack water.

Installation recommendations:

- Install a pressure sensor on the power supply contact on the Ecomod Heat Pump Control
- Install a pressure sensor on the outside safety input to the Ecomod controller (refer to the Ecomod instructions)

12. SPARE PARTS LIST

ITEM	DESIGNATION	REF. FOR MODELS Ideal
001	Empty Ecomod Heat Pump Control case	AH79681
002	Ecomod Heat Pump Control lock with key	AH79689
003	Ecomod Heat Pump Control door only	AH79685
004	Ecomod Heat Pump Control OCI interface	AH79700
005	RVS21 board, Ecomod Heat Pump Control with board mounting + fuse + fuse cover	AH79696
006	Ecomod Heat Pump Control WAGO terminal blocks (x2)	AH79697
007	AVS37 display with Ecomod Heat Pump Control wiring	AH79695
008	Ecomod Heat Pump Control green power on switch	AH79692
009	Ecomod Heat Pump Control red fault indicator light	AH79691
010	Ecomod Heat Pump Control switch cover	AH79694
011	Ecomod Heat Pump Control wall mounting	AH79690
	Ecomod Heat Pump Control x84 x86 connectors	AH79698
	Complete wiring set with Ecomod Heat Pump Control connectors	AH79699

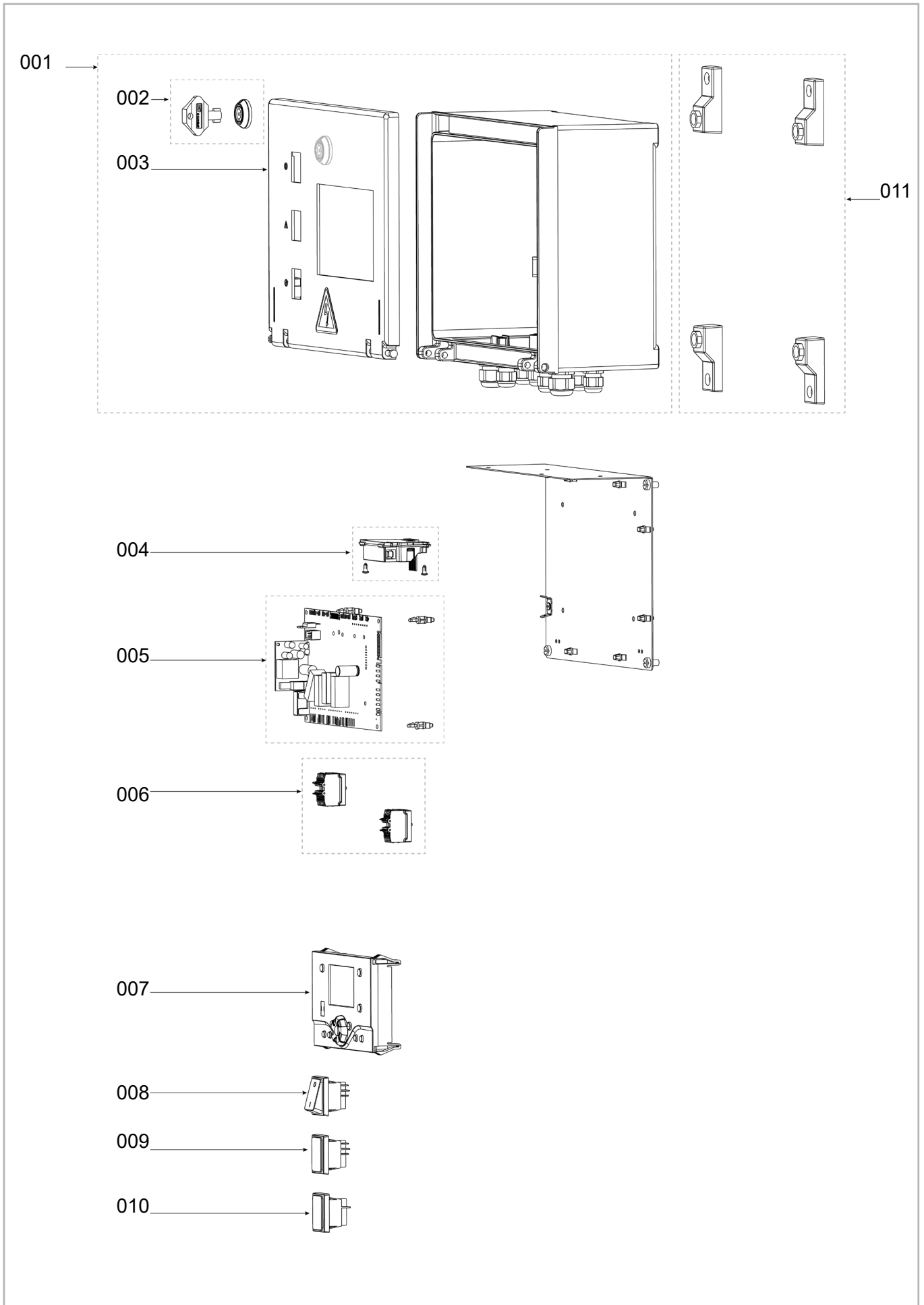

figure 22 - Ecomod Heat Pump Control set

13. ADDITIONAL ACCESSORIES

Each additional accessory is delivered with its own instructions (fitting, electrical connections and use).

13.1. Temperature sensors

13.1.1. Sensors not included with the control panel (to be ordered separately as accessories)

- 2 QAZ36 immersion sensors: (CTN 10 k Ω ; 25°C)
Ref. AH059261

Install the sensor in the sensor immersion sleeve. Bulb length 40.5 mm, diameter 6 mm.	
Connection: 2-wire cable, length 6 m.	
Protection: not shown.	Measuring range: 0..95°C

13.1.2. LPB OCI345 bridge (cascade accessory to be ordered separately)

- The OCI 345 is an LPB bus bridge to BSB bus (internal regulator)
Ref. AH059752
4.5mm² cable, 2 non-swappable wires, 250m

13.1.3. Sensor characteristics**13.1.3.1. CTN 1 k / QAZ34**

T[°C]	R[Ohm]	T[°C]	R[Ohm]	T[°C]	R[Ohm]	T[°C]	R[Ohm]	T[°C]	R[Ohm]
-30.0	13'034	-13.0	5'303	4.0	2'387	21.0	1'170	38.0	617
-29.0	12'324	-12.0	5'046	5.0	2'284	22.0	1'125	39.0	595
-28.0	11'657	-11.0	4'804	6.0	2'186	23.0	1'081	40.0	575
-27.0	11'031	-10.0	4'574	7.0	2'093	24.0	1'040	41.0	555
-26.0	10'442	-9.0	4'358	8.0	2'004	25.0	1'000	42.0	536
-25.0	9'889	-8.0	4'152	9.0	1'920	26.0	962	43.0	517
-24.0	9'369	-7.0	3'958	10.0	1'840	27.0	926	44.0	500
-23.0	8'880	-6.0	3'774	11.0	1'763	28.0	892	45.0	483
-22.0	8'420	-5.0	3'600	12.0	1'690	29.0	859	46.0	466
-21.0	7'986	-4.0	3'435	13.0	1'621	30.0	827	47.0	451
-20.0	7'578	-3.0	3'279	14.0	1'555	31.0	796	48.0	436
-19.0	7'193	-2.0	3'131	15.0	1'492	32.0	767	49.0	421
-18.0	6'831	-1.0	2'990	16.0	1'433	33.0	740	50.0	407
-17.0	6'489	0.0	2'857	17.0	1'375	34.0	713		
-16.0	6'166	1.0	2'730	18.0	1'320	35.0	687		
-15.0	5'861	2.0	2'610	19.0	1'268	36.0	663		
-14.0	5'574	3.0	2'496	20.0	1'218	37.0	640		

13.1.3.2. CTN 10 k / QAZ36

T[°C]	R[Ohm]	T[°C]	R[Ohm]	T[°C]	R[Ohm]	T[°C]	R[Ohm]	T[°C]	R[Ohm]
-30.0	175203	20.0	12488	70.0	1753	120.0	387	170.0	117
-25.0	129289	25.0	10000	75.0	1481	125.0	339	175.0	105
-20.0	96360	30.0	8059	80.0	1256	130.0	298	180.0	95
-15.0	72502	35.0	6535	85.0	1070	135.0	262	185.0	85
-10.0	55047	40.0	5330	90.0	915	140.0	232	190.0	77
-5.0	42158	45.0	4372	95.0	786	145.0	206	195.0	70
0.0	32555	50.0	3605	100.0	677	150.0	183	200.0	64
5.0	25339	55.0	2989	105.0	586	155.0	163		
10.0	19873	60.0	2490	110.0	508	160.0	145		
15.0	15699	65.0	2084	115.0	443	165.0	130		

Check list prior to commissioning Ecomod

Please refer to the Ecomod manual for more details on the criteria for accepting readings

Outdoor unit:

Outdoor positioning (check that the recommendations are complied with): Outdoors Alcove Other

Distances compliant with the environment: Yes No

Neighbourhood distancing: Yes No

Ventilation distance (VMC, chimney, HP): Yes No

Studs or anti-vibration system present: Yes No

HP raised above the ground: Yes No

Insulated and traced exterior pipes: Yes No

Condensate drain connected and protected against frost

Yes No.

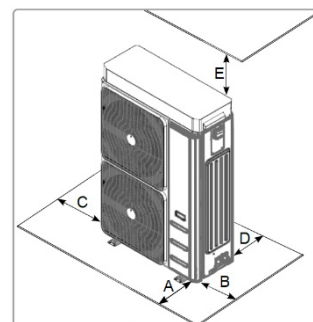

MODÈLE	A (mm)	B (mm)	C (mm)	D (mm)	E (mm)
AHP60 14 - 18 kW	1500	500	400	400	500
AHP60 26 - 32 kW	1500	700	400	400	-

AHP60 50 – 70 kW: see instructions

Each Ecomod communication bus connected to its controller regulation: Yes No

Primary hydraulic circuit

Hydraulics performed according to the diagram provided in the study: Yes No

Fluid conveyed: Water Water + Glycol Content in %:

Boiler room hydraulic pressure: Bar HP hydraulic pressure: Bar

Top-up water meter present: Yes No

Sieve filter present on the return HP: Yes No

Tank return balancing valve present: Yes No

In cascade, balancing valve present on each HP: Yes No

Softener present for the top-up water: Yes No

No automatic water top-up: Yes No

Expansion system connected and filled with water: Yes No

Air bleeder present on each high point: Yes No

Decoupling bottle present between the hydraulic station and the HPs: Yes No

Fitting and wiring of the decoupling bottle flow sensor (location according to instructions): Yes No

Hydraulic station and DHW tanks:

- Communication connected between the station and the controller No.1 (3 pairs): Yes No
- A group or a safety valve is directly connected to each tank: Yes No
- Valve calibration according to the operating pressure of the tank: Yes No
- Anode(s) fitted to each DHW tank: Yes No
- Safety mixer present upstream of the draw-off points: Yes No
- Several pre-heating tanks installed, hydraulic station return 2WV present: Yes No
- Fitting and wiring of the preheating tank sensor B3 (location according to instructions): Yes No

Check of the HP input power supply (do not switch on):

Caution: Switching on the product using a temporary power supply/construction kit is prohibited.

- Proximity switch disconnecter present: Yes No
- Three-phase + neutral power supply with subscription suitable for HP capacities: Yes No
- HP circuit breaker amperage and curve compliance: Yes No
- Compliance with HP power cable sections: Yes No
- Check that connections are tight: Done

Pre-operations: With the disconnect switch open, please open the fuse holders contained in the HP, then close the HP’s main circuit breaker, and then the proximity switch.

Readings to be taken at the Ecomod input without closing the fuse holders:

Mesures à effectuer	Valeurs relevées
Tension Neutre – Terre (NT) Volts
Tension Phase 1 – Neutre (PN) Volts
Tension Phase 1 – Terre (PT) Volts
Tension Phase 1 – Phase 2 Volts
Tension Phase 2 – Phase 3 Volts
Tension Phase 3 – Phase 1 Volts



The measured NT voltage should be approx. 0 Vac (~5 Vac allowed)

The PT and PN voltages should be approx. 230Vac +/-10% with a stable value.

The voltages between the phases must be identical and approx. 380Vac +/-10% with a stable value.

If the readings taken are consistent, please open the proximity switch and close the fuse holders.



CAUTION:

You can now turn on the HP, **you should not try to start it!**
 Please check that the display lights up. If this is not the case, a 2-phase inversion must be performed. See chapter § of the Ecomod manual.
 The heating cord will gradually heat the compressor.
 This operation must be performed for at least 12 hours before a start-up operation or after a long shutdown period.
 You can then fill the HP with water and carry out the air purge. See section §

Caution ! This reading does not constitute a boiler room report.

Technical Training

The Ideal Technical Training Centre offers a series of first class training courses for domestic, commercial and industrial heating installers, engineers and system specifiers.
For details of courses please ring:..... 01482 498432



Ideal Boilers Ltd. pursues a policy of continuing improvement in the design and performance of its products.
The right is therefore reserved to vary specification without notice.

Ideal is a trademark of Ideal Boilers.

Registered Office

Ideal Boilers Ltd., PO Box 103, National Avenue, Kingston Upon Hull, HU5 4JN

Tel 01482 492251 Fax 01482 448858

Registration No. London 322 137

Ideal Technical Helpline: 01482 498376
www.idealcommercialboilers.com