

ECOMOD BACKUP IMMERSION HEATER

Installed on:
ECOMOD HP BUFFER TANK BR

Document n° U0701399-C / 24.01.2023

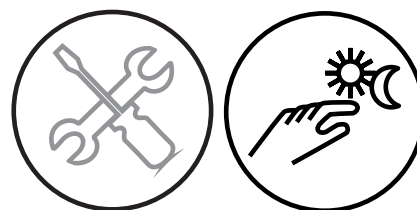

**Instructions
for installation,
use and
maintenance**



ideal
HEATING

SITE DE CAUROI

Route de Solesmes
FR - 59400 CAUROI



1. WARNINGS



DANGER:

When working on siliceous artificial mineral fibre components (ceramic fibres, glass wool, rock wool), the operator must wear suitable clothing and a respiratory protection mask to avoid any risk specific to these products.



DANGER:

The replacement of the shielded heating element must be carried out on equipment that is disconnected from the electrical grid.

2. GENERAL INFORMATION

The kit you have just received is intended for the installation (or replacement) of the shielded heating element in Ecomod HP buffer tanks.

These heating elements are available in 6kW, 15 kW and 30 kW straight versions.



IMPORTANT:

Drain the tanks, before installing the heating element.

3. RESISTOR REMOVAL PROCEDURE FOR MAINTENANCE OR REPLACEMENT



DANGER:

In the event of replacement, before opening the cover, disconnect the equipment from the electrical grid.

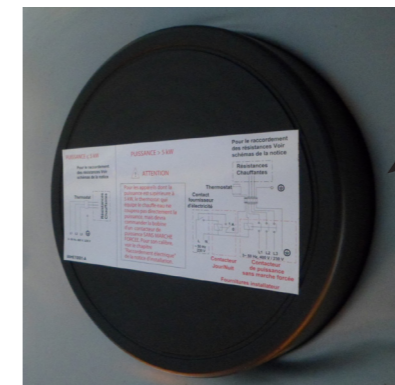

Remove the plastic cover (unscrew the retaining screw) to access the shielded heating elements.

4. DISMANTLING THE OLD HEATING ELEMENT

In the case of tanks with no shielded heating element, a plate is to be positioned in place of the heating element. The dismantling procedure is identical with or without a heating element:

- 1 – Disconnect the heating element from the power supply.
- 2 – a) Remove the cover's retaining screw
b) Pull the power supply wires from the cover (through the cable gland).
- 3 – Using a 13 wrench, remove the nuts:

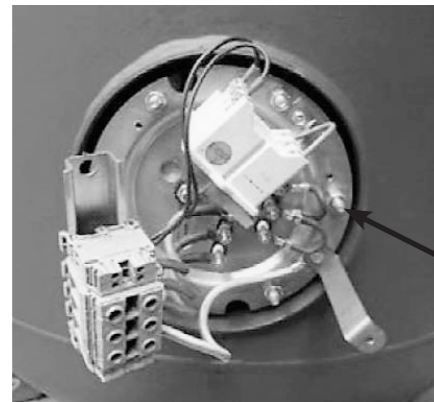

6 M8 nuts

- 4 – Remove the heating element and the seal.

5. INSTALLING A NEW OR REPLACEMENT RESISTOR

5.1. Positioning

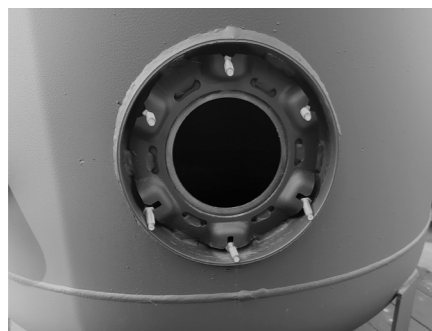

- 1 – Fit the seal supplied with this kit (wider part towards the exterior).

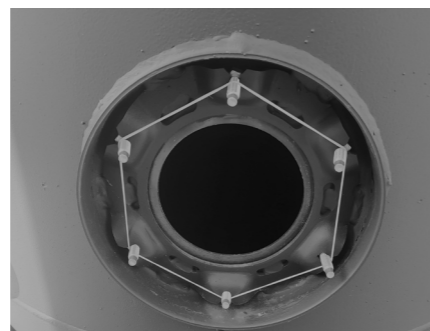

- 2 – Place the elastic band around the screws.

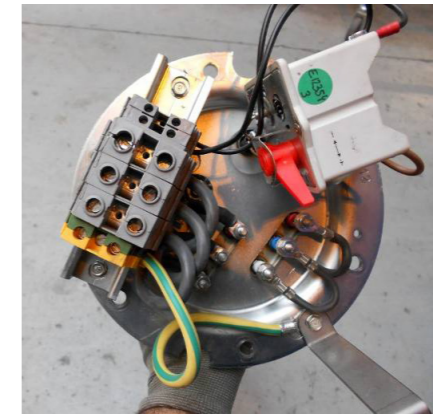

- 3 – On the heating element, remove the 2 M5 screws from the terminal block.



- 4 – Fit the heating element (thermostat at the top) and criss-cross tighten the assembly using the 6 M8 nuts. Tightening torque: 8 Nm

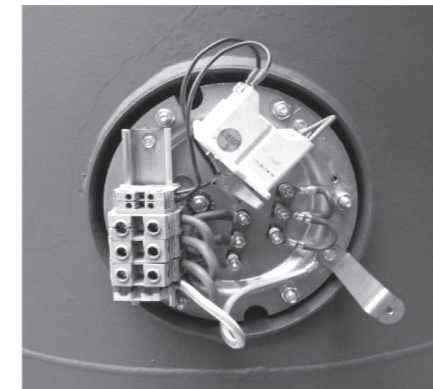

- 5 – Reassemble the terminal block using the 2 M5 screws.



- 6 – Connect the heating element and secure the cover using the M5 screw.



IMPORTANT:

Check the correct earth wire connection.

- 7 – Replace the old label with the one supplied in the kit

5.2. Electrical connection

The electrical installation must comply with the regulations in force.

Provide lockout via a circuit breaker or a fuse block upstream of the equipment.



CAUTION:

Imperative: the thermostat must control the coil of a power contactor relay WITHOUT ON FORCED OPERATION. This contactor must be installed by the installer: see paragraph 5.3 for its selection.

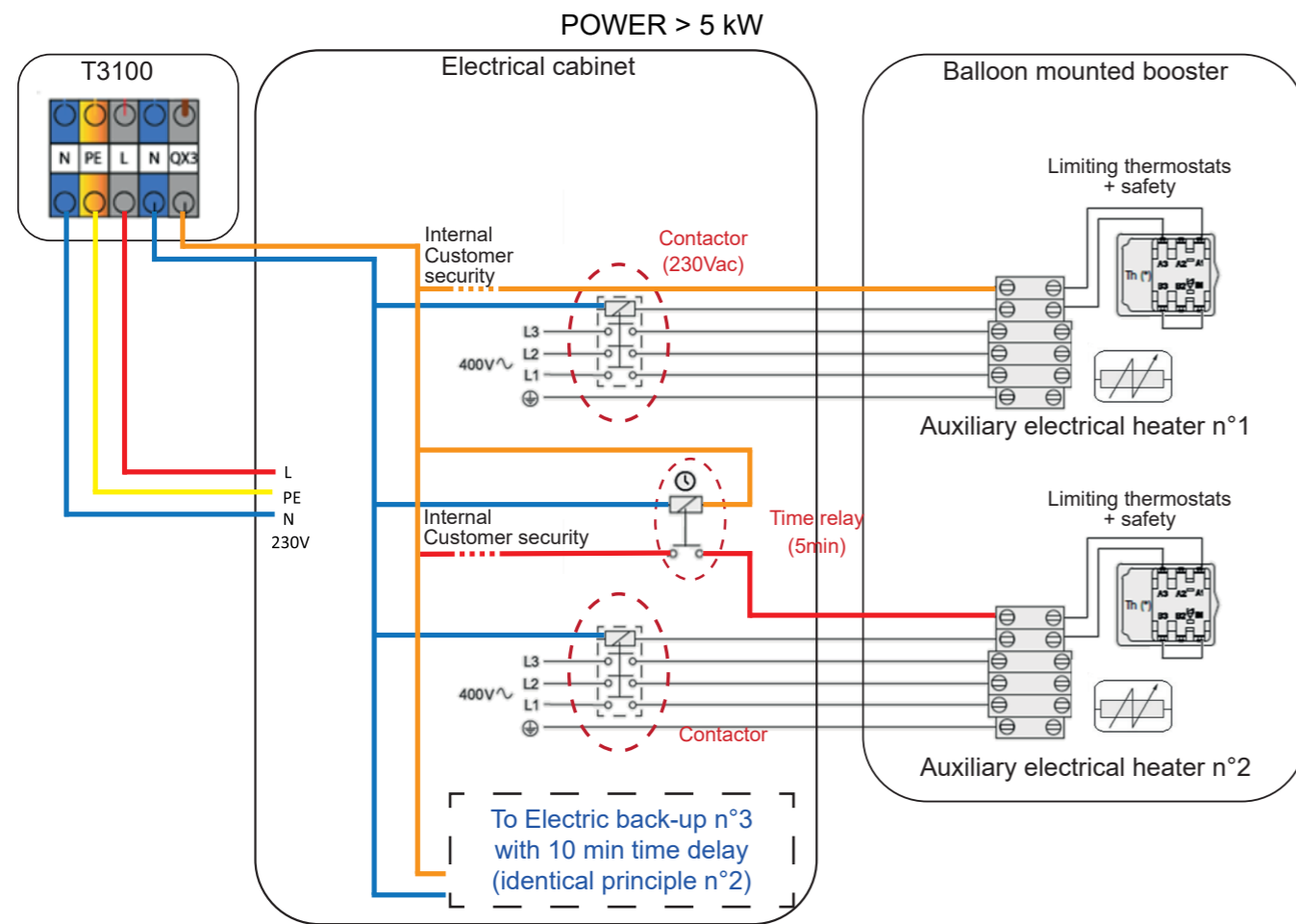

5.3. Conductor sections and power contactor gauges

P (kW)	3-phase 400V		
	I (A)	S (mm ²)	C (A)
6	8,7	2,5	10
15	21,7	2,5	25
30	43,3	10	50

P: Power I: Current C: Contactor

S: Min. conductor section: cross-section values are given as a guide only, comply with standard NF C1500 (cable length and laying method)

Coupling	6 kW and 15 kW	30kW
3-phase 400V		

Original wiring :

- Star wiring for 6 kW and 15 kW
- Triangle wiring for 30 kW

Resistance model (kW)	Minimum setpoint / landmark	Factory outlet setpoint (°C)	Maximum setpoint	Switch off thermostat safety (°C)
6 or 15 or 30	~ 20°C / SET 1	~ 65°C / SET 4	~ 80°C / SET 5	110 +/-7

At the installation, please set the aquastat to 4,5.



ATTENTION :

This setting applies to all the aquastats in the installation. A lower setting of the aquastat will interfere with the request for electrical back-ups by the Navistem T3100 and the B10 system flow sensor. Customer comfort can be impacted, as can the ability to provide the desired temperature.



CAUTION:

Never switch on the tank with no water inside it.



CAUTION:

In the case of the use of a composite material, PER etc, it is imperative to provide an external safety thermostat at the cut-off temperature adapted to the material.

6. (RE)FITTING THE COVER

- 1 – Put the cover in place by matching the holes in the cover with the flange.
- 2 – Fix the cover by means of the retaining screw.



IDEAL BOILERS LIMITED

National Avenue
EAST YORSHIRE
HU5 4JB HULL
GREAT BRITAIN
Tel. : 01202662511

Others countries, contact your local retailer

