

# INSTALLATION AND SERVICING

## ECOMOD 23 and 27 kW

Air/water monobloc heat pump

When replacing any part on this appliance, use only spare parts that you can be assured conform to the safety and performance specification that we require. Do not use reconditioned or copy parts that have not been clearly authorised by Ideal.

For the very latest copy of literature for specification and maintenance practices visit our website [www.idealcommercialboilers.com](http://www.idealcommercialboilers.com) where you can download the relevant information in PDF format.





# SOMMAIRE

<b>1. REGULATIONS, RECOMMENDATIONS AND WARNINGS .....</b>	<b>5</b>
1.1. Regulatory compliance.....	5
1.2. Recommendations and warnings.....	5
<b>2. DESCRIPTION OF THE EQUIPMENT .....</b>	<b>17</b>
2.1. Designations, definitions and scope.....	17
2.2. Packaging .....	17
2.3. Technical data .....	18
2.4. Description .....	21
2.5. Operating principle .....	28
<b>3. INSTALLATION .....</b>	<b>29</b>
3.1. Lifting and handling .....	29
3.2. Accessories supplied but not fitted.....	30
3.3. Installation .....	31
3.4. Installing the outdoor unit .....	31
3.5. Installing the control unit .....	37
3.6. Hydraulic connections .....	38
3.7. Raccordements électriques.....	46
<b>4. PRE-REQUISITES BEFORE COMMISSIONING .....</b>	<b>52</b>
4.1. Verification before switching on.....	52
4.2. Switching On .....	53
4.3. HP/Navistem pairing .....	53
4.4. HP hydraulic flow adjustment.....	54
4.5. Operating diagram .....	55
4.6. Navigating the User Interface.....	56
<b>5. CONTROL INTERFACE .....</b>	<b>57</b>
5.1. Recommendations and warnings.....	57
5.2. Interface utilisateur.....	59
5.3. HMI description .....	60
5.4. Thermostat display.....	65
5.5. Menu .....	67
<b>6. TROUBLESHOOTING .....</b>	<b>70</b>
6.1. Problem-solving without error code.....	70
6.2. Error codes and diagnostic assistance .....	71
<b>7. MAINTENANCE OF THE OUTDOOR UNIT.....</b>	<b>77</b>
7.1. Draining water from outdoor unit.....	77
7.2. Filling the outdoor unit with water.....	77
7.3. Prolonged shutdown .....	77
7.4. Periodic checks .....	78
7.5. Cleaning the external surfaces.....	80
7.6. Maintenance of the outdoor unit.....	80

7.7. Residual safety risks .....	81
7.8. "Maintenance" check list .....	86
<b>8. END OF PRODUCT LIFE .....</b>	<b>92</b>

Symbols used in this document



**INFORMATION:** This symbol draws attention to comments.



**CAUTION:** Failure to comply with these instructions may cause damage to the installation or to other objects.



**DANGER:** Failure to comply with these instructions may cause electrocution.



**DANGER:** Failure to comply with these instructions may cause injury and serious material damage.

**The purpose of this manual and how to use it**

The purpose of this manual is to provide the information required for the transport, handling, storage, installation and use of the monobloc R290 Heat Pump (HP) to which it refers. Anyone using the appliance should first familiarise themselves with the contents of this document.

Caution: any operation performed on the appliance may only be carried out by personnel duly trained and qualified for said operation.

After installation or maintenance operations, the qualified operator must inform the end operator/user of future maintenance to be carried out on the appliance.

This manual describes the appliance in its condition at the time of its sale. It therefore complies with latest developments in terms of safety and functionality.

The Ideal Heating is not obliged to perform an update of the appliance following developments that may arise after the sale of this appliance.

This manual must always be present and kept with the appliance to which it refers. It should be kept in a safe, clean, dry place that can be easily accessed by any operator required to work on the appliance.

# 1. REGULATIONS, RECOMMENDATIONS AND WARNINGS



## 1.1. Regulatory compliance

This outdoor unit has been designed in compliance with the regulations in force, and must be used within the framework of those regulations. In particular, it complies with the Machinery Directive, the Pressure Equipment Directive, and the Electromagnetic Compatibility Directive. It has also been designed in accordance with the Directives relating to eco-design and energy labelling.

This appliance must be transported in compliance with the ADR (Agreement on the Transport of Dangerous Goods on Roads).

This device and its refrigerant R290 must be handled in compliance with the application orders of the Decree 2007/737. Caution, this is a type A3 fluid, therefore suitable measures must be taken, some of which are mentioned later on in this chapter.

It must be installed in compliance with local or national regulations such as the RSD (Local sanitary Regulations), and in accordance with standard EN 378-3: 2016 concerning the installation of heat pumps.

The electrical connection must be made in compliance with the NF C 15-100 standard.

The hydraulic connection must be made in compliance with the DTU Plumbing 60.1 (NFP 40-201).

The instructions given below apply to any person working on the appliance.



### CAUTION:

**For its maintenance, this appliance requires the intervention of qualified personnel, possessing a certificate of capacity for the handling of refrigerants as well as training in the specificities and precautions to be taken related to products equipped with R290 refrigerant.**

## 1.2. Recommendations and warnings



### CAUTION:

**Before any operation, and upon delivery of the unit, check its condition. If the appliance or its packaging has been damaged, or if it is evident that the appliance has been tilted, check for an A3 fluid leak using a suitable device.**

### 1.2.1. Transport and storage

#### Storage

Store the appliance in a vertical position in a place where the temperature is between -10°C and +50 °C and the relative humidity is between 5 and 95%.

Do not stack.

Protect from humidity.

The propane in ECOMOD heat pumps is contained in a sealed circuit. These monobloc HPs are pre-charged at the factory and are subject to numerous normative requirements (traceability of components, numerous functional and leak tests, etc.). However, in exceptional cases, handling damage may occur and the refrigerant may then be released.

#### Risk prevention

We recommend the presence of a person trained in the risks related to propane. As this gas is odourless, it is necessary to keep a portable propane detector (with a sensitivity of 3g/year of refrigerant or better) on any site where our Ecomod HPs are stored. Indoor storage is allowed, however we recommend storage in warehouses where the following two conditions are met:

- the warehouse has at least two diametrically opposed openings (windows/doors, etc.) that can be used as natural ventilation in the event of an incident,



- it is possible to cut off all electrical sources in an area of 6 metres in the event of an incident (from the ground up to a height of 1.4m).

Otherwise, forced ventilation of the storage area is recommended. In all cases, there must be no potential sources of ignition within a 6-metre radius of the stored products (from the ground up to a height of 1.4m).

If there is a gutter or a wastewater manhole near a leak, there is a risk that the propane will accumulate and stagnate despite ventilation.

Do not remove the packaging and sheet metal panels from the unit.

### **Transport and handling**

In Europe, the transport of dangerous goods is regulated by the ADR (Agreement on the Transport of Dangerous Goods on Roads). These provisions also apply within borders. The Ecomod appliances are not subject to the ADR due to their R290 charge (less than 12kg per machine).

In order to minimise the risk of accident, it is necessary to respect the transport recommendations provided on the product leaflet.

We recommend the presence of a suitable ATEX zone 2 lamp (in case the load in the trailer needs to be checked).

The unit must not be in a horizontal position during transport or handling. Transport in a horizontal position may damage the appliance by moving the refrigerant and/or damaging the compressor's suspensions.

When handling and transporting this appliance, care must be taken to handle it carefully, avoiding any impact or friction with surrounding objects. Damage caused by transportation in a horizontal position is not covered by the warranty.



### **1.2.2. Unpacking the appliance**

With the carrier present, carefully check the general appearance of the packaging and the appliances. Check that the outdoor unit has not been placed in a horizontal position.

In the event of a dispute, write to the carrier within 48 hours mentioning all reserves and send a copy of this letter to the SATC department of the Ideal Heating.

Before unpacking the appliance, check that there are no refrigerant leaks using a suitable detector. Check that there are no ignition sources near the unit.

Smoking is forbidden near to the unit.

### **1.2.3. R290 refrigerant safety data sheet (Class A3)**

The handling and installation of this outdoor appliance must only be performed by personnel that are duly trained, qualified and authorised to carry out these operations, according to the laws, directives and standards applicable in each country.

The EN 378:2016 standard defines the framework of requirements to be met to manage each potential risk at each stage of the machine's life cycle. This standard was also used to design this machine.

The elements indicated below are not exhaustive given the diversity of the possible installations and interventions; they cannot be considered as an undertaking as to the responsibility of the Ideal Heating. These elements cannot replace a risk analysis, which remains the responsibility of the installer and the personnel working on the machines.



**CAUTION:**

**In the absence of local building codes or safety standards, the installation and maintenance of the machine may follow the elements outlined in this EN 378:2016 standard; in particular, it is the responsibility of the installer or the operator carrying out operations on this machine to perform a risk analysis prior to any installation and any work on the machine.**



Designation	R290
INDICATION OF DANGERS	
Main dangers:	<b>Highly flammable and explosive class A3 fluid.</b> R290 vapours are heavier than air and can cause asphyxiation due to an oxygen concentration level reduced to a level at which the fluid can stagnate.
Specific dangers:	Contact with R290 fluid in liquid form can cause frostbite.
FIRST AID MEASURES	
General information	In case of a high concentration, the fluid can cause asphyxiation. Loss of mobility and/or consciousness are characteristic symptoms. A narcotic effect may be observed at a lower concentration level.
Inhalation	Wear a self-contained breathing apparatus, and transport the victim to an uncontaminated location. Use oxygen or artificial respiration if required. Keep victim in a prone position and warm. Call a doctor.
Contact with the eyes	Rinse thoroughly with water for at least 15 minutes and seek medical attention.
Contact with the skin	Rinse thoroughly with water for at least 15 minutes. Apply a sterile gauze. Remove contaminated clothing immediately.
FIRE PREVENTION MEASURES	
Means of extinction	Water spray, dry powder.
Specific dangers	Rupture or explosion of the recipient
Specific methods	Cool down the recipients by spraying with water from a safe position. If possible, stop the product from leaking. If possible, use a water spray to hose down the smoke. Move the recipients well clear of the fire zone if possible without taking risks.
MEASURES IN THE EVENT OF AN ACCIDENTAL LEAK	
Individual precautions	Use specific personal protection equipment. Evacuate the personnel to safe areas. Eliminate any source of ignition such as cigarettes, electronic devices (computer, mobile phone, electronic cigarette), tools, including non-electric tools and clothing, that are not compatible with the risk of formation of an explosive atmosphere (ATEX) or are composed of less than 80% cotton. Ensure adequate ventilation, whether natural or from an ATEX ventilator. Do not enter manholes, basement window wells, excavations, or any other surrounding area where the risk of dangerous accumulation of fluid exists.
Environmental precautions	If the situation allows, try to stop the leak
Decontamination methods	Ventilate the area.
HANDLING AND STORAGE	
Handling: technical measures/precautions	Ensure that the premises have adequate air renewal/extraction. Do not smoke. Keep clear of any sources of ignition, including electrostatic discharge. Use only equipment that is suitable for the product and ATEX
Recommendations for safe use	Do not inhale the fluid in gaseous form



Storage	Close tightly and store in a cool, dry, well-ventilated place. Keep in original recipients. Storage containers should be checked periodically. Do not store with other oxidising elements or other combustible materials. All electrical/electronic equipment located in the storage area must be compatible with the risk of the formation of an explosive atmosphere (ATEX).
<b>CONTROLLED EXPOSURE/INDIVIDUAL PROTECTION</b>	
Control parameters	OEL: No data available DNEL: No data available PNEC: No data available
Respiratory protection	Filter masks may be used where ambient conditions or duration of use are known.
Protection of the eyes	Safety glasses
Hand protection	Rubber work gloves
Hygiene measures	Do not smoke
<b>PHYSICAL AND CHEMICAL PROPERTIES</b>	
Colour	Colourless.
Odour	Odourless
Boiling point	-42.1°C at atmospheric pressure
Flash point	470°C
Relative density in gaseous form (air = 1)	1.5
Relative density in liquid form (water=1)	0.58
Solubility in water	75 mg/l
<b>STABILITY AND REACTIVITY</b>	
Stability	Stable in normal conditions.
Materials to be avoided and Hazardous products resulting from decomposition	Air, oxidising agents. Keep away from any source of heat/sparks/open flames/hot surfaces. Under normal conditions of storage and use, no hazardous product resulting from decomposition should be generated.
<b>TOXICOLOGICAL INFORMATION</b>	
High toxicity	CL50 / inhalation / 4 hours / test on a rat = 20000 ppm.
Local effects	No known effects
Long term toxicity	No known effects
<b>ENVIRONMENTAL INFORMATION</b>	
Global warming potential (GWP – R744=1)	3
Ozone damage potential (ODP– R11=1)	0
Disposal	Comply with the supplier's gas collection programme. Avoid direct emission into the atmosphere. Do not drain in an area where the accumulation of fluid is dangerous. Ensure that emission limits required by local regulations are strictly adhered to.



## Warning specific to the R290 refrigerant



### CAUTION:

This appliance functions with class A3 R290 fluid (ASHRAE classification 34). In the event of a leak, the diffusion of R290 into the environment can lead to the formation of a highly flammable and explosive atmosphere.

R290 refrigerant gas has no odour.

**DANGER OF DEATH or serious injury:** the safety instructions listed below must be followed.

Do not smoke or use an open flame near the unit, and display this prohibition near the unit.

Do not inhale the gas.

Ensure that the installation area is well-ventilated.

Do not puncture or burn the refrigerant circuit.

Do not position the unit in proximity of ignition sources, open flames, electric heaters, etc.

Install the unit outdoors in compliance with the prescribed technical spaces and danger zones indicated in this manual.

Any special work or repairs to the appliance must be carried out by specialised and duly qualified personnel.

Persons using electrical/electronic medical devices or metal prostheses must take safety measures when working on the heat pump, and ensure that it is permissible to work as part of a refrigeration installation (electrical risk, risk of formation of an explosive atmosphere in particular).

After the installation of the machine and before any maintenance, ensure that no R290 gas concentration can be measured in the danger zone around the unit by means of a gas leak test.

## Draining and charging refrigerant



Refrigerant gas draining, charging and recovery procedures may only be performed by specialised technicians or qualified personnel who have received adequate training in the handling of flammable gas, have specific skills, and comply with local laws.

The refrigerant charging procedure is described in paragraph 3.6.7. of this document.

Below is a list of safety precautions that is not necessarily exhaustive:

Ensure that no other substance is contaminating the R290 fluid.

To recover refrigerant gas, use bottles with a left-hand fitting and a suitable screw thread.

The maximum filling capacity must be 0.42kg/l.

Before charging refrigerant gas, perform three flushing cycles with pressurised nitrogen, followed by an appropriate draining procedure.

Before charging, perform a leak check procedure. This operation has two purposes, to control the quantity of refrigerant charged and to check the circuit for leaks,

Keep the replacement bottle in a vertical position when charging.

Put a suitable label on the unit after charging.

Use work equipment that is suitable for flammable gases (see Chapter 1.2.7. for more information). Always ensure that the work area is well ventilated and use R290 detection devices.

Do not charge more refrigerant gas than needed.

After charging is complete, perform leak detection operations prior to operational testing.

After the functional test, we recommend carrying out another leak test,



### CAUTION:

Each unit is equipped with two charging connectors (high-pressure side and low-pressure side) for charging and discharging the refrigerant circuit. The maximum tightening torque of the charging connectors is 0.5 Nm.



### CAUTION:

The appliance is delivered already charged with the refrigerant gas necessary for its proper operation. If it is necessary to recharge it, after maintenance or after a leak, follow the procedures described in Chapter 3.6.7.



### CAUTION:

When performing the charging and recovery procedure on the unit, be aware of possible refrigerant gas leaks that could cause a fire. A risk assessment must always be carried out and the necessary preventive measures applied.

## R290 fluid removal

Follow the standardised procedures for collecting refrigerants, which may only be carried out by specialised technicians or qualified personnel, and return it to the supplier.

Do not discharge the gas into areas where there is a risk of the formation of an explosive mixture with air.

Use only equipment that has been approved for use with R290 and ATEX.

When removing and disposing of refrigerant, make sure that air does not enter the places where refrigerant is present.



### CAUTION:

During the refrigerant removal procedure, be aware of possible gas leaks that could cause a fire.

## Precautions related to the installation of the refrigerant



If local construction codes or safety standards do not exist, the information shown below, which is taken from standard EN 378:2016, may be used for information purposes only; it can be used as a guide for the safe use of machines that use a refrigerant.



**This appliance must not be installed in a place that the general public or untrained, unqualified or unauthorised persons can access.**



### IMPORTANT:

The refrigeration circuit of this unit is not hermetically sealed as per EN 378. It is necessary to take this specificity into account when installing in ERPs.



### IMPORTANT:

The installation of an ECOMOD heat pump is prohibited in high-rise buildings (IGH)\*. It is prohibited to introduce R290 fluid into them according to the decree of 10 May 2019 amending the decree of 30 December 2011 on safety regulations for the construction of high-rise buildings and their protection against the risks of fire and panic.

This unit is designed for installation outdoors.

\*IGH (*Immeubles de Grande Hauteur*) = a high-rise building, any construction whose bottom floor of the last level (PBDN) is located, in relation to the highest floor level that is usable for the equipment of the public emergency and fire fighting services:

- higher than 50 metres for residential buildings, as defined in Article R.111-1,
- higher than 28 metres for all other buildings.

This unit must be installed in such a way that no refrigerant leaks can be introduced into the building and/or endanger people and property. Therefore:

**It must not be possible for the refrigerant to spill into a ventilation duct, under a door, hatch or similar opening in case of a leak. For this reason, the installer must follow the recommendations given in paragraph 2.4.3.**

## 1.2.4. Recommendations for hydraulic and electrical circuits

### Hydraulic connections



### CAUTION:

Connecting the domestic hot water circuit directly to the heat pump is absolutely **FORBIDDEN**, only a primary circuit isolated from the domestic circuit by a heat exchange device can be connected.

The water that passes through the machine is not drinkable.



### CAUTION:

It is absolutely **FORBIDDEN** to braze/weld/grind, etc. within 2m of the appliance without taking all the necessary measures related to an intervention on an R290 appliance (detection, ventilation, explosimeter).

The connection must comply with good engineering practices according to the regulations in force.

Reminder: Make the assembly seals according to good engineering practices in force for plumbing work:

Use suitable seals (fibre seals, O rings).

Use Teflon or hemp tape.

Use sealant (synthetic as required).

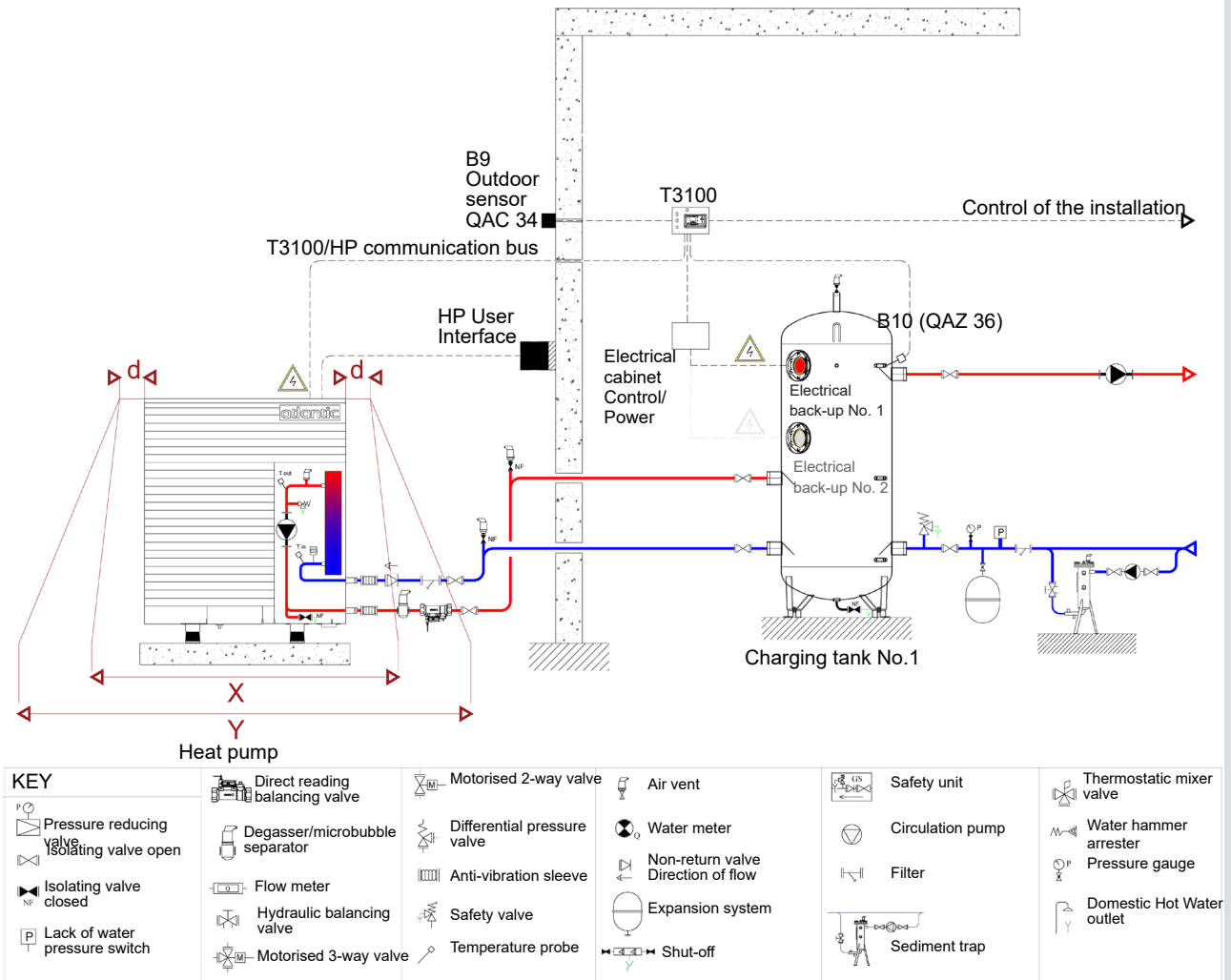

figure 1 - Example of recommended connection diagram (non exhaustive)

### Characteristics of the water for the appliance

To ensure that the appliance is working correctly, the water must be filtered correctly (see the indications at the beginning of this section) and the quantity of dissolved must be minimised. Refer to chapter 3.6.5. For further recommendations.

The properties of the water used for filling the primary circuit must comply with the following limits:

MAXIMUM AUTHORISED PHYSICAL-CHEMICAL CHARACTERISTICS AUTHORISED FOR THE INSTALLATION WATER	
PH	7,5 - 9
Electrical conductivity	100 - 500 $\mu$ S/cm
Total hardness	8,0 - 15,1 $^{\circ}$ f
Temperature	< 78 $^{\circ}$ C
Oxygen content	< 0,1 ppm
Phosphates (PO4)	< 2 ppm
Manganese (Mn)	< 0.05 ppm
Iron (Fe)	< 0,3 ppm
Alkalinity (HCO3)	70 – 300 ppm
Chlorine ions (Cl-)	< 50 ppm
Sulphate ions (SO4)	< 50 ppm
Sulphide ions	0 ppm
Ammonium ions (NH4)	0 ppm
Silica (SiO2)	< 30 ppm

**CAUTION:**

This unit is equipped with a high-efficiency refrigerant degassing device in case of the plate exchanger breaking.

**DANGER:**

**DANGER:** The introduction of R290 fluid into the building may generate a highly flammable or explosive atmosphere and is **STRICTLY PROHIBITED**.

For this reason, the degasser and the specific non-return valve are mandatory, see 3.6.6.2.

**Electrical connections****CAUTION:**

Ensure that the general electrical power supply has been cut off before starting any repair work.

The electrical installation must be conducted in accordance with the prevailing regulations in the country of installation. In particular, in France: standard NF C 15-100.

Never use a socket for the power supply.

The electrical installation must be equipped with a differential protection. This appliance is designed to operate under a nominal voltage of 400 V +/- 10%, 50 Hz.

The electrical connections will only be made when all of the other assembly operations (attachment, assembly,...) have been carried out.

**INFORMATION:**

The contract with the energy supplier must cover the maximum electrical requirement of the installation.

The outdoor unit must be supplied directly by a dedicated line, protected on the outgoing side by a type B differential protection, and with a proximity switch allowing the contacts to be separated in all poles (see paragraph 3.7.3. "Current source").

### 1.2.5. General safety rules



Before starting any work on the units, each operator must be thoroughly familiar with how the machine operates and its controls and must have read and understood all the information contained in this manual.



- The removal and/or handling of any safety device is strictly prohibited.
- Unaccompanied children and persons with disabilities are not allowed to use the appliance.
- Touching the appliance with bare feet or with wet or damp body parts is prohibited.
- Cleaning is prohibited when the appliance is powered on.
- Pulling, disconnecting or twisting the electrical cables coming out of the appliance, even if the appliance is disconnected from the power supply, is prohibited.
- Do not stand on the appliance, sit on it and/or place objects of any kind on it.
- Do not splash the appliance or spray water onto it.
- Do not disperse, put down or leave within the reach of children the packing material (cardboard, staples, plastic bags, etc.) as it can be a potential source of danger.



- All routine or extraordinary maintenance must be performed with the unit at a standstill without power supply.
- Do not put your hands or insert screwdrivers, wrenches or other tools into the moving parts.
- The person responsible for the machine and the maintenance technician must receive the appropriate training and instruction to perform their tasks in safety.
- Operators must be familiar with the personal protective equipment and the accident prevention rules prescribed by national and international laws and standards.
- For installations in environments where outdoor temperatures may be below 0°C, some components may freeze if the appliance is not in operation. Ensure that in the event of a risk of freezing, the heating system is running continuously and all parts are sufficiently heated. If operation cannot be guaranteed, have the heating system drained by a qualified technician.

### 1.2.6. Worker safety

The company declines all contractual and extra-contractual liability for damage to persons, animals or property caused by errors in installation, adjustment and maintenance, misuse or partial or superficial reading of the information contained in this manual.

These appliances are designed for heating and for outdoor use only in residential and commercial applications. Any other application, not expressly authorised by the manufacturer, must be considered inappropriate and is therefore not permitted. The fluid to be used is exclusively water.

Direct interaction with the appliance by people using electrically operated medical devices (such as pacemakers) is prohibited, as it may cause harmful interference. It is recommended to remain at a suitable distance from the unit's installation, as indicated by the medical system used.



**Wearers of electrically operated medical devices should exercise caution when interacting with the appliance.**



**Wearers of metal prostheses should exercise caution when interacting with the appliance.**



The European Community has published a number of directives concerning the safety and health of workers, including: 89/391/EEC, 89/686/EEC, 2009/104/EC, 86/188/EEC and 77/576/EEC, and successive integrations/amendments which each employer is obliged to respect and enforce. We would therefore like to remind you that:



It is forbidden to replace or modify parts that are not original manufacturer's parts. In this case, the Ideal Heating disclaims any civil or criminal liability.



Any person involved in handling in the danger zone must have received specific training on the risks associated with the use of R290 in thermodynamic equipment.



The appliance contains R290 flammable refrigerant gas. Any leakage of refrigerant can create a flammable atmosphere. Always carefully assess the risk of fire and explosion.



The use of components, consumables or spare parts other than those recommended by the manufacturer and/or mentioned in this manual may constitute a danger to the operators and/or damage the machine.



The operator's workstation must be kept clean, in order, and free of any objects that may restrict freedom of movement. The workstation must be sufficiently well-lit for the planned operations to be performed. Insufficient or excessive lighting can pose a risk.



Ensure that adequate ventilation of the working premises is always guaranteed and that the suction installations are functioning, in perfect condition and compliant with the legal provisions in force.



During the design phase, the indications contained in UNI EN ISO 14738 were followed with regard to workstations on machines and the lifting limits imposed by UNI ISO 11228-1 were evaluated.

R290 refrigerant in gaseous form is heavier than air, if dispersed into the environment it tends to concentrate strongly in poorly ventilated areas. Inhalation may cause dizziness and a feeling of suffocation and, if it comes into contact with naked flames or hot objects, lethal gases may be emitted (see the refrigerant data sheet).

It is important to be aware that refrigerants may not develop any odour.

When working on the heat pump system:



Wear appropriate PPE (especially gloves and safety glasses).

Ensure that the workplace is well ventilated. Do not work in closed rooms or pits with poor air recirculation.

Do not handle refrigerant near hot components or naked flames.

Verify that there is no current and that the appliance cannot be reconnected to the power supply during the work.

Avoid any dispersion of the refrigerant into the environment and pay special attention to accidental leaks from the pipes and/or fittings, even after draining the system.

Make sure that there is an extinguisher near the unit.

### 1.2.7. Personal protective equipment



When using and maintaining the units, personal protective equipment must be used, such as:



Leak detector: Before any operation, check that there are no gas leaks on the unit.



Clothing: Persons performing maintenance or working on the system should wear clothing that does not leave any parts of the body uncovered, as during maintenance there is the possibility of coming into contact with hot or sharp surfaces. Clothing that can get caught or be sucked in by the air flow should be avoided.

Avoid clothing that can catch on protruding surfaces or be sucked into an airflow.

Safety shoes with non-slip soles, especially in environments with a slippery floor.



Use footwear that is certified as antistatic (ESD).



Gloves: Protective gloves must be worn during cleaning and maintenance.



Mask and glasses: Safety glasses and a respiratory protection mask should be used during cleaning operations.



Explosimeter for R290 gas: During maintenance operations, each operator must be equipped with an explosimeter for R290 refrigerant gas to check for its presence in the air. The explosimeter must not be a possible source of ignition and its sensitivity must trigger an alarm for a concentration 20% lower than the lower flammability limit (LEL or LFL).



Tools: Recommended for use in the maintenance of products equipped with refrigerants, such as ATEX tools.



Explosimeter for R290 gas: During maintenance operations, each operator must be equipped with an explosimeter for R290 refrigerant gas to check for its presence in the air. The explosimeter must not be a possible source of ignition and its sensitivity must trigger an alarm for a concentration 20% lower than the lower flammability limit (LEL or LFL).



Tools: Recommended for use in the maintenance of products equipped with refrigerants, such as ATEX tools.

Personal protective equipment must be checked periodically and compatible with R290 refrigerant gas.



## 2. DESCRIPTION OF THE EQUIPMENT

### 2.1. Designations, definitions and scope

**Ecomod AHP70:**

Monobloc inverter heat pump operating with R290 refrigerant. This unit is suitable for producing hot water to irrigate heating networks, or domestic hot water separated by a heat exchanger.

The heat pump is sometimes also referred to as an outdoor unit.

**Air/Water:**

The outdoor air is the energy source. This energy is transmitted to the primary water circuit by the heat pump.

**Inverter:**

The fan and compressor speeds are modulated to suit the heat requirements which allows the noise level to be reduced. This technology makes it possible to save energy by avoiding high starting currents and by adjusting the power to the load.

**COP (Coefficient Of Performance):**

In instant production, this is the ratio between the power transmitted to the heating circuit and the electrical power consumed.

**Primary water or primary circuit:**

This is the water circuit directly connected to the heat pump, comprising the internal circuit of the unit, a cylinder or a tank, and connecting pipes between the two. The primary circuit must comply with a minimum volume as indicated in table § 2.3.1. to ensure the correct operation of the unit and its protection against short cycles and frost.

**DHW:**

Domestic Hot Water. Under no circumstances must DHW circulate in the hydraulic circuit of the heat pump. A heat exchange device **MUST** separate the primary water from the DHW.

### 2.2. Packaging

This package contains:

A monobloc outdoor unit or heat pump:

Modèle	Code produit
ECOMOD 23	239358
ECOMOD 23 AC*	239359
ECOMOD 27	239360
ECOMOD 27 AC*	239361

\*AC = Anti-corrosion treatment of finned batteries

A user interface to be connected to the outdoor unit as described in Chapter 3.7.4.

Other accessories according to connection - see Ecomod manual, heating application or DHW application.

## 2.3. Technical data

### 2.3.1. Technical Specifications

This product is designed to be installed at a maximum altitude of 2000m

TECHNICAL CHARACTERISTICS		Unit	i-290	i-290
			23Kw	27Kw
Heating	Minimum/nominal thermal power (1)	kW	22,8	27,0
	Absorbed power (1)	kW	4,8	6,2
	COP (1)	W/W	4,77	4,35
	Minimum/nominal thermal power (2)	kW	21,6	26,3
	Absorbed power (2)	kW	6,8	8,7
	COP (2)	W/W	3,18	3,01
	Minimum/nominal thermal power (7)	kW	21,2	25,8
	Absorbed power (7)	kW	8,0	10,3
	COP (7)	W/W	2,66	2,50
	SCOP (3)	W/W	4,72	4,46
	Water flow rate (1)	m <sup>3</sup> /h	0,65	0,79
	Useful head (1)	kPa	146	142
	Energy efficiency Water 35°C / 55°C	Class	A+++ / A++	A+++ / A++
Compressor	Type		Scroll DC Inverter	Scroll DC Inverter
	Oil (type)		PZ46M	PZ46M
	Number of compressors		1	1
	Quantity of oil	L	900	900
Refrigerant	Type		R290	R290
	Refrigerant load (8)	kg	1,7	2,1
	Quantity of refrigerant in CO2 equivalent (8)	t	0,005	0,006
	Operating pressure (upper/lower) in heat pump mode	bar	30,3 / 0,7	30,3 / 0,7
	Operating pressure (upper/lower) in cooling mode	bar	30,3 / 0,7	30,3 / 0,7
Internal exchanger	Water capacity	L	1,71	2,07
Fans	Type		EC	EC
	Nominal air flow rate (1)	m <sup>3</sup> /h	12810	13780
Hydraulic circuit	Hydraulic circuit water capacity	L	4	4
	Max. pressure on water side	bar	6	6
	Hydraulic connections	Ø	1" 1/4 M	1" 1/4 M
	Minimum volume of water for bottle	L	175	225
	Maximum power of circulator	kW	0,35	0,35
	Max absorbed current of the circulator	A	2,50	2,50
	Max temperature at HP exchanger output	°C	78°C	
	Recommended MAX setpoint temperature	°C	73°C	
Electrical data	Power supply		400V/3P+N+T/50Hz	
	Maximum absorbed power	kW	11	13
		kVA	13.2	15.2
Maximum absorbed current	A	19	22	

Acoustic emissions	Noise level Lw (9)	dB (A)	64	65
	Acoustic pressure at a distance of 10 m Lp1 (10)	dB (A)	33	34
Dimensions and weight	Length	mm	1610	
	Width	mm	710	
	Height	mm	1270	
	Length packed	mm	1780	
	Width packed	mm	820	
	Height packed	mm	1430	
	Weight for shipping	kg	276	285
	Weight in service	kg	254	264

The above performances are given for the following operating conditions, as per the standard UNI EN 14511:2022:  
(1) Heating: external air temperature 7°C dry temperature (dT) 6°C humid temperature (hT); inlet/outlet water temperature 30/35°C.

(2) Heating: external air temperature 7°C dry temperature (dT) 6°C wet bulb temperature (hT); inlet/outlet water temperature 47/55°C.

(3) Heating: average climatic conditions: T<sub>biv</sub> = -7°C; inlet/outlet water temperature 30/35°C.

(4) Cooling: external air temperature 35°C; inlet/outlet water temperature 12/7°C.

(5) Cooling: external air temperature 35°C; inlet/outlet water temperature 23/18°C.

(6) cooling: low temperature, variable output, fixed range.

(7) Heating: external air temperature 7°C dry temperature (dT) 6°C wet bulb temperature (hT); input/output water temperature 55/65°C.

(8) Indicative data and subject to variation. For the correct data, always refer to the data label on the unit.

(9) Noise level: heating mode under partial load as per Appendix A of EN 12102:2017; value determined based on measurements made as per UNI EN ISO 9614-1, in accordance with the requirements of HP Keymark certification.

(10) Acoustic pressure: value calculated from the original acoustic pressure level (9) as per ISO 3744:2010.

### 2.3.2. Ancillary electrical data

V/~ / Hz unit power supply	3P+N / ~400V / 50HZ
V/~ / Hz user interface circuit	2 / ~12V / 50Hz
V/~ / Hz fan power supply	2 / ~230V / 50Hz

\* Acceptable variations: +/- 10%

**REMARK: The electrical data may be modified. You must consequently refer to the data label on the RH side panel of the appliance.**

### 2.3.3. Noise emissions according to EN 12102-1:2022

The acoustic pressure data are values that are calculated from the acoustic power level in compliance with ISO 3744:2010, taking into account the units operating in the field.

#### 2.3.3.1. Under full load

Noise levels refer to units at full load under standard nominal conditions (1) and under normal test conditions in cooling mode. The tolerance on the value of the total acoustic power level is 2 dB (A). The value is determined in compliance with EN 12102-1: 2022, used together with EN ISO 9614-1:2009, which describes the test methods used with the intensimetric method.

Model	Acoustic power level per octave band dB(A)							Acoustic power level [Lw(A)] dB(A)	Acoustic pressure level at 10m dB(A)
	63 Hz	125 Hz	250 Hz	500 Hz	1000 Hz	2000 Hz	4000 Hz		
23kW	59.0	59.2	63.2	66.5	68.1	66.2	60.2	73	42
27kW	58.7	62.1	64.5	70.5	70.8	69.8	62.7	75	45

#### 2.3.3.2. Under partial load

Noise levels refer to units at partial load and under conditions guaranteeing a heat capacity equal to that declared at a temperature of 7°C for an average climate, as per EN 14825:2022, [dry temperature (humid temperature) of the external air = 7°C (6°C), input-output water temperature = 47-55°C]. The tolerance on the value of the total acoustic power level is 2 dB (A). The value is determined in accordance with standard EN 12102-1:2022, used together with EN ISO 9614-1:2009, which describes the test and measurement methods used with the intensimetric method.

Model	Acoustic power level per octave band dB(A)							Acoustic power level [Lw(A)] dB(A)	Acoustic pressure level at 10m dB(A)
	63 Hz	125 Hz	250 Hz	500 Hz	1000 Hz	2000 Hz	4000 Hz		
23Kw	42.8	51.0	52.8	61.5	57.4	55.1	48.0	64	33
27Kw	51.2	51.5	56.9	63.2	55.3	53.6	44.8	65	34

## 2.4. Description

### 2.4.1. Dimensions

IN/OUT : 1"1/4G

E : electricity supply input

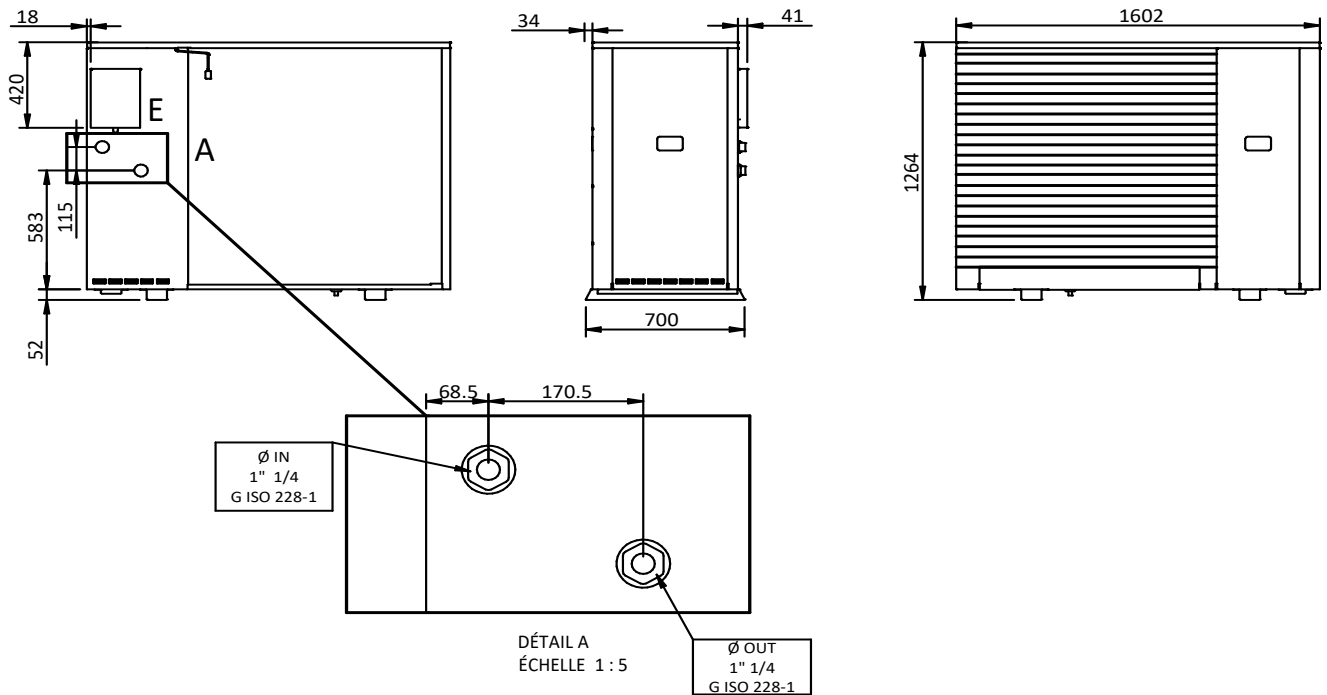
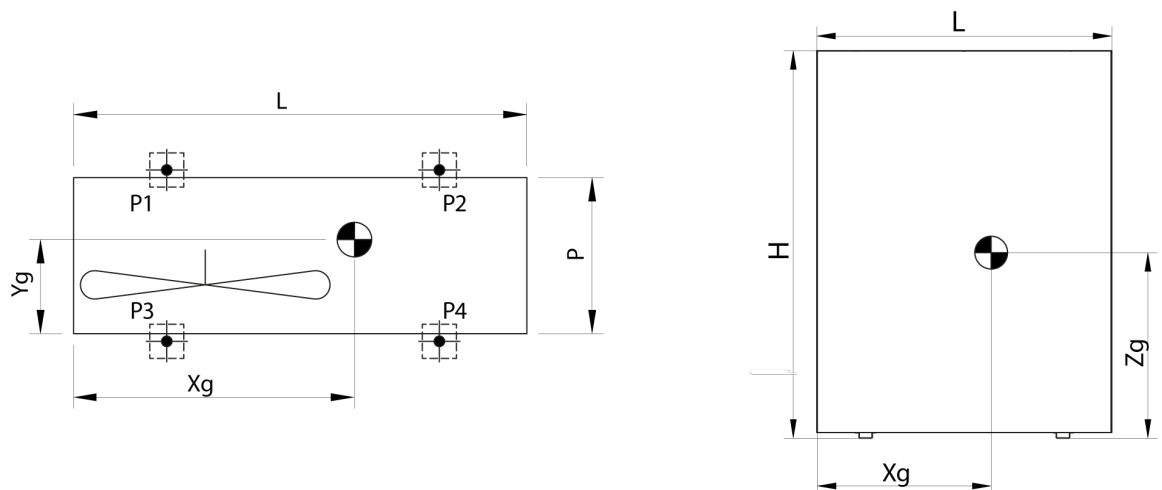

figure 2 - Dimensions of the appliance only, in mm

### 2.4.2. Position of the barycentre and the anti-vibration elements

The position of the centre of gravity of each machine is indicated in the tables, with reference to the dimensions indicated on the image.



Model	Shipping weight (kg)	Operating weight (kg)	L (mm)	W (mm)	H (mm)	Xg (mm)	Yg (mm)	Zg (mm)
23Kw	276	254	1610	710	1270	810	395	655
27Kw	285	264	1610	710	1270	800	410	655

The positions laid down for the installation of the vibration shock absorbers for each type of machine are presented in the images below.

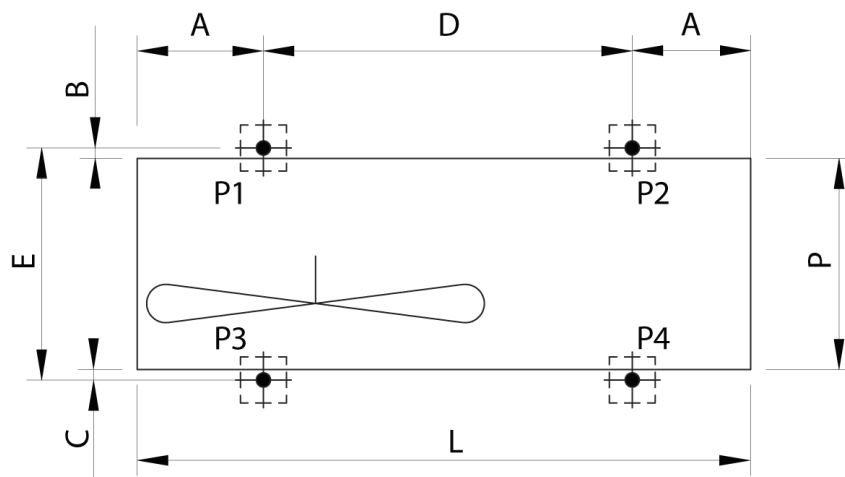

Modèle	A (mm)	B (mm)	C (mm)	D (mm)	E (mm)
23Kw	331	308.5	30	962.5	640
27Kw	331	30.85	30	962.5	640

### 2.4.3. Safety zone dimensions

The appliances contain R290 refrigerant gas. Since the density of this gas is higher than that of air, it tends, in the event of a leak, to disperse and stratify, accumulating in recesses or on the ground.



**INFORMATION:**

**This appliance must not be installed in a place that the general public or untrained, unqualified or unauthorised persons can access.**

When installing the appliances, it is mandatory to observe the danger and safety zones indicated in this manual. These zones have been established in accordance with EN 60079-10-1, with the estimation of an appropriate refrigerant loss, to ensure the safety of the units in the installation area.

A danger zone (X) is defined as an area around the machine in which, in the event of a refrigerant gas leak, a flammable atmosphere is formed for a short time, and in which it is necessary to implement all the precautions described in the manual. In the absence of specific standards or regulations, when using the unit in an industrial or working environment, it is advisable to classify the places that have a risk of explosion, taking into account the ATEX Directive 1999/92 (Directive 89/391).

There must be NO ignition sources in the danger zones, including:

- flammable gases and aerosols, powders that ignite themselves;
- electrical equipment that is not suitable for use in potentially explosive areas (zone 2 according to directive 89/391);
- open flames, heated surfaces (maximum surface temperature of 360°C) and heat treatment; smoking is prohibited, even with electronic cigarettes;
- sparks, electrostatic charges, the direct and indirect effects of lightning, eddy currents

and cathodic protection;

- ignition sources due to remote processes (ionising and non-ionising radiation);
- permanent electrical sources (switches, lights, etc.) or other possible triggers;

In addition, the danger zone must NOT:

- include potentially hazardous areas or features such as wells, manholes, openings to the sewer system and other openings to underground places and premises (e.g. oil wells, manholes, garages), waterway drains, power lines, flammable deposits, electrical installations, etc.;
- include doors, windows or glass panes, to prevent the possible return of gas to the interior of the building;
- extend towards nearby residential properties, parking areas, public access sites, roads or railways.

A safety zone (Y) extending beyond the danger zone must also be identified. In the safety zone, in the event of a refrigerant leak, the concentration of the gas in the air is generally below the critical levels for the formation of flammable or hazardous atmospheres.

Compliance with the following provisions remains mandatory:

- avoid accumulation and stagnation in underground spaces, drains, manholes, cellars, etc.;
- do not place building air vents inside or near the safety zone;
- do not use open flames or other direct heat sources.

In all cases, national and local regulations relating to the installation of machinery (where applicable) must be observed to avoid the formation of fire hazards and to prevent gases from entering the atmosphere, floor openings or lower floors.

The danger and safety zones may not be the subject of any structural modification that might alter their extent or modify the behaviour of the air-refrigerant mixture.

It is also strictly forbidden to alter, modify, remove or compromise, even partially, the functionality of devices, protective equipment and the requirements intended for the safety of property and persons.

In this manual, different types of outdoor installations are envisaged, as indicated in the following paragraphs.

### Open field installation

For units installed in open field, the danger zones (solid red line) and the safety zones (dotted black line) are shown in the figures below:

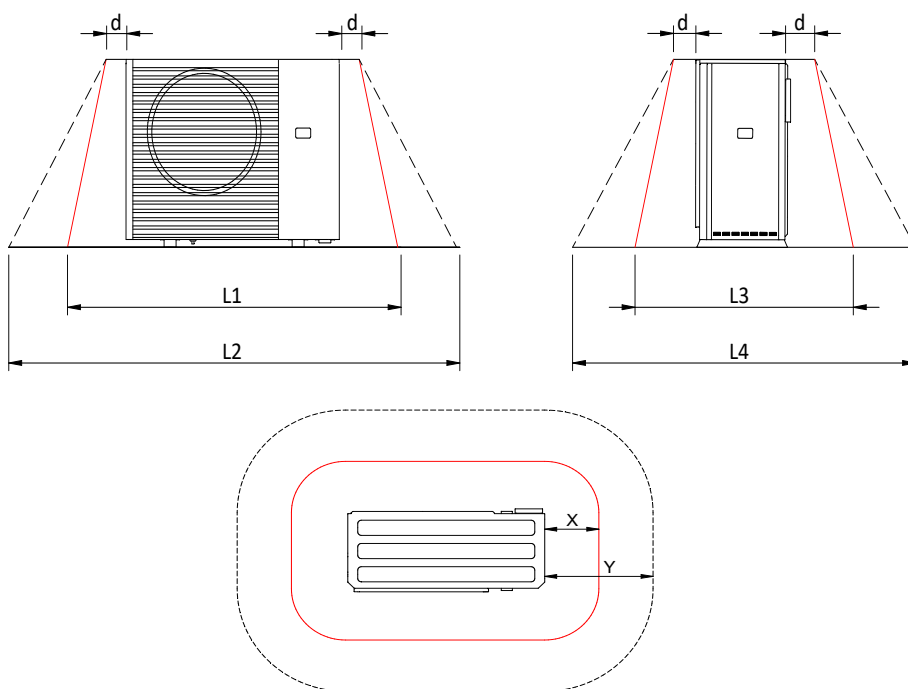

Limit	Dimension (mm)
X	1500
Y	2000
L1	4600
L2	5600
L3	3640
L4	4640
d	250

### Installation near an opening (door, window, low point, etc.)

In the case of units installed on the ground in front of a wall, the danger zones (solid red line) and the safety zones (dotted black line) are shown in the figures below:

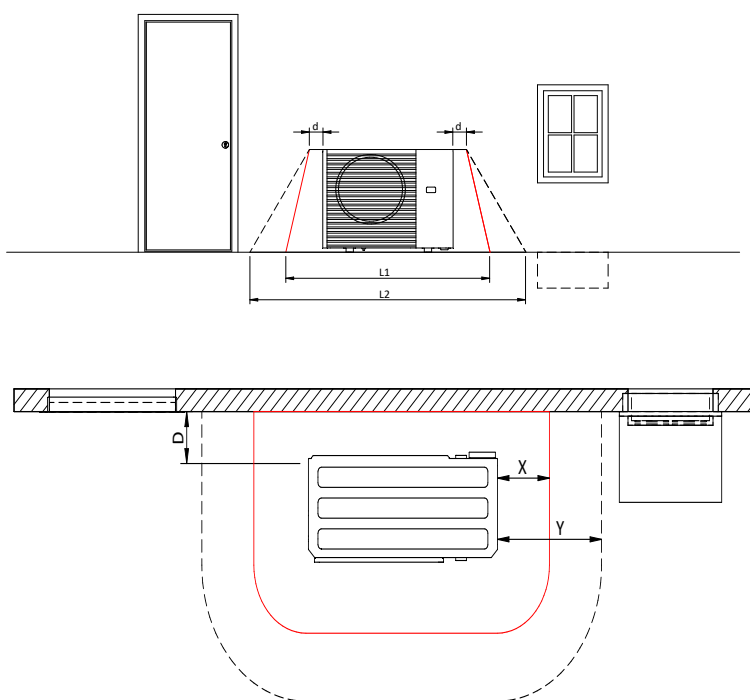

Limit	Dimension (mm)
X	1500
Y	2000
L1	4600
L2	5600
D	400
d	250



### Installation in a corner

For units installed on the ground in a corner, the danger zones (solid red line) and the safety zones (dotted black line) are shown in the figures below:

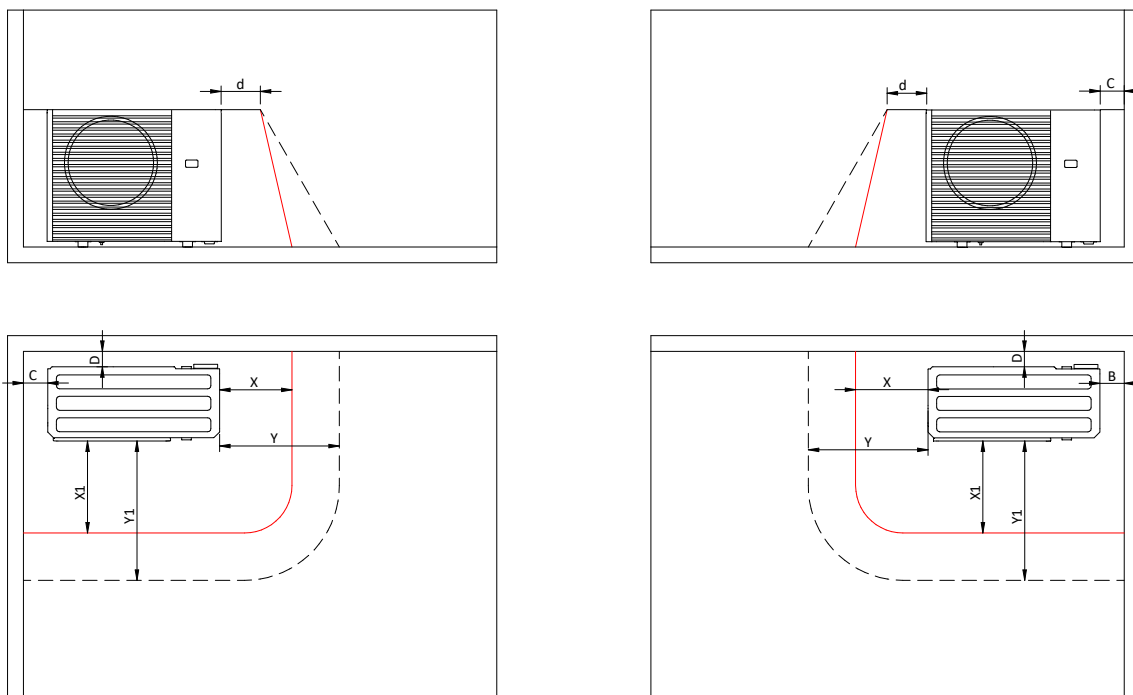

Limit	Dimension (mm)
X	1500
Y	2000
X1	2750
Y1	3250

Limit	Dimension (mm)
B	700
C	400
D	400
d	250

### Installation on a flat roof

The installation on a flat roof is similar to that on open ground, however some additional aspects must be taken into account:

Position the machine away from the exterior walls of the building and any protrusions, beyond the safety zone.

Ensure that the roof and building structures are strong; choose a location where snow, dust or leaves do not accumulate.

Bear noise emissions in mind and keep a sufficient distance from surrounding buildings. If high air speeds are encountered, install shields to reduce the wind speed (see Chapter 3. Installation).

Drains in the HP safety zone are prohibited.

## 2.4.4. Access to internal components



**CAUTION:**

All operations requiring access to the internal parts and the electrical panel must only be carried out with the machine switched off and disconnected from the power supply.

These operations must be carried out by qualified personnel.

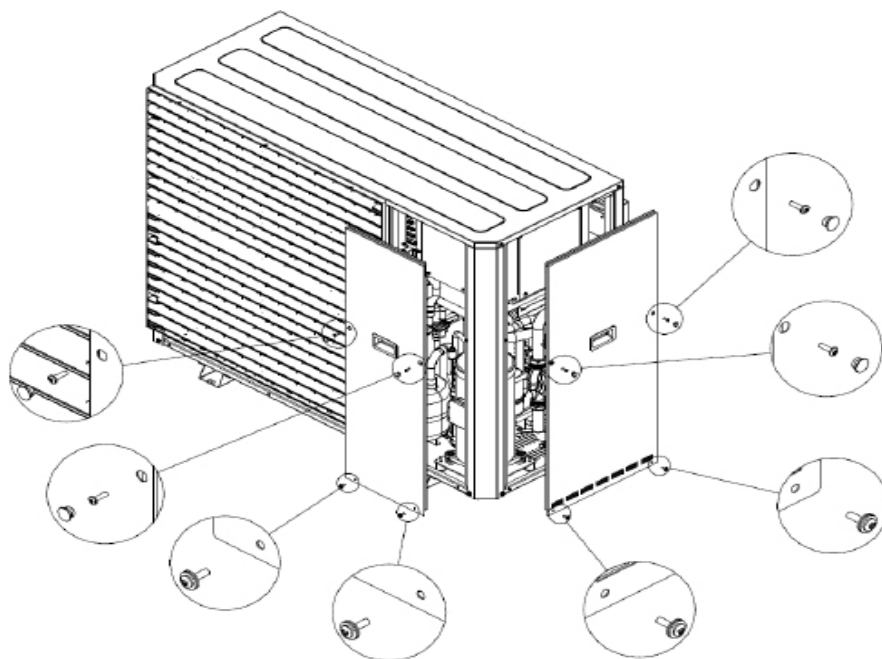

Remove the two component compartment access panels by loosening the screws as indicated in the figure.



**CAUTION:**

When the work is complete, refit all of the covers removed with the screws and seals provided (where applicable).

### 2.4.5. Position of the thermostat and the temperature sensors

The safety thermostat is located on the compressor head (position D in the figure). To access it, remove the insulation from the component.

Inside the machine, there are 5 temperature sensors: the return and discharge sensors on the water side (positions B, C) and the suction and discharge sensors on the compressor side (positions A, E) are located in dedicated wells, while the external air sensor (position F) is located on a dedicated support. The sensors on the compressor pipes are secured with clips to the respective thermowells.

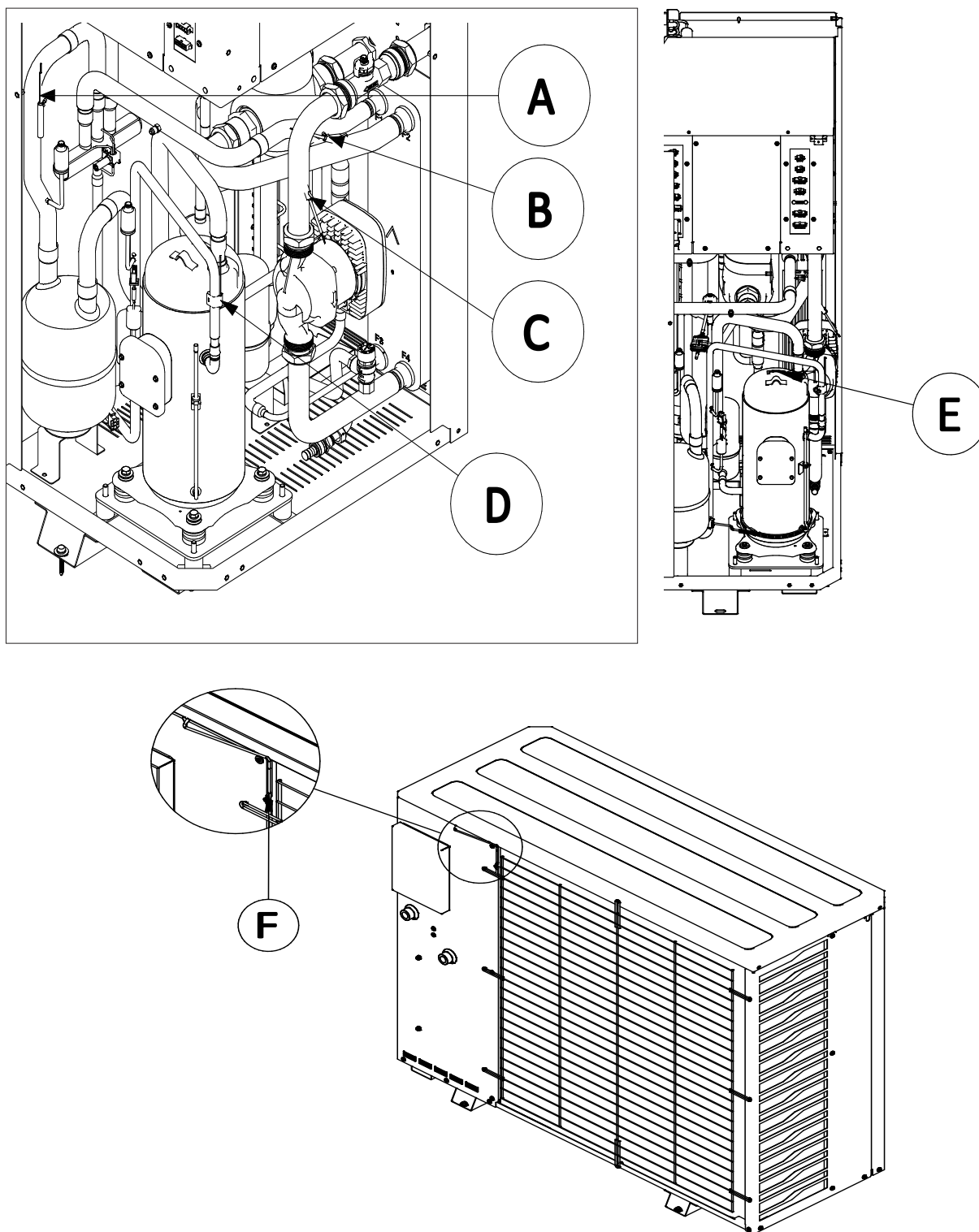

## 2.5. Operating principle

### 2.5.1. Heat production

When the heat pump is operating in heat production mode, other than in the start-up and transition phases, the inlet temperature must not fall below 22°C. A lower value may cause system anomalies, including damage to the compressor. At the same time, the output temperature must not exceed 73°C

Outside this temperature range, malfunctions of the appliance can occur, causing the triggering of safety devices in the most critical cases, especially when such operation at the limits is combined with low flow rates.

### 2.5.2. Operating ranges

This unit is designed to operate within an external air temperature range of between -20°C and +43°C depending on the operating mode. The outlet water temperature depends on the external air temperature, within the limits given in the diagram below.

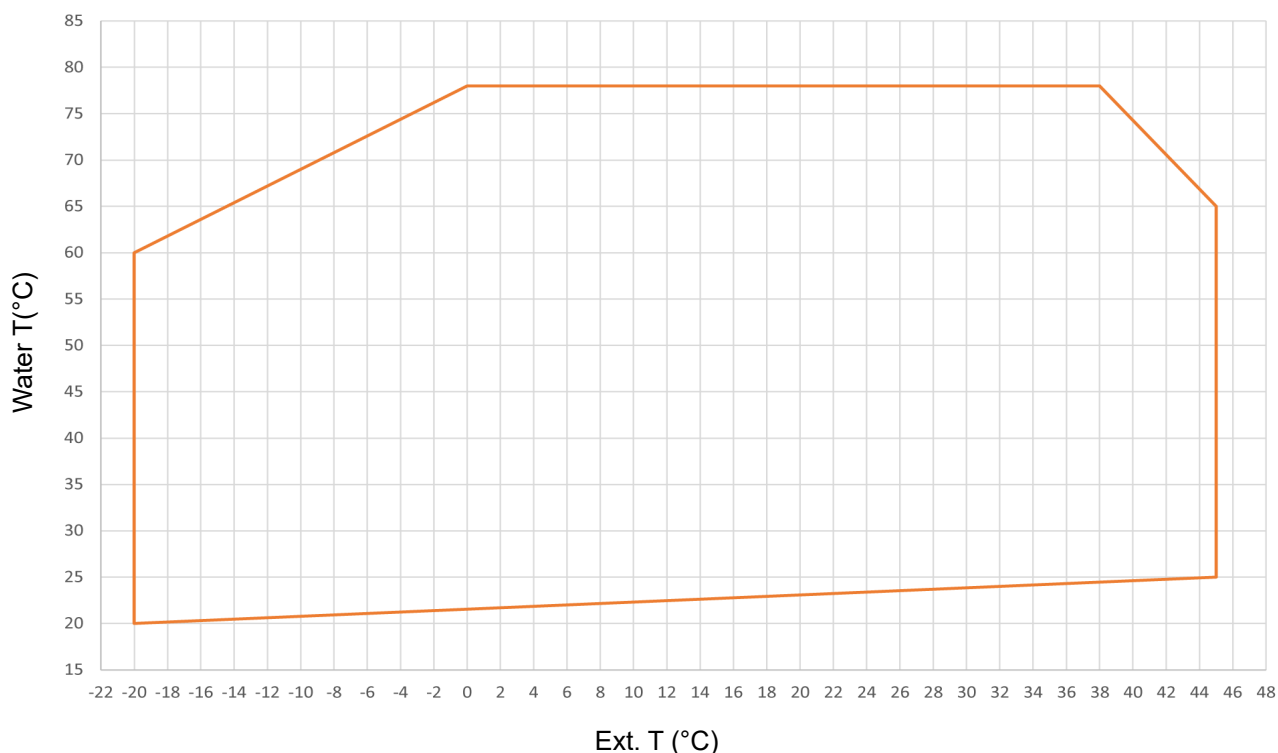

**figure 3 - Temperature limits of the water supplied by the unit in heat pump mode depending on the temperature of the intake air.**

## Water flow to the evaporator

The nominal water flow rate is determined for a temperature difference of 5°C between the inlet and the outlet of the evaporator. The maximum authorised flow rate is that with a temperature difference of 3°C whereas the minimum is that with a temperature difference of 10°C in nominal conditions, as shown on the data sheet.

For more detailed information, the table below indicates the minimum flow rates to the condenser to be guaranteed in order to ensure that it operates correctly according to the model, and the disconnection and restart flow rates of the appliance depending on the flow rate.



### CAUTION:

**Insufficient water flows can cause condensation temperatures that are too high, causing the intervention of the safety devices and the switching off of the unit and, in some extreme cases, severe refrigeration circuit failures.**

Model	23kW	27kW
Minimum flow rate in m <sup>3</sup> /h	1.62	1.90
Maximum flow rate in m <sup>3</sup> /h	5.43	6.37
Threshold* flow rate for cut-off and restart of the HP in m <sup>3</sup> /h.	0,90	1.10

\* When the flow rate falls below the limit indicated (flow rate controller activation threshold), the flow rate controller indicates the alarm 06, which may only be reset when the flow rate controller deactivation threshold is exceeded.



### CAUTION:

**Pay attention to the hydraulic system pressure levels: values that are too low can cause unit malfunctions.**

If the hydraulic system pressure is very low, the flow meter may display an unstable reading. It is therefore recommended to use an automatic filling system or a pressure monitoring system. Monitor water quality § 3.6.5.

It is advisable to periodically check the condition of the degasser, especially if very high temperature differences are noted between the inlet and the outlet on the water side, as the presence of air bubbles in the circuit reduces the available water flow, which changes the flow meter reading.

## 3. INSTALLATION



### CAUTION:

**The outdoor unit and its control units must be installed using the new equipment supplied.**

### 3.1. Lifting and handling

#### 3.1.1. Precautions

Handling must be carried out by qualified personnel, using appropriate equipment for the weight and size of the unit, in compliance with the accident prevention safety rules.

Notes:

- 1) Check the weight on the data label on the unit or in the technical data table.
- 2) Check that the equipment to be used to move the unit is suitable for lifting the unit and maintaining its integrity.
- 3) Before any handling is started, ensure that the unit is balanced and stable.
- 4) Only lift using one of the procedures listed in the following paragraph.
- 5) Check that the unit always remains in the upright position when moving it.
- 6) While moving the unit, check that there are no obstacles that may affect the movement and damage the appliance.

### 3.1.2. Lifting method

The authorised lifting methods are:

- fork lift truck,
- ropes/chains.

Lift progressively and check that the ropes/chains are in the correct position.

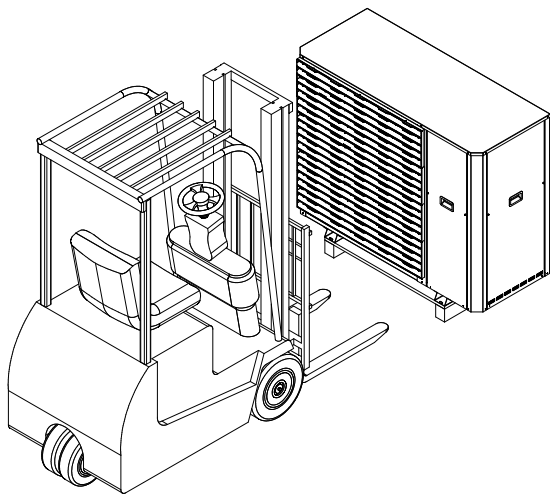

figure 4 - Lifting with a fork lift truck

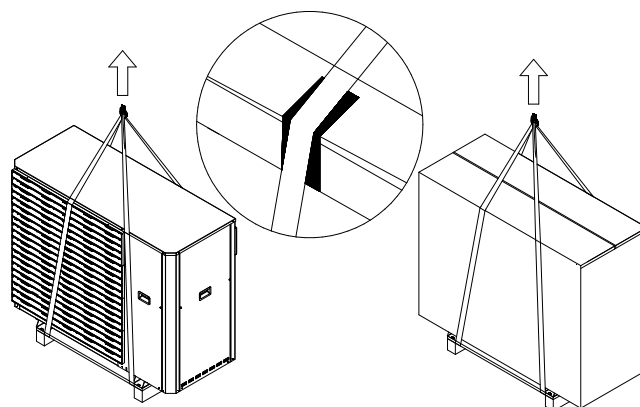
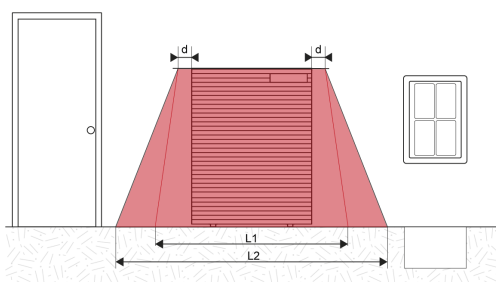

figure 5 - Lifting with ropes/chains

### 3.2. Accessories supplied but not fitted

IHM



It is advisable to place the UI and the disconnecter outside the red zone

### 3.3. Installation

The choice of the position for installation is particularly important insofar as any later movement is a delicate operation requiring the intervention of a qualified person.

Comply with the maximum and minimum distances for the outdoor unit (see next paragraph); the performance and service life guarantees depend on this.

### 3.4. Installing the outdoor unit

#### 3.4.1. Installation precautions

**It is strongly recommended to install the HP0 outdoors.**

**All models of the ECOMOD series have been designed for outdoor installation (see paragraph 3.4.2 for further details). For other locations, there are possibilities with reservations. Please consult the integration guide for further details.**

- Choose a site that is sheltered from strong cold prevailing winds (Mistral, Tramontane, etc.).
- The outdoor unit is made of metal elements that can be subject to corrosion when exposed to particularly aggressive environments, especially the evaporator, which is directly exposed to an external air flow forced by the fan. 3 particularly aggressive environments may be mentioned.



**CAUTION:**

Marine environment: the marine environment is characterised by a high concentration of sodium chloride (salt). It is transported by the sea spray in the immediate vicinity of the coasts, by the fog, or by the sea breeze which can carry particles of salt water far from the coasts, up to several kilometres in the continent.



**CAUTION:**

Industrial environment: industries use or transform chemical elements in their processes: cleaning or surface treatment agents, various combustions (hydrocarbons, coal, incinerations), salting, etc. A list of corrosive elements that can be encountered in this type of environment is provided in the table in Figure 6.



**CAUTION:**

Rural environment: agricultural processes include the spreading of chemical fertilisers, and emissions of potentially aggressive pollutants such as animal waste in livestock farms or gas emissions from agricultural machinery. A few elements to watch for are also shown in the table in Figure 6.

Determining which corrosive elements are present in the environment of an installation is a necessary preliminary step but is not sufficient to define how to protect the unit. It is also necessary to establish if it will be directly and continuously or frequently exposed to aggressive agents.

An observation of the climate and the surrounding terrain will help to define the main wind directions in the area and the distance to which the sea spray or fertilisers will be transported.

A study of the configuration of the buildings is to be carried out to highlight the zones of air recirculation, and the zones exposed to the emissions of pollutants (chimneys, nearby agricultural fields), in particular in the case of installation on a roof. Positioning the heat pump behind a building may be sufficient to protect it from aggressive agents.

Attention, installation behind a wall or under an alcove is not a guarantee of protection against corrosive elements, the shelter must allow ventilation in fresh uncontaminated air to constitute an effective protection against corrosion.

These few tips are not intended to be exhaustive when choosing a unit with or without an anti-corrosive coating (AC).. It is impossible to define this precisely because each installation is unique. However, by taking into account the above-mentioned elements, it is possible to estimate whether the appliance will be installed in exposed conditions or not. In case of doubt, it is preferable to choose a unit with a protective coating, in order to guarantee the longest life for the appliance.

- Do not install the appliance in a passageway.
- For correct operation and an optimal life span of your equipment, it is necessary to have a

quality of water that complies with the general conditions of sale.

- **The appliance must be easily accessible for future installation and maintenance work. If the outdoor unit is installed at a height, arrangements must be made to ensure the safety of the workers (platform with guardrail accessible via available means and in accordance with regulations).**
- Make sure that the passage of hydraulic connections is possible and easy, especially in the case of several heat pumps.
- Take into account free access to the panels and their removal, as well as the elements to be removed from the HP if a part is to be replaced.
- The outdoor unit is weatherproof, but avoid installing it in a place where it may be exposed to dirt or heavy water run-off (under a leaking gutter, under a roof, etc.). Avoid installing the unit in places where water is likely to stagnate or fall, for example from gutters
- The outdoor unit must be raised by at least 50 mm from the ground. Avoid places where snow can accumulate (e.g. corners of buildings with sloping roofs). If the unit is to be installed in areas prone to snowfall, it should be raised by at least 20 cm and at most 150 cm (depending on the average snowfall in the area) to prevent snow from accumulating around the machine.
- 40 cm from the ground (because HP width <1.2m: DTU65-16) if installed on a roof terrace.
- During operation, water (due to the condensation of the water contained in the air) is discharged from the outdoor unit. If the unit is installed on a terrace where there is a risk of frost, a connection for the condensate drainage is required.  
If the appliance is installed in a region where the temperature may fall below 0 °C for long periods, fit the condensate drain hose with a trace heater to prevent it from icing over (see Figure 9 page 38).
- If a water trap is installed, check the efficiency of the condensate drain and provide a trace of the trap.
- Nothing should obstruct the air from circulating through the evaporator and out of the fan.
- The site where the unit is installed must be free of foliage, dust, etc., which could obstruct or cover the heat exchanger.
- Ensure that the appliance does not disturb neighbours or users (noise level, draughts caused, low temperature of the air blown causing a risk of freezing plants in its path).
- It is advisable to create a support slab of suitable size for the unit. However, it is advisable to install anti-vibration mounts between the base frame and the supporting surface, to avoid the transmission of vibrations throughout the building. In the case of a suspended installation, it is necessary to ensure that the wall is constructed of solid brick, concrete, or other material of equivalent characteristics. The wall must be designed to support at least four times (4x) the weight of the unit. Similarly, the supporting surface must be designed to support the weight of the unit. This weight is indicated on the technical label affixed to the machine, and in this manual in the chapter "technical specifications". The support surface must not be inclined in order to ensure the operation of the refrigerant circuit and to avoid tilting of the unit.
- The surface on which the unit is installed must not be smooth, to avoid water/ice deposits, which can be dangerous.
- Provide a gutter or condensate drain.
- **Observe the safety zones to separate the unit from any cavities such as pits, manholes, building entrances or sloping roofs, in which refrigerant might accumulate in the event of a leak.**
- It is very important to avoid recirculation between suction and discharge, otherwise the performance of the unit will deteriorate or even interrupt normal operation.
- In the case of a cascade of heat pumps, it is forbidden to place the fan of one unit facing the evaporator (air inlet) of another unit.



Type	Corrosive product	Industries / risk zones						
		Paper / wood	Incinerators & other combustions	Cleaning	Salt extraction	Swimming pools	Treatment plants	Agriculture & fertiliser manufacturers
Oxides	Nitrogen oxides (NOX)	x	x				x	
	Sulphur oxides (SxOy)	x	x					
	Carbon oxides	x	x					
Volatile gases or liquids	Sulphurs	x					x	x
	Hydrogen fluoride		x					x
	Ozone		x					x
	Methane						x	
Volatile Organic Compounds (VOC)		x	x				x	
Hydrocarbons	Terpenes	x						
Alcohols	Methanol	x						
	Other alcohols	x						
Acids	Phenols	x						
	Sulphuric acid		x					x
	Hydrochloric acid		x					
	Hydrofluoric acid							x
	Phosphoric acid							x
	Fluorosilicic acid							x
Particles	Micro-particles	x	x					
	Ash	x	x					
Other	Nitrates		x					x
	Sulphates		x			x		x
	Chlorine compounds			x	x	x	x	
	Bromides				x	x		
	Ammonia						x	x
	Phosphate				x			

**figure 6 - List (non exhaustive) of the corrosive products encountered in different environments**

It is recommended that you conduct a noise pollution risk assessment. This should take into account the residual noise without the heat pump, the machine data, the place of installation, the distance to the point of measurement, without this list being exhaustive.

The levels of normative requirements being different for day and night.

In order to reduce the risks, it is advisable to study the transmission of vibrations from the machine to the building, as well as the pipes, the reverberation, etc.

### 3.4.1.1. Principle of reflection of emitted noise.

Inner courtyards and closed corners should be avoided where possible.

The volume also has an impact, for example a small inner courtyard leads to greater reflection.

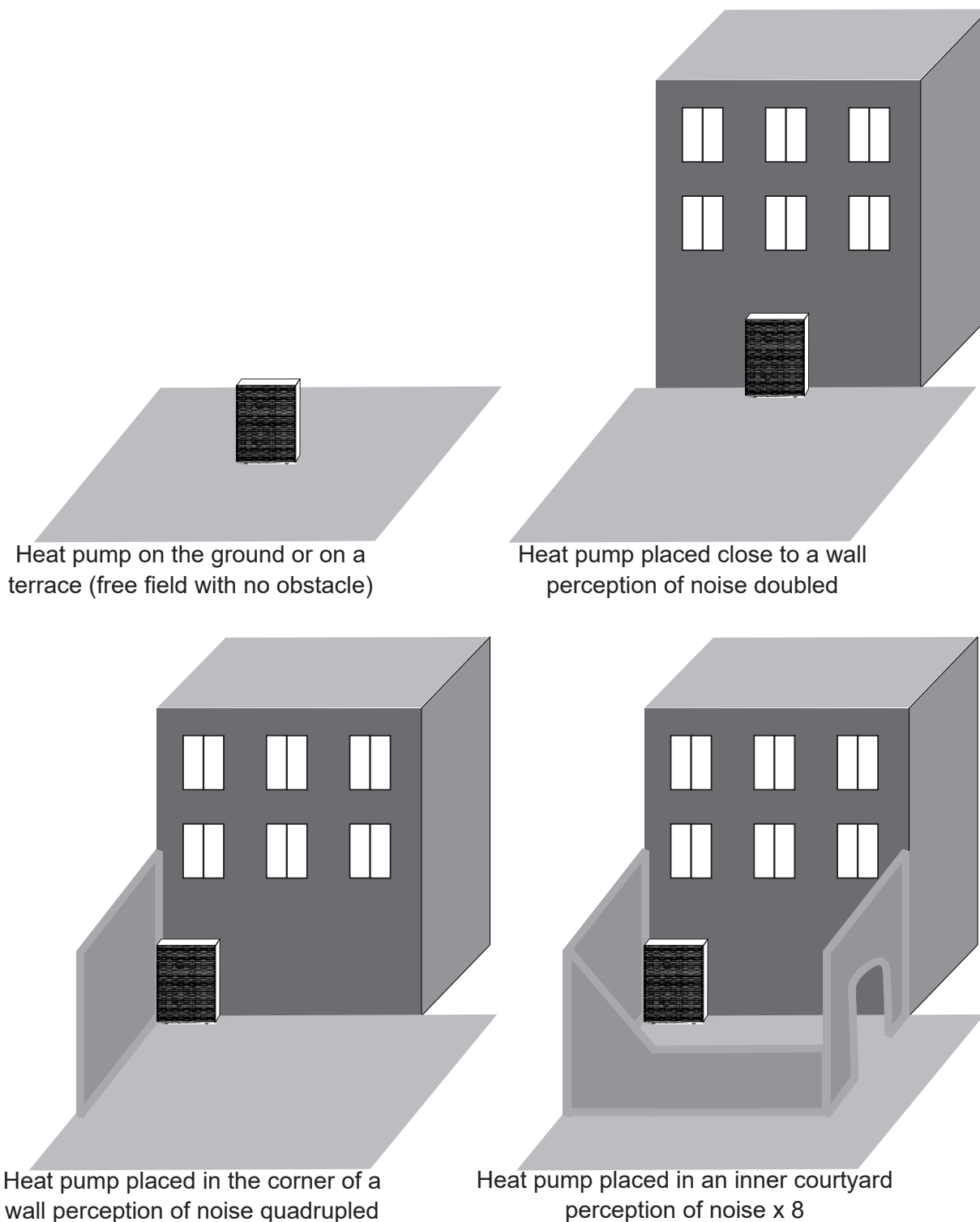

### 3.4.2. Minimum technical clearances

- By following the installation precautions, it is absolutely essential to ensure the following minimum service clearances are respected. The distances B1 and B2 are required for the maintenance of the unit. The other distances are required for the unit to operate correctly.

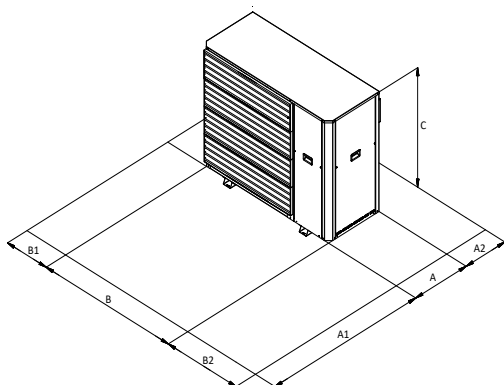

Model	A1	A2	B1	B2
23kW	mm 1500	500	400	400
27kW	mm 1500	500	400	400

figure 7 - Minimum installation clearances around the outdoor unit



**CAUTION:**

Do not obstruct or cover the ventilation openings on the top cover.

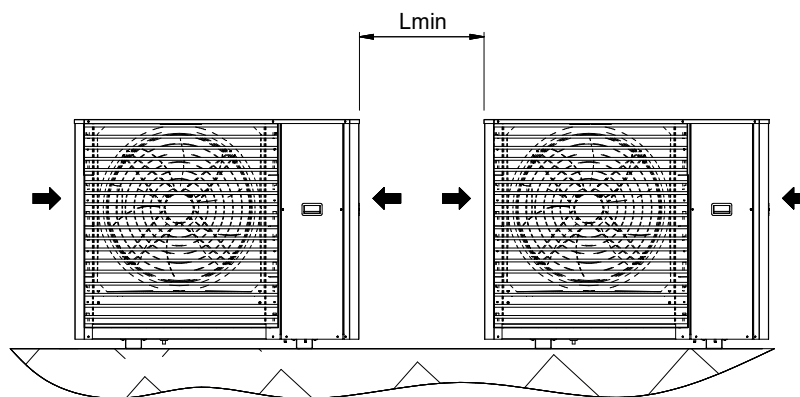

- If units are positioned side by side, the minimum distance Lmin to be respected between them is 1 m.
- The minimum clearances (figure 7 above) must be respected regardless of the installation to guarantee the performances and safety of the unit.
- It is designed to be installed outdoors, in open air. A shelter or alcove in which at least one of the longest walls is open to the outside air by louvres having a free area of 75% and covering at least 80% of the wall (or the equivalent if more than one wall is open to the outside air), is considered to be open to the outside air.
- In general, any recycling of the air should be avoided as this will have an impact on the performances of the heat pump.
- In the event of an accidental leak, it must be possible to evacuate the refrigerant.
- The unit is designed to be installed outdoors. If installation under an alcove cannot be avoided, be sure to follow the instructions below in order to limit a drop in performance and air recycling.

- Installation under a shelter or an alcove causes the unit's performances to drop. To limit this drop, an alcove must have 2 open opposite faces in the axis of the fan. If due to location, the open sides cannot comply with this rule, provide a removable enclosure around the unit to separate the air inlet and outlet. A gutter or drain should be installed to drain condensation water (see Figure 9 page 38).
- If grilles are installed on the open sides of the alcove, they must have an effective (open) surface area limiting the pressure drop to <math><5\text{Pa}</math> to allow all installed heat pumps to discharge the required flow rate (see flow rate in the table in paragraph 2.3.1).
- The Ideal Heating cannot be held responsible for any drop in performances of the unit if these recommendations are not respected.

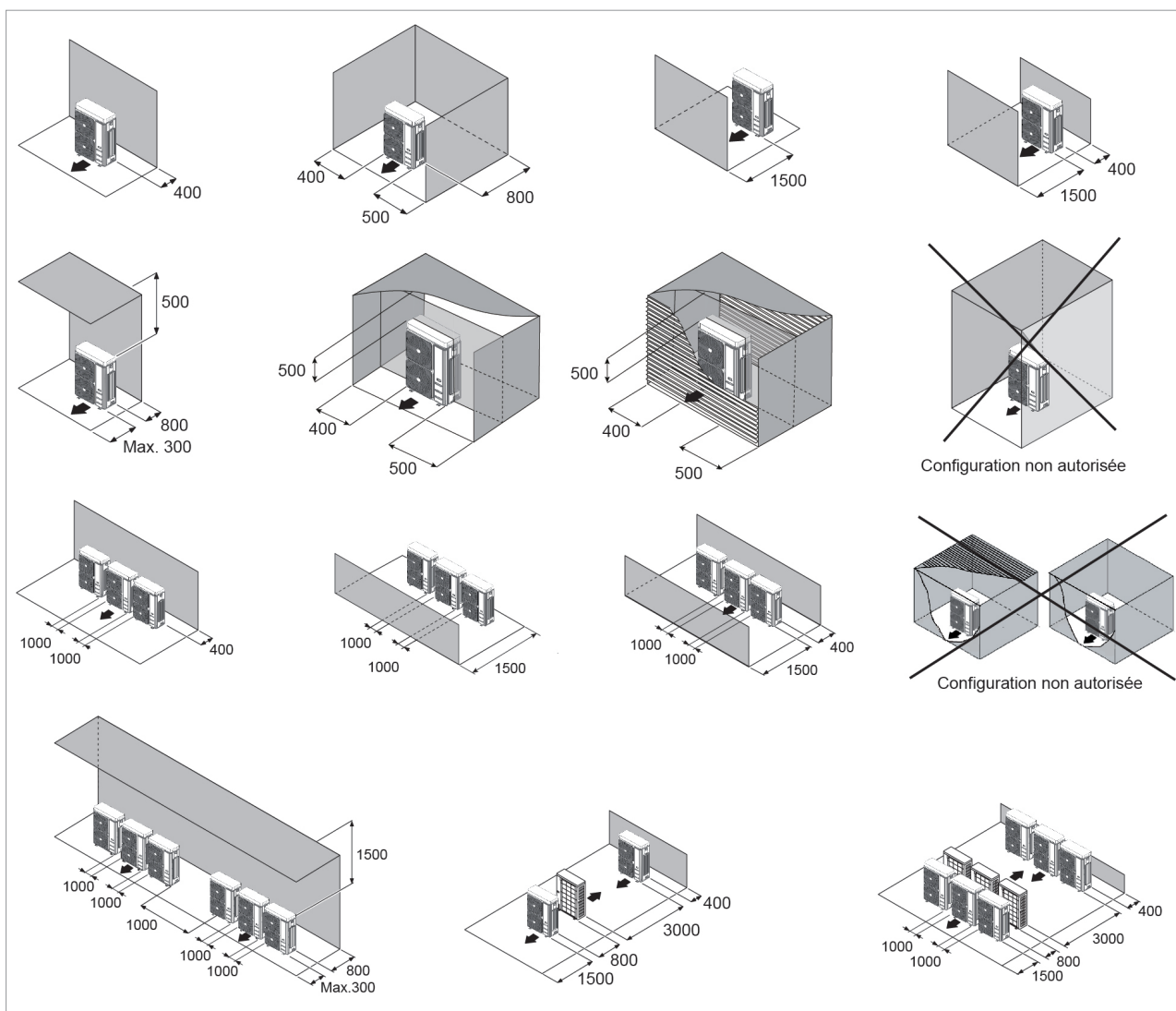

### 3.4.3. Condensate drainage system

All of the ECOMOD units have been designed so that the base of the unit acts as a condensate drainage tray. A plastic connector is supplied and is to be installed under the base, to connect a hose to channel the condensation water.

Each unit is therefore equipped with a hole on the base of the hydronic kit on the battery side for the evacuation of any condensation that may penetrate through the pipes of the hydraulic system. As these pipes are well insulated, the production of condensation is minimised and it is therefore not necessary to connect a drainage pipe to this connection.

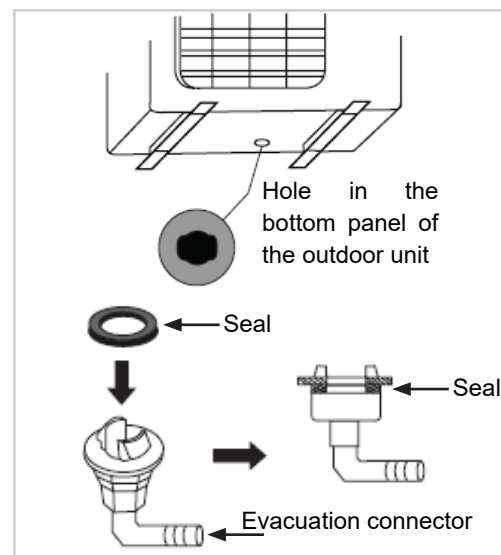

figure 8 - Condensate evacuation



#### CAUTION:

More especially in the coldest regions, we recommend installing supports to raise the unit to prevent ice from forming under the unit and damaging it.

In the event of a leak, refrigerant gas can escape from the unit through the hole in the base panel. It is therefore recommended that condensate drainage be directed to an open area near the machine (in the danger zone defined in Chapter 2.4.3). If the appliance is installed on the ground, it is also possible to channel the condensates into a bed of rubble or gravel for drainage. For a typical open field installation, please refer to the images below:

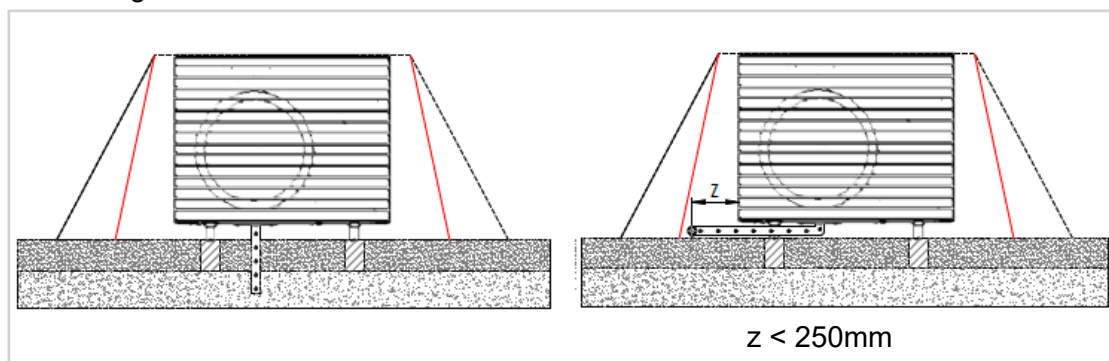

figure 9 - Evacuation dans un lit de gravats ou de gravier



#### CAUTION:

Do not block the hole in the base panel for condensate drainage.



#### CAUTION:

For geographical areas where the outside air temperature can be below  $0^{\circ}\text{C}$ , a condensate drain pipe fitted with a heating element may be installed to prevent the condensation from freezing. In this case, the heating element must be compatible with the use of R290 refrigerant gas.

### 3.5. Installing the control unit

The Navistem T3100 control unit is supplied separately from the heat pump, with a specific installation guide inside its packaging. Refer to this guide to connect this unit.

### 3.6. Hydraulic connections

#### 3.6.1. Accessories to be connected to the external unit

- In the same way, the hydraulic connections must comply with good engineering practices according to the regulations in force.
- Before making the hydraulic connections, the supply pipes must be cleaned to avoid contaminating the tank with metal or other types of particles.
- The Plumbing DTU 60.1 (NFP 40-201) must be respected.
- Check when hot that the pressure does not exceed the service pressure.
- **Recommendations:** for regions where the water is hard, the use of a water softener does not imply any change in our Guarantee, provided that the softener is adjusted in line with trade standards, and is checked and maintained regularly (Decree No. 2001-1220 of 20 December 2011).
- **The water hardness must be greater than 8°f and less than 15.1°f.**

#### 3.6.2. General Information

The hydraulic connections must comply with the national or local regulations; the pipes may be made of steel or galvanised steel. Flexible hoses may be used if their diameter is larger. The dimensions of the pipes must be chosen carefully to suit the nominal water flow rate of the appliance and the pressure drops in the hydraulic circuit. All of the hydraulic connections must be insulated with closed-cell insulation of adequate thickness. The unit must be connected to the pipes with new flexible hoses, not ones that have already been used. We recommend fitting the following components in the hydraulic circuit:

- Thermometer with sensor for reading the temperature in the circuit.
- Manual valves to isolate the heat pump from the hydraulic circuit.
- Y-shaped metal filter and filter-settler (installed on the system return pipe) with a metal mesh not larger than 1mm.
- Loading unit and discharge valve if required
- Anti-vibration sleeve to prevent the transmission of noise pollution via the pipes
- Check valve on the HC return to prevent possible dispersion of the R290 fluid in case of migration into the heating circuit.



**CAUTION:**

When choosing the size of the pipes, make sure that the maximum pressure drop of the system as stated in the technical data in paragraph 2.3.1 is not exceeded (see useful head).

Always connect the pipes to the connections using the wrench-to-wrench system.

Make a suitable drain for the safety valve.

It is the installer's responsibility to check that the expansion vessel is suitable for the actual capacity of the system.

The system's return pipe must be on the "Water inlet" label, otherwise the evaporator may freeze.



**CAUTION:**

A metal filter must be fitted (with a mesh size not exceeding 1000 µm) as well as a T connector on the return pipe of the system labelled "Water IN" (water inlet). If the flow rate switch is tampered with or modified, or if the metal filter and filter-settler are not fitted to the system, the warranty is immediately void. The filter and filter-decanter must be kept clean, so please always ensure they are clean after installation of the appliance and check them periodically.

All units are fitted with a flow rate controller (factory-fitted). If the flow rate controller is modified or removed, or if the water filter and filter-settler are not fitted on the unit, the warranty is immediately void. Refer to the wiring diagram supplied with the appliance for the connection of the flow rate controller. Never shunt the flow rate controller connections in the terminal block.

The heating system connected to this unit must be installed in compliance with the standard EN-12828.

### 3.6.2.1. Minimum water content and volumes of the hydraulic circuits

The table shows the minimum water content of the system that is recommended for the unit. The volume of the hydraulic circuit is also shown. Ensure the proper operation of the heat pump, this minimum content must be observed. Take into account the water volume of the primary circuit piping, size the heat flywheel to attain the volume shown.

R290 model	23Kw	27Kw
Minimum water content of the system (L)	175	200
Volume of the hydraulic circuit (L)	3.6	4.0

### 3.6.3. Manometric head available

The circulation pump is built into the heat pump. The hydraulic pressure available at the outlet of the outdoor unit is shown in the graph below.

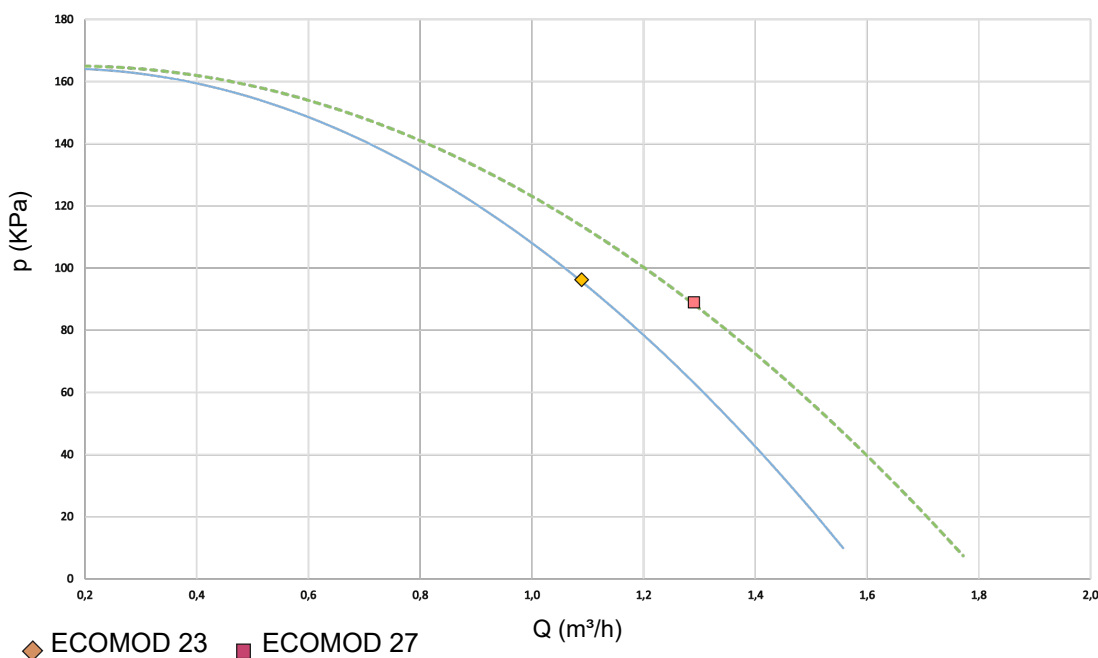

### 3.6.4. Primary circuit flow rate control



**CAUTION:**

Managing the primary circuit flow rate is essential to ensure product performance and service life. The flow setting value must be adapted to suit the application. Refer to the Navistem T3100 (control unit) manual and the sizing study.

It is essential to install adjustment valves on the HP outlet pipe (not supplied), refer to the diagram.

When a cascade installation is used, the flow must be balanced between all units. We recommend performing this balancing using balancing valves so that individual flow levels can be measured over time.



**CAUTION:**

Flow adjustment and checking are the responsibility of the installer/operator and will not be performed by Ideal Heating. When the system is commissioned, a balance check will be required by Ideal Heating. If no check is performed, commissioning will be refused.



### 3.6.5. Water quality

- **Preparing the water system before putting the heat pump into service**

For any installation (new or renovation), the water pipes must be thoroughly cleaned. The purpose of this initial cleaning is to eliminate germs and residue that can cause deposits to form.

In new installations in particular, residue from grease, oxidised metal, and even copper micro-deposits must be scrupulously removed.

In renovated installations, cleaning should focus on removing sludge and the products of corrosion formed when the unit was last in operation.

There are two types of methods for cleaning and removing sludge: a high intensity approach that takes a few hours, and a slower, more gradual approach that takes several weeks. In the first case, it is essential to clean before connecting the new heat pump. In the second case, fitting a filter on the heat pump return will capture any loose deposits.

The cleaning performed prior to installation improves performance, reduces energy consumption, and resists scaling and corrosion on the unit. A professional (water treatment) should carry out the cleaning.

- **Protecting the unit against scaling**

Water naturally contains dissolved calcium ions and carbonates that cause scaling (calcium carbonate) to form. To prevent excessive deposits, take precautions with regard to the water used to fill the unit:  $8^{\circ}\text{f} < \text{TH} < 15.1^{\circ}\text{f}$ .

When the installation contains softener, the equipment must be inspected frequently to check it does not discharge any chlorine-rich water into the network: the chlorine concentration must always remain below 50 ppm.

To prevent the build-up of calcium deposits (such as on exchange surfaces), the unit should be brought into service slowly, starting by operating at a low power with high primary water flow.

Water must be added during the life of the heat pump. The new water adds scaling to the water system. To avoid this, it is important to check that the hardness of the water added does not exceed  $\text{TH} < 5^{\circ}\text{f}$ . The amount of fill water plus the amount of make-up water added during the life of the unit should not be more than three times the water capacity of the heating system. If this guideline is not followed, complete cleaning (descaling and cleaning) is necessary.

If it has excessive scaling, the unit's settings for operation and for water treatment must be adjusted.

Adding a large amount of untreated water always contributes a significant amount of scaling. To monitor this and to detect problems, a system water meter must be installed. When carrying out work on the installation, do not drain it completely. Only the sections of the circuit concerned need to be drained.

- **Protecting the heat pumps against corrosion**

Corrosion can affect the iron components used in heat pumps and heating systems,, directly related to the presence of oxygen in the water heater's water. Dissolved oxygen that enters the unit when it is being filled for the first time reacts with the equipment materials and quickly disappears. Without refreshing the oxygen through significant contributions of water, the unit might not experience any damage whatsoever. However, it is important to follow the sizing rules and installation guidelines in order to prevent oxygen from continuously flowing into the heating water. From these rules, we have:

- Preferably an expansion vessel with a membrane rather than an open expansion vessel that allows direct passage,

- Internal pressure with the unit of more than 1 bar cold.

- Remove leaky (permeable) components that are letting out more gas than as if they were sealed. If the guidelines above are followed, the unit's system water has the proper characteristics to last a long time:  $7.5 < \text{pH} < 9$  with a dissolved oxygen concentration of  $< 0.1$  ppm



If there is a chance that oxygen could enter the unit, you must take additional precautions. Adding an oxygen scavenger (ex. sodium sulphite) is highly recommended. We recommend directing any water treatment questions to specialists, which can provide the appropriate treatment based on the characteristics of the installation, and a monitoring agreement with a guarantee as to the results.

In the case of a unit where the water is in contact with heterogeneous materials, for example, if there is any copper or aluminium, appropriate treatment is recommended to guarantee a long lifetime for the unit. In most cases, this treatment involves adding chemical solution corrosion inhibitors to the installation. We recommend contacting water treatment specialists.

#### • Unit monitoring

If the recommendations listed above (new installation or renovation) have been followed, the unit monitoring is limited to:

- checking the amount of make-up water (fill water volume + make-up water volume < 3 times the volume of the unit).
- checking the pH level (stable or slightly increasing),
- checking the total hardness of the water (TH stable or slightly decreasing)

We recommend monitoring these parameters two to three times a year. It should be noted that the “make up water quantity” parameter is vital for a long lifetime for the unit.

If any of these three above parameters deviates from the above recommendations, refer to a water treatment specialist to correct the problem.

#### • Setting up a filtration system

A filtration system on the back of the heat pump is obligatory in order to remove suspended particles from the unit.

### 3.6.6. Connecting water supply

Check that the system is stopped, with the general switch in position 0.

Add water until the pressure of the hydraulic circuit reaches 2 bar. Switch the on again and then apply the purge process (see § 3.6.6.3). The internal drain valve is automatic, run the pump to readjust the pressure.

Check that there are no leaks by using the “degassing” function of the regulation.

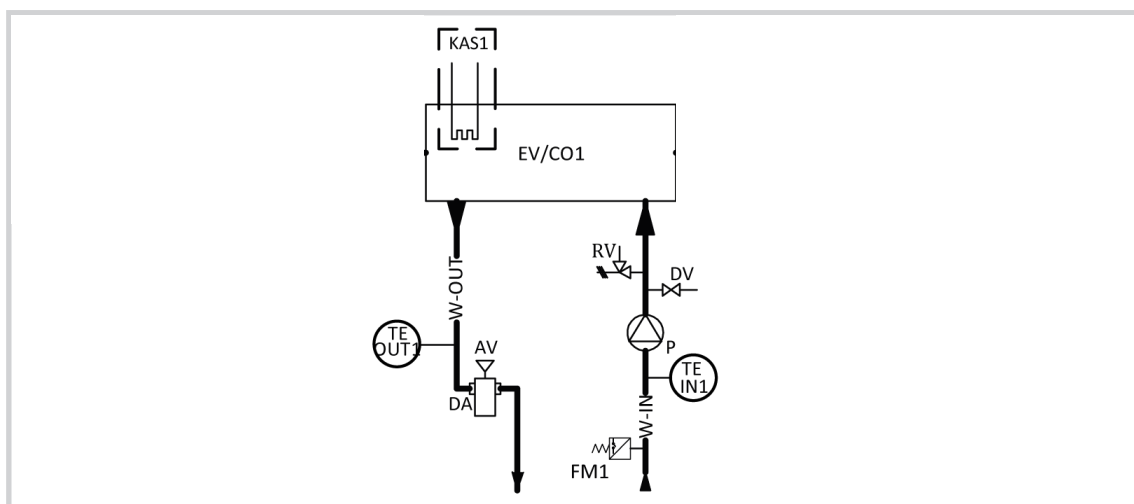

figure 10 - Hydraulic circuit

### 3.6.6.1. Precautions when connecting the water supply

- Supervise all of the operations for connecting the water supply and filling.
- Before connecting the water supply and filling the system, disconnect the electrical power supply to the units.
- The connection of the water supply and filling of the installation must always be carried out under controlled pressure conditions (2 bar for commissioning and min. 1 bar in operation). Ensure that a pressure reducer and a safety valve have been fitted on the loading/reintegration line.
- The water in the supply/filling line must be filtered properly beforehand to remove all impurities and suspended particles. Ensure that a removable screen filter and filter-settler are installed.
- Periodically check and evacuate the air that accumulates in the system.
- Fit an automatic air vent at the highest point of the installation.
- Check that the cap on the air vent of the degasser always remains open.

### 3.6.6.2. Automatic air vent

The unit is equipped with a high efficiency degasser that continuously captures and removes air and any refrigerant gas that may accumulate in the hydraulic circuit, thus avoiding adverse effects such as premature corrosion and wear, reduced efficiency and exchange performance, and possible contamination of the water by the R290 gas. The exhaust capacity is very high, with automatic expulsion of gases down to the microbubble level.



**INFORMATION:**

If you inject products with a low tendency to foam into the hydraulic circuit, this could reduce the effectiveness of the degasser.



**CAUTION:**

Make sure that the fittings on the appliance are hydraulically tight. Do not exert mechanical stress on the threads of the fittings during installation, as this may damage the component.

**FOR INFORMATION:**

- The moving parts that control ventilation can be accessed by removing the top cover.

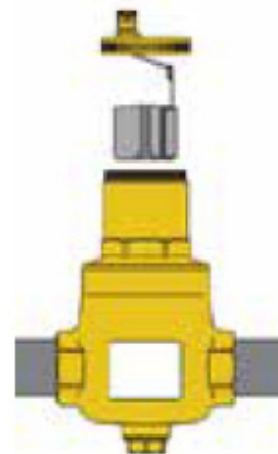

Use products with a low tendency to foam, which could completely cancel the degassing effect and damage the system.

- For possible cleaning, after drawing off water from the system, unscrew the part of the body containing the venting valve, to which the separator element is attached. The above-mentioned part is not removable.



**CAUTION:**

Anyone working on the HP must be trained and equipped to handle the R290

### 3.6.6.3. Degassing function

This function allows you to manually activate the HP circulation pump to perform a purge of the system.

To activate purge mode:

- Home screen in OFF mode

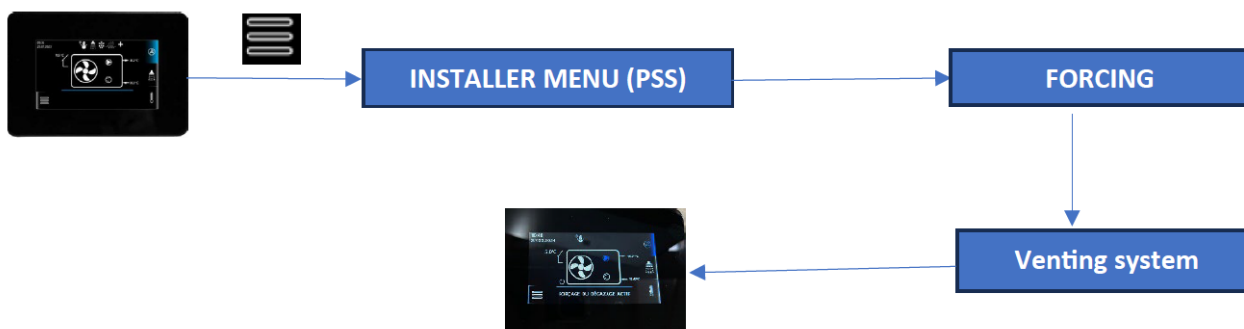

The circulator is activated for 7 minutes, then switches off. You can exit the system drain cycle manually.

To deactivate drain mode:

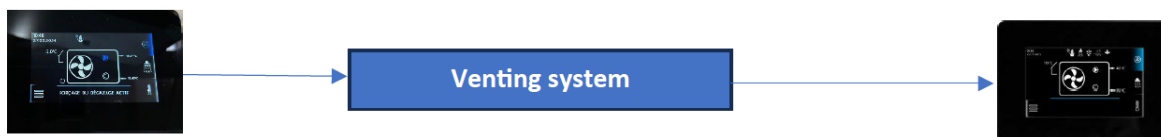

**CAUTION:**

During this function, the flow rate controller's alarm is deactivated; the maintenance technician must guarantee the water content inside the installation.

### 3.6.7. PROCEDURE FOR CHARGING THE MACHINE

The unit is delivered already filled with refrigerant gas. If it is necessary to recharge it, after maintenance or after a leak, follow the steps below in the order indicated:

- Before undertaking any work, a risk analysis should be performed and the work area should be delimited. Check that there are no potential ignition sources in the appliance. The minimum space around the unit, which must not include manholes, drains or other low points where refrigerant gas can settle, must be greater than the danger zone (> 3m see Chapter 2.4.3. Safety zone dimensions: (Y/Y1 distance);
- Display warning signs and prevent access by unauthorised personnel;
- Use the PPE indicated in this manual and the appropriate personal equipment for the work to be carried out.

This equipment includes:

- Explosimeter, to check for the presence of hydrocarbons in the environment (to be used before and during work on the system).
  - Hoses and pressure gauges suitable for R290 and free of parasitic oil (see § 2.3.1)
  - Approved non-sparking equipment.
  - ATEX retractor if necessary.
  - Shoes (ESD).
  - Portable R290 detector.
  - Valve fittings for minimum emissions.
  - Extinguisher
  - ATEX fan
  - ATEX scale
- Remove the Schrader valve caps using a backup wrench.

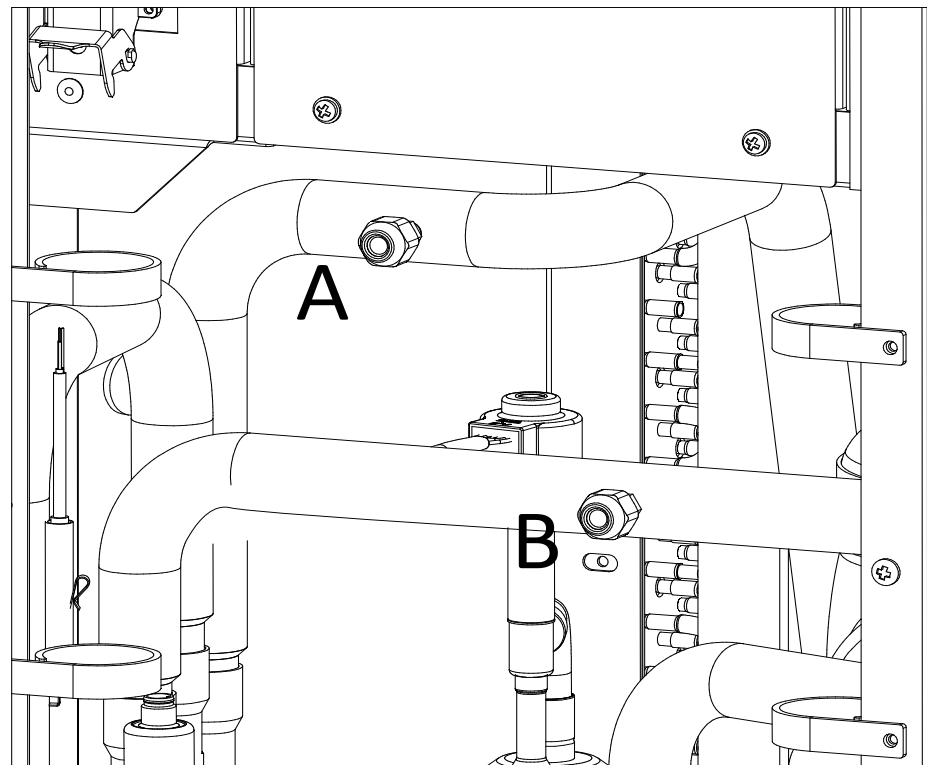

- Connect two hoses to the charging sockets (positions A and B in the previous image) of the circuit and recover the totality of the refrigerant gas. Use a suitable recovery machine (ATEX). In order not to contaminate the recovered gas, retrieve the equipment by vacuuming the pipes and the recipient. Check the condition of seals and filters frequently. It is recommended that the shell be removed using a shell extractor to significantly reduce system suction and charging times;
- Flush the circuit by introducing nitrogen and raising the pressure to 4-5 bar. Expel the nitrogen from the appliance keeping it away from heat sources, ignition points, wells and other possible stagnation points;
- Create a vacuum in the system by reaching an absolute pressure value not exceeding 200 Pa. At this point, use a fan (ATEX) to avoid stagnation of refrigerant gas in the working environment. Ensure that the air flow is directed to an area free of ignition sources;
- Perform this rinse and evacuation cycle at least three times;
- Evacuate the circuit. The evacuation cycle shall consist of an evacuation phase followed by a rising phase, during which the system is allowed to reach equilibrium. The absolute pressure at the end of this process must not exceed 150 Pa. To ensure the best performance of the machine, the evacuation process must be carried out with care and precision;
- Before evacuating, ensure that the pump oil used to create the vacuum is clear and free of bubbles to prevent non-condensable gases or other particles from entering the system's circuit. Use an ATEX vacuum pump;
- Connect a hose to the charging socket of the circuit and charge the refrigerant gas carefully and slowly. Do not charge more gas than necessary: the R290 gas charge must be equal to that indicated in the data sheets. Use calibrated scales (ATEX) with a reading sensitivity of at least one tenth of a gram. If available, the use of heating blankets (ATEX) for bottles is also recommended to speed up the filling of the circuit;
- Once the desired charge has been completed, do not forget to reinsert the new dedicated R290 shell into the Schrader valve, tighten the Schrader cap according to the recommended tightening torque (see label) using a backup wrench and disconnect the device used;
- Check the system for leaks by checking for refrigerant gas leaks using a suitable detector.
- Once charging is complete, observe the pressure/temperature relationship to ensure that there are no non-condensable gases.

Failure to comply with the rules set forth in this manual may result in:

- machine malfunctions and loss of performance;
- leaks of refrigerant gas, which may form an explosion-risk area;
- damage to components or pipes (e.g. freezing).



**CAUTION:**

**All charging/discharging of the machine must be carried out by QUALIFIED PERSONNEL (IEC 60335-2-40 Annex HH).**



**CAUTION:**

**During charging/discharging operations, there is always a risk of refrigerant gas leaking and thus of flammable atmospheres forming. Extreme care must be taken to ensure that no refrigerant gases are present in the environment before and during work.**

### 3.7. Raccordements électriques



**DANGER:**

Ensure that the general electrical power supply has been switched off before starting any repair work.



**CAUTION:**

The protective earth conductor must be longer than the phase and neutral conductors. Furthermore, the main earth conductor and the power supply conductors must have a double attachment very close to their connections.

The electrical panel is located under the cover. The minimum spaces indicated in paragraph 3.4.2 must be respected for the electrical connections.

The installer must fit a dedicated circuit breaker upstream of the electrical connections of the appliance (main circuit breaker).

The supply voltage must be definitive and must not vary, in which case contact the power supplier. The power supply must respect the mentioned limits, otherwise the warranty is immediately void.

If the power cable is damaged, it must be replaced by qualified personnel, in order to prevent any risk.

Any appliances located nearby may cause/suffer electromagnetic disturbances to/from the unit. Be aware of this risk on the installation site. We recommend powering the unit electrically with an adequate line and protections and to use independent cable trays.

The flow meter must ALWAYS be connected as indicated in the wiring diagram. Never shunt the flow meter connections in the terminal block. The warranty will be void if the flow meter connections have been modified or connected incorrectly.

All electrical components are designed to operate in an environment where R290 gas is present. Any damage, alteration or modification may result in a fire hazard.

Do not touch the cable attachment. Do not disconnect the connectors from the electrical cabinet.

Refer to the specific instructions for the wiring of the Navistem T3100

#### 3.7.1. General remarks on electrical connections

Check that the electrical power supply complies with the nominal characteristics of the appliance (voltage, phases, frequency) as stated on the data plate located on the side panel of the appliance. The electrical connection must comply with the electrical wiring diagram of the appliance and local and international regulations (fit a main circuit breaker, and differential circuit breakers for each line, and earth installation adequately, etc.).

The electrical installation must be made in accordance with regulations NFC 15-100.

### 3.7.2. Accessing the electrical panel and the user board

The procedure for accessing the electrical panel and the user board is illustrated below. To access the electrical panel, follow the instructions below:

1. Remove the two component compartment access panels by loosening the screws as indicated in figure 1.
2. To access the electrical panel, remove the panels by loosening the screws as indicated in figure 2.

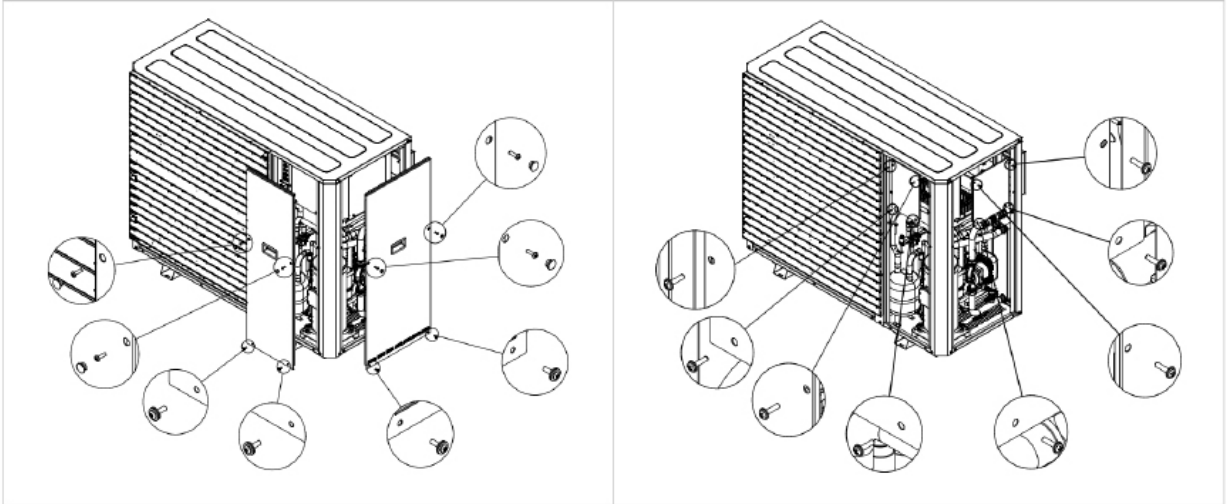

To access the user board, proceed as follows

- Unscrew the M4 screw (number 1) using a Phillips screwdriver.
- Unhook the box by pulling it first upwards (2) and then outwards (3).

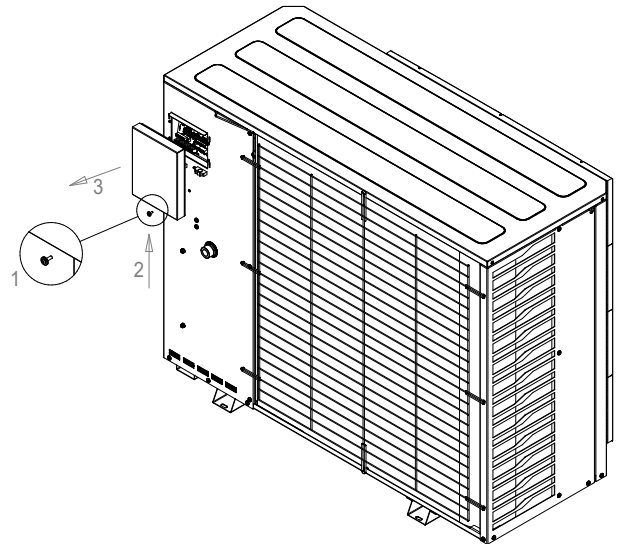

#### CAUTION:

All of the installation operations must be carried out when the heat pump is stopped, and after disconnecting the electrical power supply.

These operations must only be carried out by **QUALIFIED PERSONNEL**.

When the work is complete, refit all of the covers removed with their screws and seals (if present).



### 3.7.3. Current source



**CAUTION:**

**Electrical connections must only be carried out by QUALIFIED PERSONNEL, in compliance with the legislation in force.**

**Ensure that an adequate earth connection is installed, as inadequate earthing can cause electrical shocks. The manufacturer cannot be held responsible for damage caused by ineffective or absence of earthing.**

**Do not use a temporary power supply or construction kit.**

The ratings and dimensions of the power cables, electrical protections and line fuses must comply with the indications of the unit’s wiring diagram and the electrical data of the technical specifications table (see paragraph 2.3.1)).

Use a dedicated power line, do not power the appliance via a line to which other users are connected. Securely fasten the power cables and make sure they do not come into contact with sharp corners. Use double-insulated cables with copper wires.

The earth connection should be made first during the connection phase and vice versa, it should be removed last when the unit is disconnected. If the power cable comes loose, make sure that the active conductors are powered before the earth wire.

A proximity switch with adequate breaking capacity must be installed on the supply line, with contact separation for all poles.

This switch must be close to the HP but outside the danger zone.

A dedicated C-curve circuit breaker must be installed from the line start in the electrical panel.

This circuit breaker must be rated higher than the maximum current allowed by the outdoor unit, and have a breaking capacity greater than the maximum short-circuit current from the upstream power supply (main low voltage distribution panel or other).

A main switch or cut-off device with adequate breaking capacity and contact separation for all poles must be installed on the supply line. The earth fault circuit breaker must be compatible with the inverters, we recommend fitting a type B differential switch, as fitting a different type of switch could lead to unwanted tripping

The following table shows the recommended cable sections for a maximum length of 30 m. In all cases, depending on the type of installation, the physical location and the length of the cables (under or over 30 m), the electrical system installer must make the appropriate choice.

Electrical power supply	Models	Recommended cable section (Max. length 30 m)	Max. absorbed current (A)	Recommended tightening torque:
400V / 3ph+N	ECOMOD 23 kW	5G6 mm <sup>2</sup>	19	N/L/L2/L3/PE : 1 Nm
400V / 3ph+N	ECOMOD 27 kW	5G6 mm <sup>2</sup>	22	N/L/L2/L3/PE : 1 Nm

The units comply with electromagnetic compatibility specifications, but the electrical installation designer must still make the appropriate assessments to ensure there is no interference.

Install a differential magnetothermal switch that is sensitive to all type-B currents (intervention threshold 30mA, breaking capacity 4.5kA).





### 3.7.4. Connecting the control unit

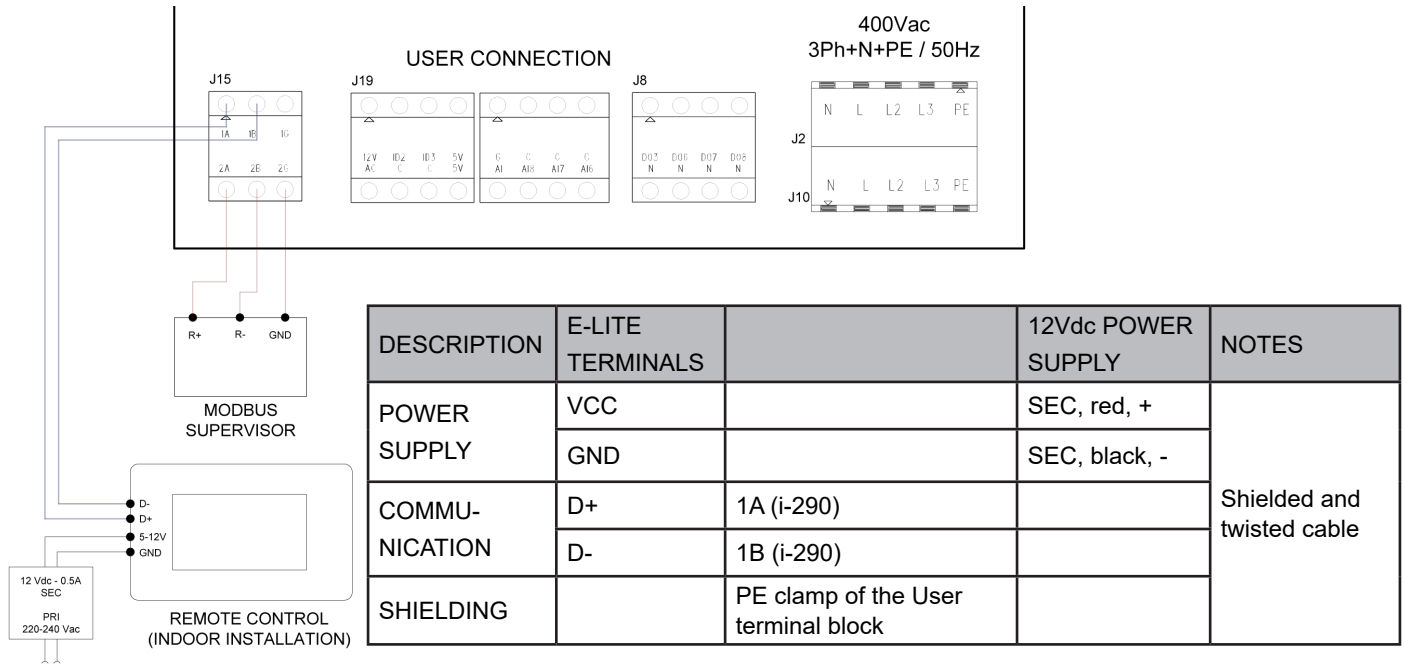

Two connection cables are required between chiller unit or heat pump and e-Lite remote control:

- 5X1mm2 twisted and shielded cable for Modbus communication D+/D-, PE, and 12Vdc power supply, which is included in the box.

NB: The shield of the cable must be connected to PE in both of its ends.

### 3.7.5. Bornier utilisateur

The terminal board is located beneath the cover of the machine. To access it, refer to the chapter 3.7.2. The board must be connected in accordance with the notes below. The connections shown below are standard.



**CAUTION:**

It is important to separate high voltage cables from very low voltage cables

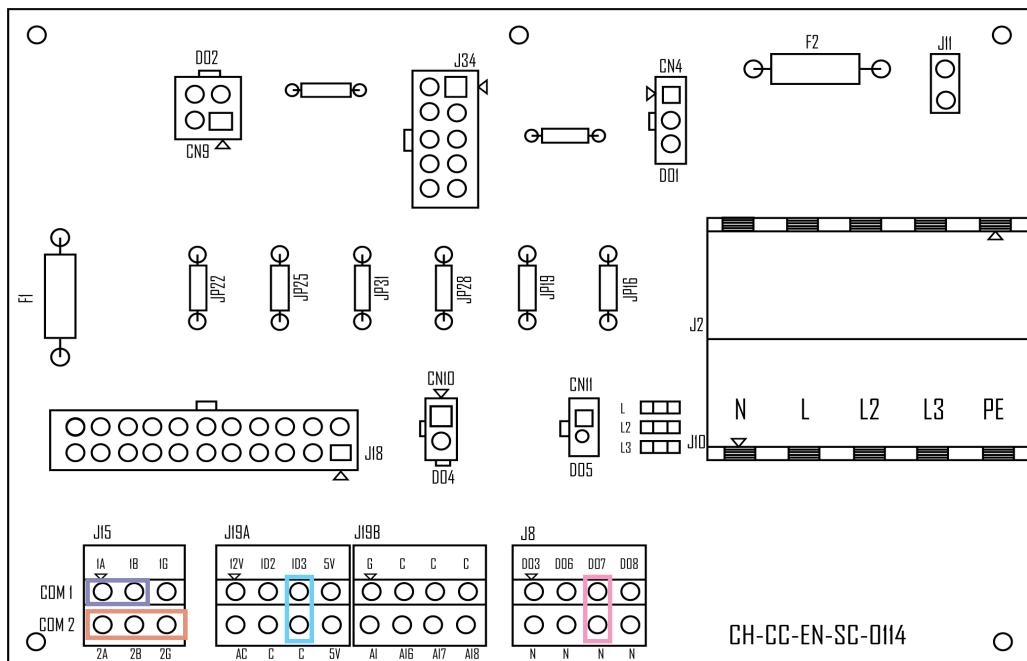

Connector	Terminals	Connection	Type
J10	PE	Connect the earth cable	3-Ph/N/PE power supply, 400 Vac, 50Hz.
	N	Connect the neutral cable from the main power supply	
	L	Connect the L1 phase cable from the main power supply	
	L2	Connect the L2 phase cable from the main power supply	
	L3	Connect the L3 phase cable from the main power supply	
J15	1 A	User Interface signal terminal 7	
	1B	User Interface signal terminal 8	
	1G	User Interface signal terminal 9	
J19A	12 Vac	User interface power supply terminal 12	power supply, use a 2x1mm <sup>2</sup> cable supplied with the HMI, maximum length 3m
	AC	User interface power supply terminal 13	
J15	2 A	Navistem T3100 OCI 351 (A+) connection	use a 3x0.5mm <sup>2</sup> shielded stranded cable. MAX length: 1000 m Bus terminator: 120 Ohm and 1 nF
	2B	Navistem T3100 OCI 351 (B-) connection	
	2C	Navistem T3100 OCI 351 (GND) connection	
J19A	ID2	Programmable input (caution, not configured in the factory, for silent ventilation function set H46= 25)	Dry contact Closed = silent mode activated, Open = silent Mode deactivated
	ID3	Remote on/off input	Dry contact closed=HP on / open=HP off
J19B	AI6	No function	Analogue input
	AI7	No function	
	AI8	No function	
J8	DO3 (*)	No function	Single phase voltage output 230 Vac, 50 Hz, max. current 300 mA (AC1)
	DO6 (*)	Defrosting signal output (CAUTION: not configured in the factory, set H84=21)	Single phase voltage output 230 Vac, 50 Hz, max. current 300 mA (AC1)
	DO7 (*)	Default programmable output of HP (CAUTION: not configured in the factory, set H85=47)	Single phase voltage output 230 Vac, 50 Hz, max. current 300 mA (AC1)

(\*) in case of use, it is advisable to control the coil of a relay or contactor with the output voltage to manage the resource

## 4. Pre-requisites before commissioning

### 4.1. Verification before switching on

- Check that there are no leaks. Each operator must be equipped with a personal explosimeter for R290 gas and a leak detector.
- Check that the electrical and hydraulic diagrams of the installation the machine is connected to are available.
- Check that there are safety valves, filters and the expansion system.
- Ensure that the isolation valves of the hydraulic circuits are open.
- Ensure that the hydraulic circuit is filled, pressurised and bled.
- Check that all of the hydraulic connectors are fitted correctly and that all of the instructions on the labels have been followed.
- Ensure that arrangements have been made to evacuate the condensation.
- Check that the terminals are connected and attached correctly. Check the order of the phases, the voltages between each phase and the neutral, then between each phase and the earth.
- Check if the electrical connections comply with the regulations in force, including the earth.
- The voltage must be the same as that stated on the appliance's rating plate.
- Ensure that the voltage is definitive and within the tolerance limits ( $\pm 5\%$ ).
- Check if the electrical resistors of the compressor housings are powered correctly.
- Check, if prescribed for the location of installation, whether a differential circuit breaker is installed.
- Check for electrical personal protective equipment (differential circuit breaker, differential switch, etc.).
- Before switching on, check if all of the cover panels have been fitted and attached with the appropriate screws.

**CAUTION:**

- **Power up the unit (see § 4.2) for at least 12 hours before switching it on, in order to enable the resistors to heat the compressor crankcase enough (the resistors are automatically supplied when the switch is closed) and that the compressor discharge sensor is cold, approximately 20°C. The heating elements are operating correctly if after a few minutes the temperature of the compressor crankcase resistor is 10 to 15°C hotter than the ambient temperature.**
- **Check that the weight of the pipes is not resting on the machine structure.**
- **Stop the appliance temporarily, do not switch off the power supply using the main isolator switch; this operation must only be used to switch off the electrical power supply to the appliance for prolonged stoppages (for example, seasonal holidays, etc.). Furthermore, the absence of voltage means that the crankcase resistors are no longer powered and that there is a risk of compressor failure when the unit is switched back on.**
- **Do not modify the electrical connections of the appliance, otherwise this will nullify the warranty immediately.**

## 4.2. Switching On



### IMPORTANT:

Switching on with an incorrect power supply will result in the immediate destruction of some electronic components.

When powering up, check that the 3 LEDs (L, L2, L3) to the left of the terminal block light up.

Check that the voltage is correct on the terminal block using a multimeter (400 V +/- 10% between phases and approximately 230 V between neutral and phases)

## 4.3. HP/Navistem pairing

It is essential to follow the start-up procedure associated with the User Interface (UI):

- Power the HP with the UI alone, without the Navistem T3100 (turn off the Navistem T3100).



### CAUTION:

Ensure that parameters H124 = 1 and H142 = 1

For parameter H124

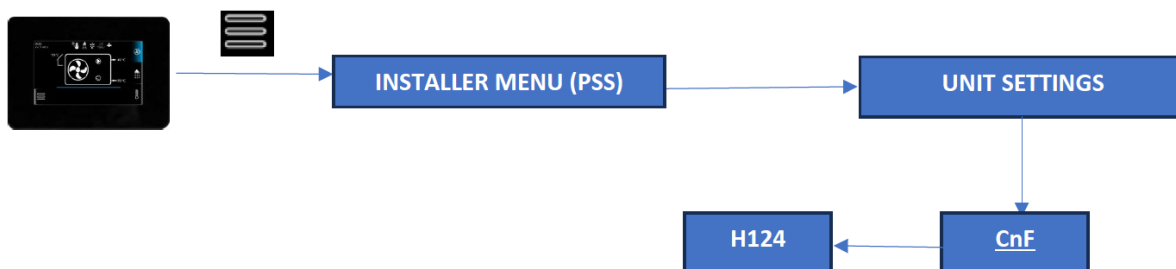

For parameter H142

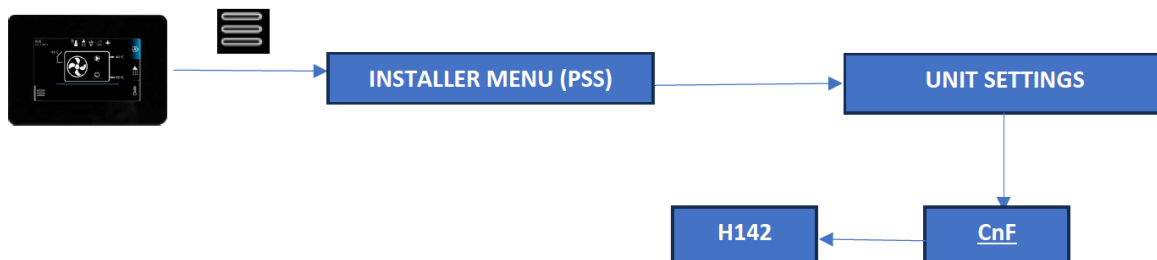

- Switch off the power supply to the HP.
- Switch on the NAVISTEM T3100.
- Check that the cap on the air vent of the degasser always remains open.
- Switch on the HP.



### CAUTION:

Failure to comply with a single action will result in the Navistem T3100 being unable to control the HP.

## 4.4. HP hydraulic flow adjustment

You are responsible for carrying out the hydraulic flow adjustment service on the ECOMOD. Please refer to the Navistem T3100 manual adapted to your application (heating/HydraMax/Hybrid) and the sizing study so that you are familiar with the layout of the components to be adjusted as well as the target flow rate value. See chapter 9, HYDRAULIC DIAGRAMS AND CONFIGURATIONS.

The hydraulic flow is adjusted by starting the circulation pump in forced running mode at maximum speed.

To activate this function:

- ECOMOD screen in OFF mode

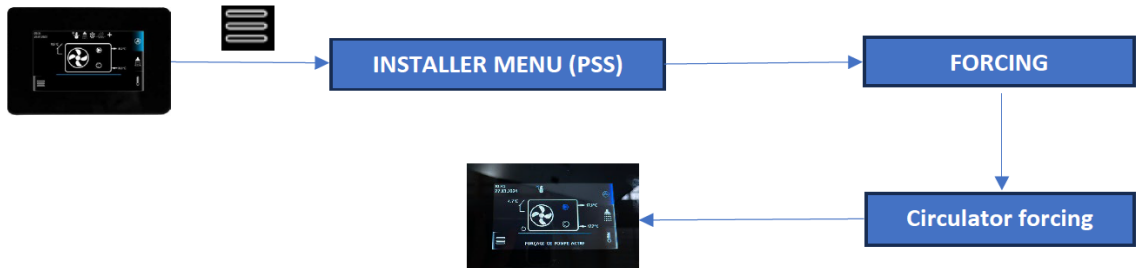

To deactivate this mode:

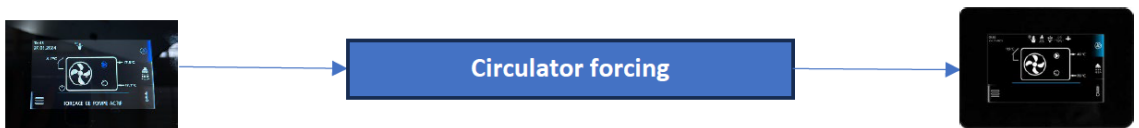

To exit the forced running mode of the pump, press the same buttons again for 3s. Circulation pump shutdown is effective 2min. after exiting the mode.

Note: This manual mode is also deactivated under the 3 conditions below:

- by switching to another mode,
- with a HP fault (for example: flow controller with irrigation fault),
- after 1 hour of manual operation.

### 4.5. Operating diagram

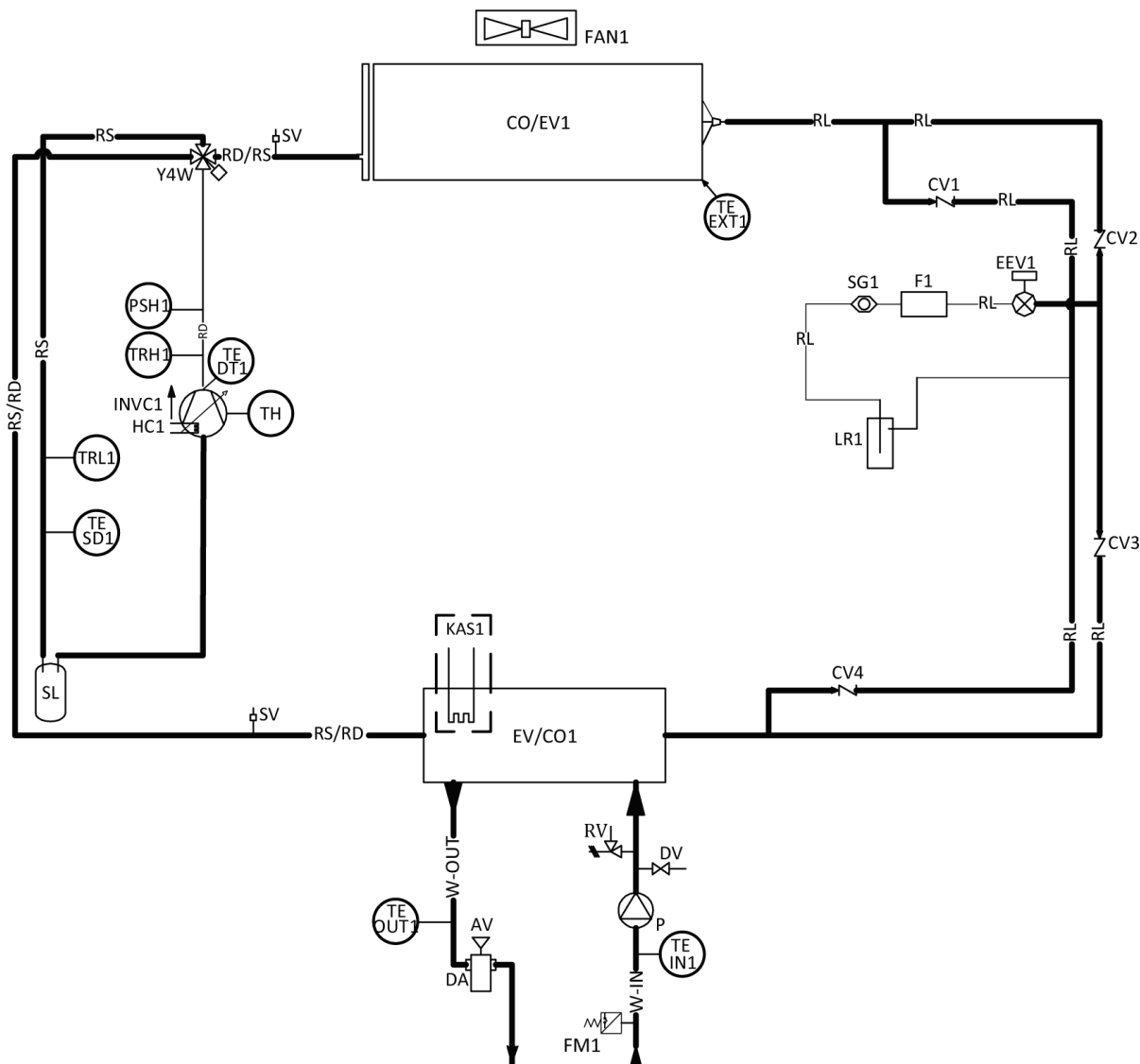
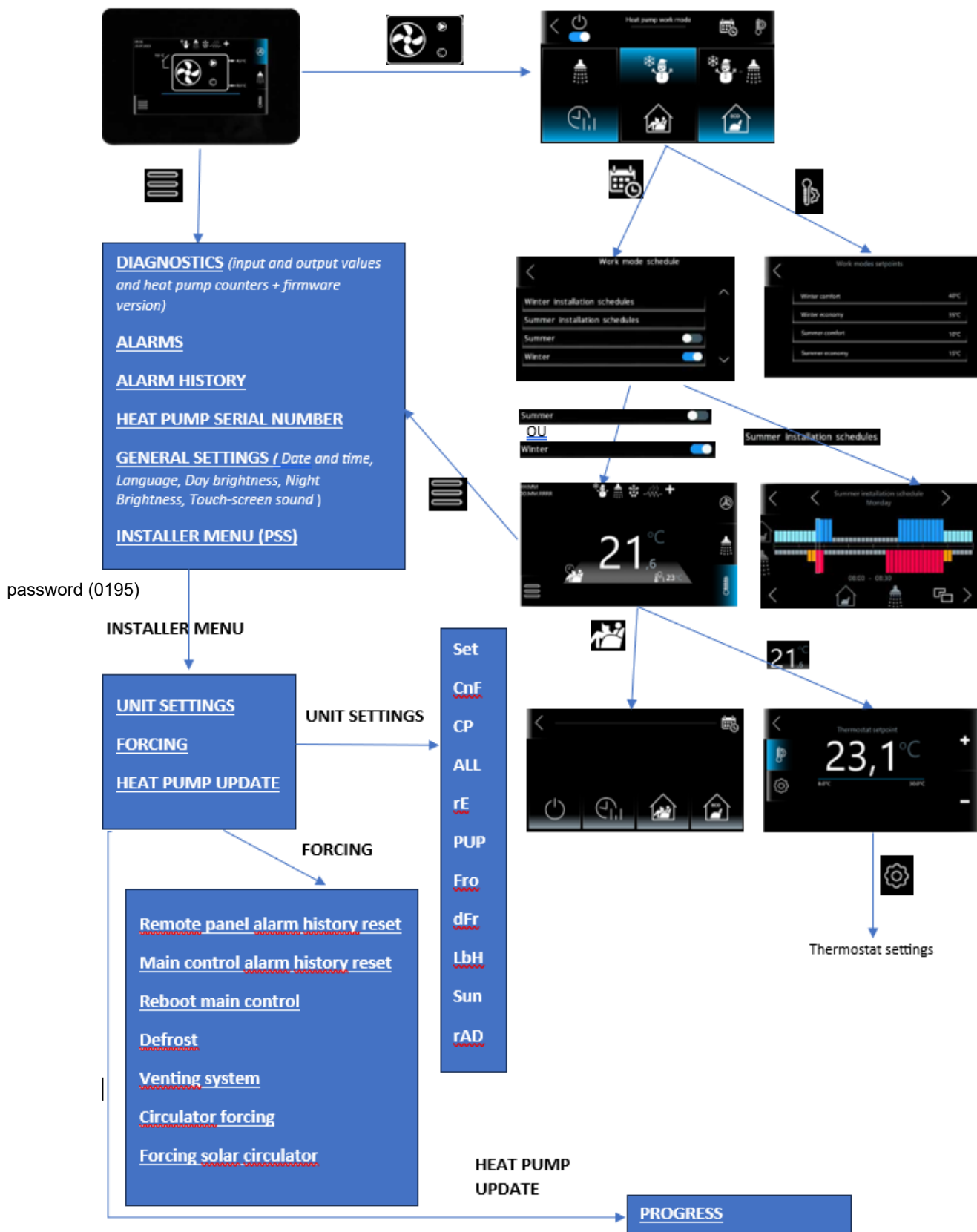

figure 11 - Operating diagram

LEGEND			
SIGN	DESCRIPTION	SIGN	DESCRIPTION
INVC	Variable speed compressor	W-OUT	Factory water outlet line
CO	Battery	W-IN	Factory water inlet line
EV	Plate exchanger	TRH	High pressure transducer
EEV	Electronic expansion valve	TRL	Low pressure transducer
YISV	4 way cycle reversing valve	TE EXT	External air temperature sensor
KAS	Exchanger frost-free resistor	TE SD	Suction line temperature sensor
F	Filter	TE DT	Compressor evacuation temperature sensor
SV	Charging connector	PSH	HP (high pressure) pressure switch
HC	Housing resistor	TE IN	Return temperature sensor
FAN	Axial fan	TE OUT	Start temperature sensor
RS	Suction line	DV	Draining valve
RD	Discharge line	RV	Safety valve
RL	Fluid line	FM	Flow meter
RD/RS	Suction/discharge line	P	Pump
RS/RD	Suction/discharge line	AV	Automatic vent valve
LR	Liquid collection	DA	Degasser
TH	Compressor thermostat		



## 4.6. Navigating the User Interface







## 5. CONTROL INTERFACE

### 5.1. Recommendations and warnings

	The removal and/or handling of any safety device is strictly prohibited.
	This appliance should only be used by authorised persons.
	Working on the appliance when it is in operation is prohibited.
	The modification of the programming of the appliance by an unauthorized person is prohibited.
	Unaccompanied children and persons with disabilities are not allowed to use the appliance.
	Touching the appliance with bare feet or with wet or damp body parts is prohibited.
	Cleaning is prohibited when the appliance is powered on.
	Pulling, disconnecting or twisting the electrical cables coming out of the appliance, even if the appliance is disconnected from the power supply, is prohibited.
	Do not stand on the appliance, sit on it and/or place objects of any kind on it.
	Do not splash the appliance or spray water onto it.
	Do not disperse, put down or leave within the reach of children the packing material (cardboard, staples, plastic bags, etc.) as it can be a potential source of danger.
	All of the operations described below must be carried out BY QUALIFIED PERSONNEL ONLY.
	The electrical wiring of the terminal blocks must be carried out by qualified personnel only.
	All routine or extraordinary maintenance must be performed with the unit at a standstill without power supply.
	Do not put your hands or insert screwdrivers, wrenches or other tools into the moving parts.
	The machine operator and the maintenance personnel must receive the appropriate training in order to perform their tasks in complete safety.
	Only authorised personnel are allowed to access the electrical panel.
	Operators must know how to use personal protective equipment and be familiar with the accident prevention rules prescribed by national and international laws and regulations.
	The operator's work area must be kept clean, in order, and free of any objects that may obstruct free passage. Adequate lighting of the work area must be provided so as to enable the operator to carry out the required operations in complete safety. Low or excessive lighting can generate risk.
	Ensure that work areas are always sufficiently ventilated and that extraction systems are operating properly and in accordance with the requirements of applicable laws.
The configurations described cannot all be activated and/or modified at the same time.	
The company excludes all contractual and extra-contractual liability for damage to persons, animals and property caused by an installation, incorrect adjustment and/or maintenance, misuse of the equipment or partial or superficial reading of the information contained in this manual.	

	<p>Install a suitable protective device and power switch upstream of each unit, with a delayed characteristic curve, a contact opening of at least 3 mm and adequate breaking capacity and residual current protection. The size of the circuit breaker must comply with the absorption of the unit. See the TECHNICAL DATA in the user/installer manual that accompanies the unit. Also take back-up heaters into account.</p>
	<p>Before carrying out any work on the electrical panel, IT IS MANDATORY to:</p>
	<ul style="list-style-type: none"> <li>- Turn off the appliance from the control panel ("OFF" is displayed).</li> </ul>
	<ul style="list-style-type: none"> <li>- Set the protection device to "OFF".</li> </ul>
	<ul style="list-style-type: none"> <li>- Wait 15 seconds before accessing the electrical panel.</li> </ul>
	<ul style="list-style-type: none"> <li>- Check the earthing before performing any operation.</li> </ul>
	<ul style="list-style-type: none"> <li>- Stay well insulated from the ground, with dry hands and feet, or using insulated platforms and gloves.</li> <li>- Keep foreign objects away from the system.</li> </ul>

	<p>The power supply must comply with the limits indicated on the data label of the appliance: otherwise, the warranty expires immediately. Before starting any type of operation, make sure that the power is turned off.</p>
	<p>Connect the conductors in the following order: phase, neutral and earth.</p>
	<p>The sizing of the power cables must take into account the TECHNICAL DATA provided in the manual that accompanies the unit. Also take back-up heaters into account.</p>
	<p>Effective earthing is mandatory; the manufacturer is not responsible for damage caused in its absence.</p>
	<p>During maintenance, the unit must be disconnected from the power supply and must be disconnected in such a way that the operator can verify, regardless of the place being accessed, that the plug remains disconnected.</p>
	<p>Use cables that meet the applicable regulations of the different countries.</p>
	<p>After 10 minutes of operation of the appliance, make sure that the screws on the power terminal block remain tight.</p>

## 5.2. Interface utilisateur



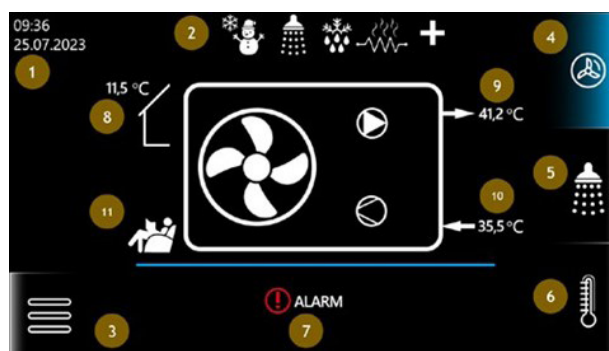







L'IHM dispose de 6 touches capacitives.

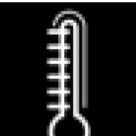
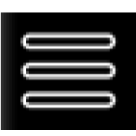





Number	Description
1	Date and time
2	The message 'NO COMMUNICATION' is displayed if there is no communication between main control and e-Lite remote control (in this case, check that the connection is correct)
3	Main menu
4	Heat pump screen
5	DHW screen
6	Thermostat screen
7	Active alarms and forcing
8	Outside temperature
9	Water flow temperature
10	Water inlet temperature
11	Current heat pump status



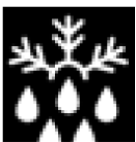

### 5.3. HMI description



The following list represents the present icons, and their meaning

Icon	Description	Note
	Heat pump screen	Heat pump in heating system.
	DHW screen	Opens the domestic hot water screen.
	Thermostat screen	Opens the thermostat screen.
	Menu	Opens the menu screen.
	Cooling	Heat pump in system cooling.
	Heating	Heat pump in heating system.
	Domestic hot water	Heat pump in heating system.
	Set-point Comfort	Comfort set-point enabled.
	Set-point Economy	Set-point economy enabled.
	Compressor	White symbol, steady: compressor Off. White symbol, flashing: compressor on call. Blue symbol, fixed: compressor On.
	Circulator	White symbol: circulator Off. Blue symbol: circulator On

	Alarm	List of active alarms.
	ON/OFF	Switches the heat pump on or off.
	Chronothermostat	Enables or disables the chronothermostat.
	Defrosting	Steady symbol, if the heat pump is in defrost mode. Flashing symbol, if the heat pump is in defrost call.
	Antifreeze resistance	The antifreeze resistor is in operation.
	Anti-legionella	Fixed symbol if the heat pump is running the anti-legionella cycle. Flashing symbol if the anti-legionella cycle has not been completed.

The possible states of the heat pump are as follows

Icon	Description
	Manually enabled comfort set-point.
	Manually enabled economy set-point.
	Heat pump in manual stand-by.
	Chronothermostat enabled, with comfort set-point active.
	Chronothermostat enabled, with economy set-point active.

	<p>Chronothermostat enabled, heat pump in stand-by mode.</p>
	<p>Set-point comfort enabled by forcing “digital input” (see heat pump MCO, “secondary set-point from digital input”).</p>
	<p>Set-point economy enabled by forcing “digital input” (see heat pump MCO, “Secondary set-point from digital input”).</p>

If you tap on the symbol  , the operating modes of the heat pump are displayed :



If you tap on the symbol  the setpoint setting tab is displayed :

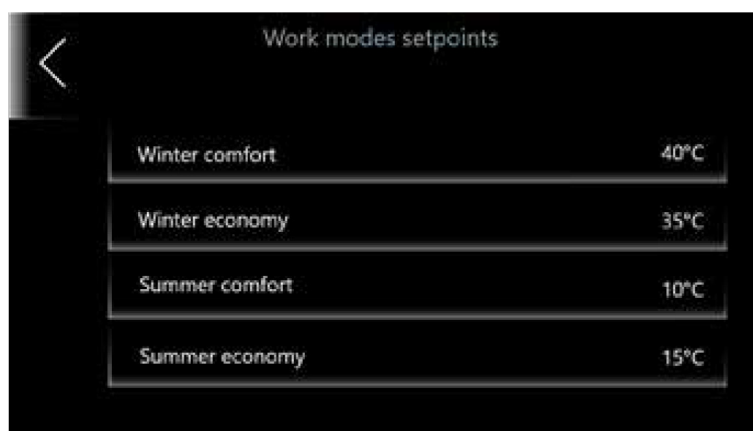

If you tap on the symbol , the mode selection and timing screen is displayed :

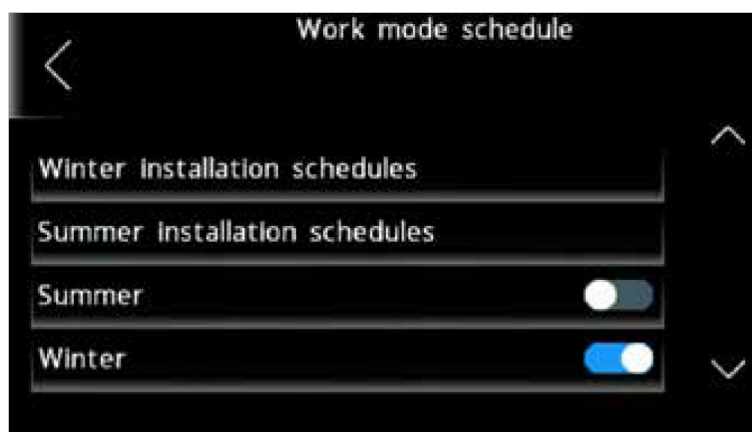

If you tap on the season selection switch, the selected season is active for the heat pump and thermostat function.

If you tap the summer programming chrono switch, the chrono programming screen is displayed:

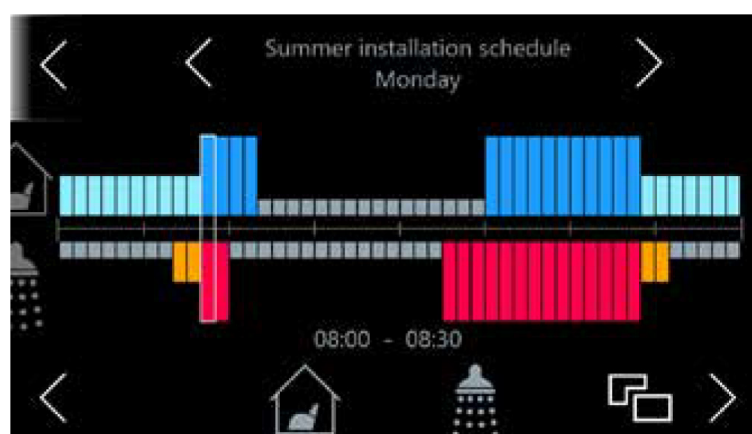

The strip represents the day, which is divided into 48 parts. The duration of each part is 30 minutes. You can change the day with the > and < arrows.

The low blue strip represents the enablement of the cooling mode, with Economy setpoint.

The high blue strip represents the enablement of the cooling mode, with Comfort setpoint.

The low orange strip represents the enabling of the heating mode, with Economy setpoint.

The high red stripe represents the enabling of the heating mode, with Comfort setpoint.

The grey stripe represents disabled mode.

It is possible to scroll left or right, modifying each slightest division, by enabling the following symbols :

Icon	Description
	<p>Heat pump (water outlet configuration) OFF. By scrolling left and right with the arrows, the water outlet configuration of the heat pump system is disabled.</p>
	<p>Heat pump (water outlet configuration). By scrolling left and right with the arrows, the water outlet configuration of the system is enabled, in cooling mode with the Comfort set-point.</p>
	<p>Heat pump (water outlet configuration). Scrolling left and right with the arrows enables the configuration of the system water outlet in cooling mode with the Economy set-point.</p>
	<p>Heat pump (water outlet configuration). Scrolling left and right with the arrows enables the configuration of the system water outlet in heating mode with the Comfort set-point.</p>
	<p>Heat pump (water outlet configuration). Scrolling left and right with the arrows, enables the configuration of the system water outlet in heating mode with the Economy set-point.</p>
	<p>Heat pump, DHW OFF. Scrolling left and right with the arrows, the DHW configuration of the heat pump is set to OFF.</p>
	<p>Heat pump, DHW configuration. Scrolling left and right with the arrows enables the configuration of the system water outlet in cooling mode with the Comfort set-point.</p>
	<p>Heat pump (water outlet configuration). Scrolling left and right with the arrows enables the configuration of the system water outlet in cooling mode with the Economy set-point.</p>



## 5.4. Thermostat display



Thermostat function, which uses the e-LITE, internal probe to measure the room temperature. By activating this function, the internal probe will be used to switch the heat pump on or off.

The thermostat call will be sent to the heat pump if:

- The unit is in cooling or heating mode
- The internal temperature probe has not reached the set-point

NOTE:

In the centre of the screen, the temperature measured by the internal probe is displayed. At the bottom right, the current setpoint value is displayed.

### 5.4.1. Setting the room thermostat setpoint

Tapping on the measured temperature displays the setpoint change screen:







Tapping on the gear symbol, the thermostat settings are displayed:

Function	Description	Range
Winter comfort	Comfort setpoint for heating operation mode	20°C / 78°C
Winter economy	Economy setpoint for heating operation mode	20°C / 78°C
Summer comfort	Comfort setpoint for cooling operation mode	5°C / 20°C
Summer economy	Economy setpoint for cooling operation mode	5°C / 20°C
Thermostat hysteresis	After the room setpoint has been reached, the room call will be sent to the heat pump again, when the room temperature: in heating mode: falls lower than 'room setpoint - thermostat hysteresis'. In cooling mode: increases over 'air setpoint + thermostat hysteresis'.	0°C / 5°C
Correction of displayed temperature	Correction of temperature detected by internal probe	-5°C / +5°C

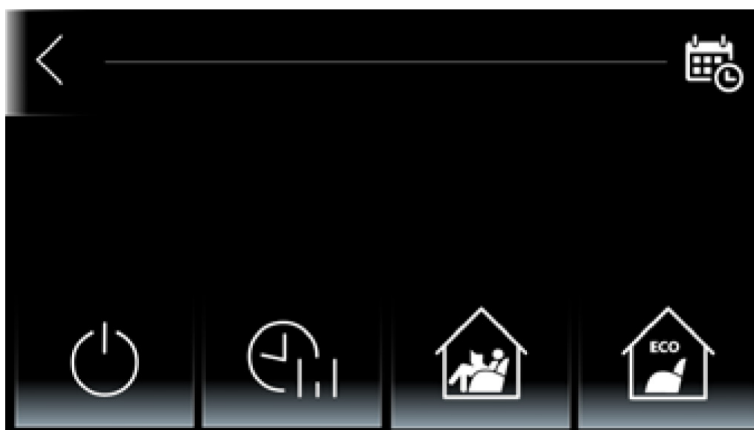
### 5.4.2. Operating mode of the thermostat

On the thermostat's main screen, tapping on the status symbol in the bottom left-hand corner displays the thermostat's operating modes:



Icon	Description	Note
	ON/OFF	Activates/deactivates the thermostat function
	Chrono programming	Enables or disables chrono programming
	Comfort Setpoint	<ul style="list-style-type: none"> <li>Switches to thermostat comfort setpoint, manual mode</li> <li>Displayed if the chronothermostat is active and in comfort mode.</li> </ul>
	Economy Setpoint	<ul style="list-style-type: none"> <li>Switches to thermostat economy setpoint, manual mode</li> <li>Displayed if the chronothermostat is active and in economy mode</li> </ul>

Tapping on the symbol  , the operating season and the thermostat timer are displayed:

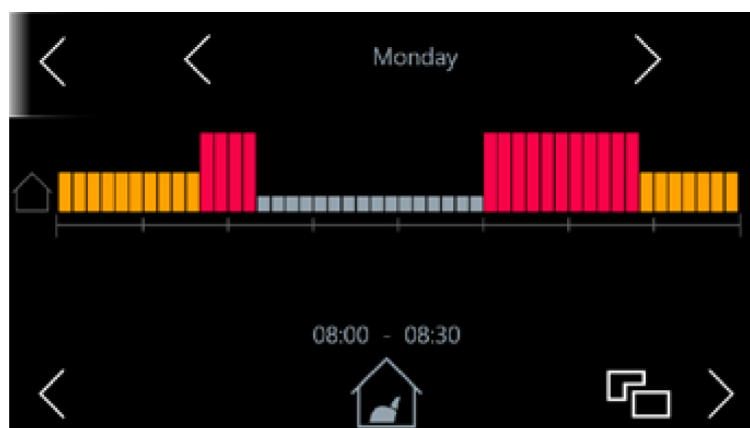





The strip represents the day, which is divided into 48 parts. The duration of each part is 30 minutes. It is possible to change the day with the > and < arrows.

The low blue stripe represents cooling operation, Economy setpoint. The low blue stripe represents cooling operation, setpoint Comfort. The low orange stripe represents heating operation, Economy setpoint. The low red stripe represents heating operation, setpoint Comfort.

Grey stripe, represents disabled mode.

The «copy symbol» , allows to select the days of the week, where we want to have the same program as the day shown. Scrolling to the left and right, you can edit each smallest division, enabling the following symbols:

Icon	Description
	Heat pump (water outlet configuration) OFF. Scrolling left and right with the arrows, the water outlet configuration of the heat pump system is disabled.
	Heat pump (water outlet configuration). Scrolling left and right with the arrows, the water outlet configuration of the system is enabled, in cooling mode with the Comfort set-point.
	Heat pump (water outlet configuration). Scrolling left and right with the arrows enables the water outlet configuration of the system, in cooling mode with the Economy set-point.
	Heat pump (water outlet configuration). Scrolling left and right with the arrows enables the configuration of the system water outlet in heating mode with the Comfort set-point.
	Heat pump (water outlet configuration). Scrolling left and right with the arrows enables the configuration of the system water outlet in heating mode with the Economy set-point.

## 5.5. Menu

From the main screen, tapping on the menu symbol (bottom left) displays the main menu:

### 5.5.1. Diagnostics

In this area, input and output values and heat pump counters are displayed. NOTE: The firmware version of the main control board and the e-Lite can also be found here.

### 5.5.2. Alarms

List of active alarms.

Tapping on the reset symbol , will reset all alarms that are no longer active.

### 5.5.3. Alarm History

Alarm history, with date and time of alarm occurrence and stop.

### 5.5.4. Heat Pump Serial Number

Heat pump serial number.

### 5.5.5. Generals settings

- Date and time
- Language
- Day brightness: Brightness Day: percentage of display brightness while using the e-LITE.
- Night Brightness: percentage of display brightness when the e-LITE is in stand-by mode.
- Touch-screen sound: enable or disable tap sound.

### 5.5.6. Installer Menu

This menu provides access to heat pump configurations and functions. This menu provides access to heat pump configurations and functions. User password: 0000. Depending on the password level entered, different menus are displayed.

#### 5.5.6.1. Unit settings

The parameters displayed depend on the password set:

This menu gives access to all machine parameters.

The parameters are collected in groups, each group is identified by a three-digit code, while the index of each parameter is preceded by a letter.

Description	Group identification code	Parameter index	Visibility
Local water set-points (in cooling and heating, eco and normal). When the e-LITE remote control is connected to the heat pump, reference is not made to these set-points, but to those on page.	Set	User	---
Configuration	CnF	H01-	Installer
Compressor	CP	C01-	Installer
Alarms	ALL	A01-	Installer
Adjustment	rE	b01-	Installer
Pump	PUP	P01-	Installer
Electrical heaters	Fro	r01-	Installer
Defrosting	dFr	d01-	Installer
Hz min / max	LbH	L0-	Installer
*Solar	SUn	S01-	Installer
*Mixing valve	rAD	i01-	Installer

The PSS menu is accessed to enter the maintainer password and to enable higher privilege access. Once entered, the duration of the password is one hour, or until the control is switched off.

#### 5.5.6.2. Forcing

**This menu is protected by an installer password.**

- Remote panel alarm history reset: resets the e-LITE alarm history
- Main control alarm history reset: resets the main control alarm history
- Reboot main control: restarts the main control of the heat pump (only enabled if the heat pump is in stand-by)
- Defrost: forces a manual defrost (see conditions to enable defrost, in heat pump MCO)

- Venting system: activation of the circulator to force venting of the system. With a tap, the function is activated. With the function active, a new tap on it disables it. Note that the command is only accepted if the heat pump is in the OFF state. The heat pump suspends this function if the operating mode changes from OFF to another mode, even if the function time has not expired.
- Circulator forcing: This function is used to manually force the circulation circulator to run at 100% for 1 hour. A tap on this function will activate it. With the function active, a new tap on it disables it. Note that this command is only accepted if the heat pump is in the OFF state. The heat pump will suspend this function if the operating mode is changed from OFF to another mode, even if the function time has not expired.
- Forcing solar circulator: This function is used to manually enable the solar circulator. A tap on this function will enable it. With the function active, a new tap on it disables it. Note that this command is only accepted if the heat pump is in the OFF state. The heat pump will suspend this function if the operating mode is changed from OFF to another mode, even if the function time has not expired.

NOTE:

The main screen will be displayed when a forcing is activated.

### **5.5.6.3. Heat pump update**

---

This menu is protected by an installer password.

- FW UPDATE: Main control board firmware update
- PARAMETERS UPDATE: Main control board parameter update
- PARAMETERS EXPORT: exports parameters and alarm history of main control.
- PROGRESS: progress status.

## 6. TROUBLESHOOTING

### 6.1. Problem-solving without error code

Problems encountered	Cause	Solution
The appliance does not start up	Electrical power supply absent	Check the system voltage Check the protective systems upstream of the unit
	Electronic board damaged Compressor faulty	Replace the damaged part
Insufficient performance of the unit	Insufficient quantity of refrigerant and unsuitable hydraulic flow or aeraulics System incorrectly sized	Check the installation of the unit, any clogging of the hydraulic filters and the cleanliness of the fins
Noise from the compressor	Improper attachment Incorrect installation	Check
The compressor does not start up due to protective devices	Discharge pressure too high Suction pressure too low Supply voltage incorrect Wiring incorrect Poor working conditions Thermal protection triggered	Check
	Pressure switch damaged	Replace
Discharge pressure from the compressor is high	Outside air temperature is high System return water temperature is high Air in the hydraulic system	Check
	Insufficient air flow rate Low water flow rate	Check the fan and the pump are operating correctly
Discharge pressure from the compressor is low	Outside air temperature is low System return water temperature is low Residual moisture in the cooling circuit Air present in the hydraulic circuit Insufficient refrigerant gas charge	Check
Compressor suction pressure is high	Outside air temperature is high System return water temperature is high Expansion valve too open/damaged	Check
Compressor suction pressure is low	Outside air temperature is low System return water temperature is low Expansion valve too closed/clogged/damaged Plate heat exchanger dirty	Check
	Insufficient air flow rate Insufficient water flow rate	Check the fan and the pump are operating correctly

## 6.2. Error codes and diagnostic assistance

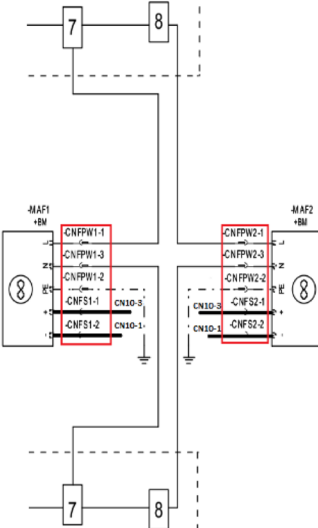
Code	Descriptif	Cause	What to check	What to do						
E000	External stop required	Open dry contact ID3	customer control wired to ID3 input	Position according to wired customer order						
E001	High-pressure alarm	The pressure transducer detects a pressure that exceeds the 'high-pressure set' (30.3 bar). It returns when the pressure drops below 22.8 bar.  If the alarm occurs more than 3 times per hour, the reset becomes manual.	<ul style="list-style-type: none"> <li>• Check that the reading is correct with a pressure gauge placed on the high-pressure charge port. See § 3.6.7.</li> <li>• If the alarm occurs in heating mode, check the function and fastening of the thermostatic valve EEV.</li> </ul>	<ul style="list-style-type: none"> <li>• Replace the EEV coil if an alarm occurs -Replace the EEV valve body.</li> <li>• Check that the S014 water flow corresponds to the minimum flow required. Check filter condition and circulator operation. And if flow rate is good, check delta T (scaling).</li> </ul>						
E002	Low-pressure alarm	The pressure transducer detects a pressure lower than the 'low-pressure set'. Set low pressure in heating = 0.3bar Returns when pressure rises above 4bar in cooling and 2.3bar in heating. If the alarm occurs more than 3 times per hour, the reset becomes manual	<ul style="list-style-type: none"> <li>• Check for gas leaks in the refrigeration circuit (leakage detector, ...)</li> <li>• Check that the low-pressure transducer reading is correct by placing a pressure gauge on the low-pressure charge port. See § 3.6.7</li> <li>• Check the fixing and operation of the EEV thermostatic valve, physically verifying that the change of steps of the valve displayed on the SCADA corresponds to the actual valve movement</li> </ul> 	<ul style="list-style-type: none"> <li>• If leaks are detected, recover the remaining refrigerant, repair the leak if possible and restore the charge by checking the data on the technical label</li> <li>• If the pressure gauge reading does not match the reading given by the low-pressure transducer, replace the low-pressure transducer</li> <li>• If the EEV valve malfunction occurs, replace the coil. If the error persists, replace the valve body.</li> <li>• Ensure that the valve tube is not plugged by positioning the magnet on the valve by checking the effect it has on error E002. If the error persists the pipe is plugged. If the error disappears, replace the EEV coil</li> <li>• Check fan operation. If it does not work, check the CNFPW connectors on the panel relating to the fan(s):</li> </ul> <table border="1" data-bbox="1129 1451 1473 1585"> <thead> <tr> <th>power connector</th> <th>signal connector</th> </tr> </thead> <tbody> <tr> <td>12 (FAN 1)</td> <td>13 (FAN 1)</td> </tr> <tr> <td>13 (FAN 2)</td> <td>15 (FAN 2)</td> </tr> </tbody> </table>	power connector	signal connector	12 (FAN 1)	13 (FAN 1)	13 (FAN 2)	15 (FAN 2)
power connector	signal connector									
12 (FAN 1)	13 (FAN 1)									
13 (FAN 2)	15 (FAN 2)									
E005	Antifreeze alarm	If the flow water probe (ST2) has a value below A08 (default 3°C), This alarm is manually reset. it is active after 2 min. The alarm resets when the temperature returns to a value above 6°C.	<ul style="list-style-type: none"> <li>• The temperature probe is correctly inserted in the outlet water well</li> <li>• Check the temperature at the discharge probe with a reference thermometer.</li> </ul>	<ul style="list-style-type: none"> <li>• If the probe is not correctly inserted in the thermowell, insert it.</li> <li>• If the temperature measured by the reference thermometer differs from the temperature measured by the temperature sensor, the sensor is defective; replace it.</li> </ul>						

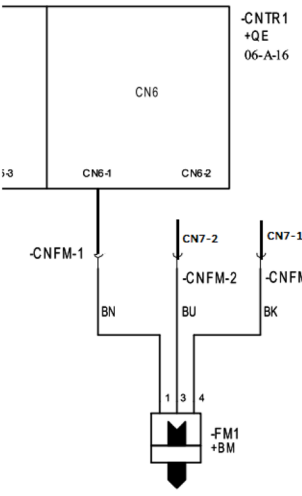
Code	Descriptif	Cause	What to check	What to do												
E005	Antifreeze alarm	If the flow water probe (ST2) has a value below A08 (default 3°C), This alarm is manually reset. It is active after 2 min. The alarm resets when the temperature returns to a value above 6°C.	<ul style="list-style-type: none"> <li>The temperature probe is correctly inserted in the outlet water well</li> <li>Check the temperature at the discharge probe with a reference thermometer.</li> </ul>	<ul style="list-style-type: none"> <li>If the probe is not correctly inserted in the thermowell, insert it.</li> <li>If the temperature measured by the reference thermometer differs from the temperature measured by the flow sensor, the sensor is defective; replace it.</li> </ul>												
E006	Flow alarm	If the flowmeter diagnoses a lack of flow for a consecutive time of 5 seconds. If the alarm occurs more than 3 times per hour, the reset becomes manual. In the event of a flow error, the pump goes into the post-irrigation phase (duration of P02 default 2 minutes). If, during this phase, the flow returns for a time of 5 seconds, then the alarm automatically returns, but only if the number of alarm interventions per hour is no more than 3.	<ul style="list-style-type: none"> <li>Check the system pressure.</li> <li>Checking the functioning of the flowmeter by checking the wiring of connector 5 (CNFM)</li> </ul>  <ul style="list-style-type: none"> <li>Check the correct installation of water inlet and outlet pipes on the machine.</li> <li>Check the condition of system water filters.</li> <li>Check valves...hoses, balancing valves.</li> </ul> <table border="1" data-bbox="1125 1232 1476 1489"> <tr> <td>en m³/h</td> <td>23kW</td> <td>27kW</td> </tr> <tr> <td>Minimum flow rate</td> <td>1.62</td> <td>1.90</td> </tr> <tr> <td>Maximum flow rate</td> <td>5.43</td> <td>6.37</td> </tr> <tr> <td>Threshold flow rate for cut-off</td> <td>0.90</td> <td>1.10</td> </tr> </table>	en m³/h	23kW	27kW	Minimum flow rate	1.62	1.90	Maximum flow rate	5.43	6.37	Threshold flow rate for cut-off	0.90	1.10	<ul style="list-style-type: none"> <li>Check that deaerators and air vents are open. Check that there is no high point in the system without an air vent.</li> <li>If air is present in the hydraulic system, vent it by performing the function. With the machine in OFF, once the installer password has been entered, enter the forcing menu (FOR) and then choose PumP. The system bleeding function is activated, which consists of activating the utilisation pump for 5 minutes. During this phase, the pump alternates between maximum and minimum speed cycles lasting 1 minute. Pressing PumP again allows the procedure to be aborted. The pump will still eventually perform a post-pumping of P02 (default 2 minutes).</li> <li>If the problem persists, replace the flowmeter.</li> </ul>
en m³/h	23kW	27kW														
Minimum flow rate	1.62	1.90														
Maximum flow rate	5.43	6.37														
Threshold flow rate for cut-off	0.90	1.10														
E008	Compressor driver limitation alarm	If the compressors do not exceed the minimum frequency during the lubrication phase, the compressor is stopped, and alarm E008 is displayed. If the compressor does not reach speed at the expected ramp value within 30 minutes, the alarm becomes active, and the compressor is switched off for safety. If the number of interventions in one hour of the alarm is 3, it becomes manually reset.	<ul style="list-style-type: none"> <li>Measure the impedance between the compressor phases with the tester : <table border="1" data-bbox="766 1601 1109 1758"> <tr> <td></td> <td>Coil resistance at 20°C</td> </tr> <tr> <td>23kW</td> <td>0.299 Ω</td> </tr> <tr> <td>27kW</td> <td>0.177 Ω</td> </tr> </table> </li> <li>Check correct fan operation by checking the CNFPW connector.</li> <li>Check the continuity of the connection between U, V and W of the inverter and U, V, and W of the compressor.</li> </ul>		Coil resistance at 20°C	23kW	0.299 Ω	27kW	0.177 Ω	<ul style="list-style-type: none"> <li>If the measured impedance values deviate from the values in the table, replace the compressor</li> </ul>						
	Coil resistance at 20°C															
23kW	0.299 Ω															
27kW	0.177 Ω															

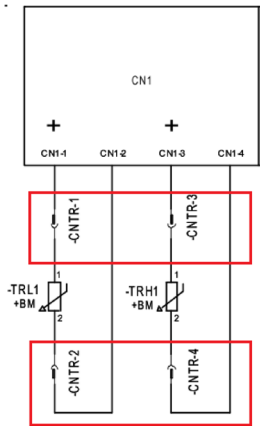
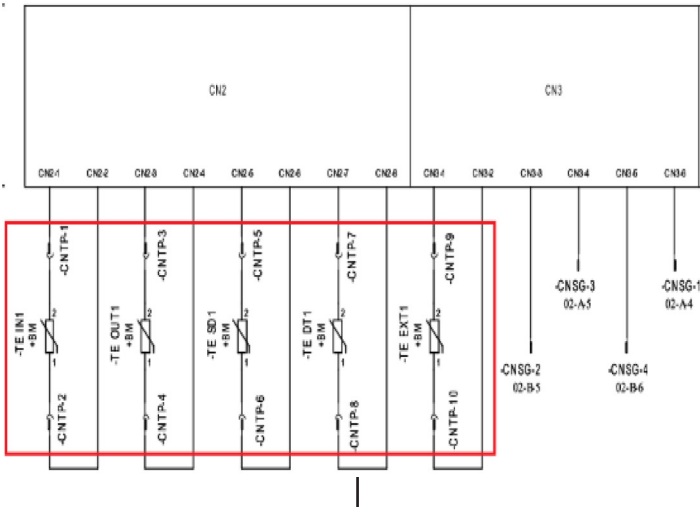

Code	Descriptif	Cause	What to check	What to do																																
E009	High flow temperature alarm	If the High flow temperature associated with the compressor exceeds 110°C for at least 30 seconds, the alarm is triggered, blocking the compressor. If the temperature exceeds 120°C, the error is activated without waiting for the timer. The alarm returns automatically when the exhaust temperature falls below the 100°C threshold again.	<ul style="list-style-type: none"> <li>Check the wiring of the exhaust sensor and that the bulb is correctly inserted in the thermowell with the presence of thermal paste.</li> <li>Check the connection of the CNFM panel connector (TE DT1)</li> <li>Checking correct fan operation</li> <li>Check refrigerant charge: Verify by means of the FT charging machine that charging has taken place correctly.</li> </ul>	<ul style="list-style-type: none"> <li>If the probe is not correctly positioned, correct it.</li> <li>Weigh the load and correct if necessary after leak detection</li> </ul>																																
E020	Reversed pressure transducer alarm	When compressors have been running for more than 150 seconds, if the suction pressure probe measures a higher pressure than the condensation pressure probe, then alarm E020 is signalled. This alarm cannot be reset (power must be cut to the machine to clear the alarm).	<ul style="list-style-type: none"> <li>Check correct positioning and wiring of low and high transducers on connector no. 7 (CNTR).</li> </ul> 	<ul style="list-style-type: none"> <li>If the connector does not respect the positions shown in the diagram, replace it.</li> </ul>																																
E611 E621 E631 E641 E651 E661 E671	Temperature probe failure	One of the control probes is defective, or connector no. 8 is not correctly connected	<ul style="list-style-type: none"> <li>Check the integrity of the probes.</li> <li>Check the fan</li> <li>Check the correct connection of connector No. 8.</li> </ul>	<ul style="list-style-type: none"> <li>If one of the probes is faulty, replace the CNTP connector.</li> </ul>																																
		<table border="1"> <thead> <tr> <th>C.n°</th> <th>Broche</th> <th>Dénom.</th> </tr> </thead> <tbody> <tr> <td rowspan="8">CN2</td> <td>1</td> <td>TE INV1</td> </tr> <tr> <td>2</td> <td>Water input</td> </tr> <tr> <td>3</td> <td>TE OUT1</td> </tr> <tr> <td>4</td> <td>Water output</td> </tr> <tr> <td>5</td> <td>TE SD1</td> </tr> <tr> <td>6</td> <td>compressor suction</td> </tr> <tr> <td>7</td> <td>TE DT1</td> </tr> <tr> <td>8</td> <td>compressor discharge</td> </tr> <tr> <td rowspan="6">CN3</td> <td>1</td> <td>TE EXT1</td> </tr> <tr> <td>2</td> <td>outdoor sensor</td> </tr> <tr> <td>3</td> <td>/</td> </tr> <tr> <td>4</td> <td>/</td> </tr> <tr> <td>5</td> <td>/</td> </tr> <tr> <td>6</td> <td>/</td> </tr> </tbody> </table>	C.n°	Broche	Dénom.	CN2	1	TE INV1	2	Water input	3	TE OUT1	4	Water output	5	TE SD1	6	compressor suction	7	TE DT1	8	compressor discharge	CN3	1	TE EXT1	2	outdoor sensor	3	/	4	/	5	/	6	/	
C.n°	Broche	Dénom.																																		
CN2	1	TE INV1																																		
	2	Water input																																		
	3	TE OUT1																																		
	4	Water output																																		
	5	TE SD1																																		
	6	compressor suction																																		
	7	TE DT1																																		
	8	compressor discharge																																		
CN3	1	TE EXT1																																		
	2	outdoor sensor																																		
	3	/																																		
	4	/																																		
	5	/																																		
	6	/																																		

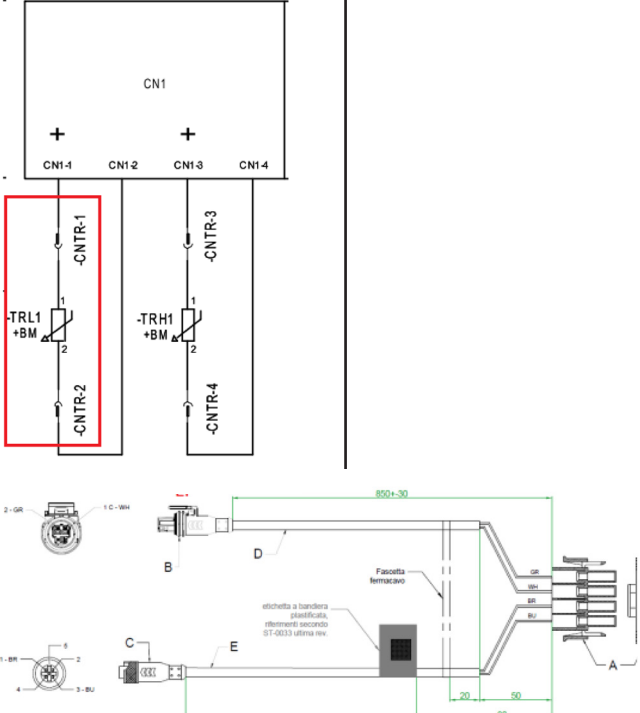
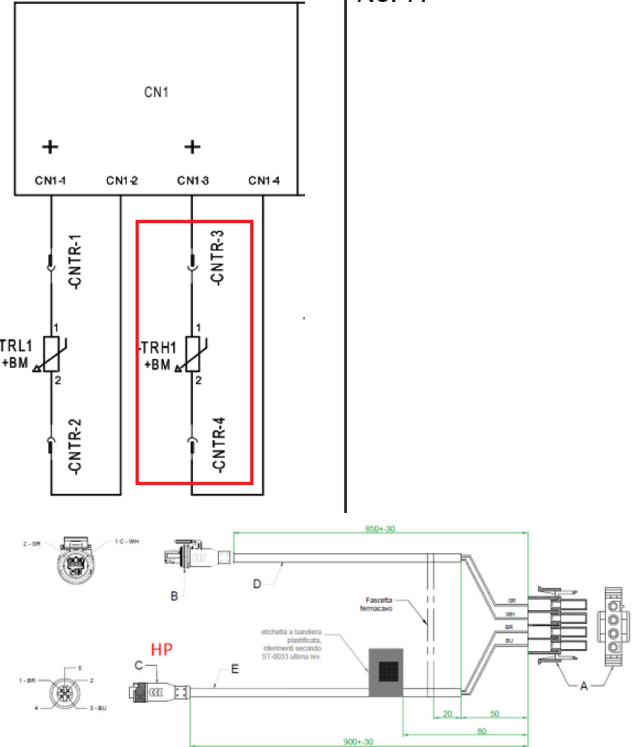
Code	Descrittif	Cause	What to check	What to do
E691	Low-pressure transducer failure	Transducer connected to input CN1-3 and CN1-4 not connected or faulty.	<ul style="list-style-type: none"> <li>• Check that transducer LP1 is connected to connector no. 7 at pins 1 and 2.</li> </ul> 	<ul style="list-style-type: none"> <li>• If the connector is connected correctly, the transducer may be defective. Replace with new connector No. 7</li> </ul>
E701	High-pressure transducer failure	Transducer connected to input CN1-2 and CN1-3 not connected or faulty.	<ul style="list-style-type: none"> <li>• Check that the HP1 transducer is connected to connector no. 7 at pins 3 and 4.</li> </ul> 	<ul style="list-style-type: none"> <li>• If the connector is connected correctly, the transducer may be defective. Replace with new connector No. 7.</li> </ul>

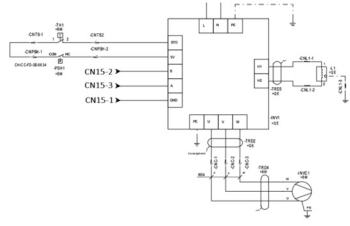
Code	Descriptif	Cause	What to check	What to do						
E801 (*)	Inverter/control board communication timeout	<ul style="list-style-type: none"> <li>The compressor does not respond to the control for more than 30 seconds.</li> <li>The communication cable between the control and inverter is not connected or is defective.</li> </ul>	<ul style="list-style-type: none"> <li>Check the communication cable between control CNTR1 connector CN15 and inverter INV1:</li> </ul> 	<ul style="list-style-type: none"> <li>Replace wiring between CNTR1 and INV1</li> <li>If the error persists, replace the CNTR1 control board.</li> <li>If the error persists, replace the INV1 compressor driver</li> </ul>						
E851 (*)	Hardware Problem of the inverter	Faulty inverter or compressor. Incorrect connection between inverter and compressor		<p>Check the continuity of the connection between U, V and W of the inverter and U, V, W of the compressor. Replace the driver. Check the impedance between the compressor phases :</p> <table border="1" style="margin-left: auto; margin-right: auto;"> <thead> <tr> <th colspan="2">Coil resistance at 20°C</th> </tr> </thead> <tbody> <tr> <td>23kW</td> <td>0.299 Ω</td> </tr> <tr> <td>27kW</td> <td>0.177 Ω</td> </tr> </tbody> </table> <p>If it deviates from the previous values, replace the compressor.</p> <ul style="list-style-type: none"> <li>Check the number of flashes of the inverter LED.</li> </ul>	Coil resistance at 20°C		23kW	0.299 Ω	27kW	0.177 Ω
Coil resistance at 20°C										
23kW	0.299 Ω									
27kW	0.177 Ω									

(\*) erreur de l'inverter :

Control error	Number of flashes - Error description	Causes	Solutions
E851	/ - Compressor start-up error		Change inverter
E861	/ - AC overcurrent protection		Change inverter
E871	/ - IPM module high-temperature protection	Defective IPM module	Change inverter
E881	/ - Overvoltage	Power supply voltage too high	
	/ - Supply voltage too low	Power supply voltage too low	
E891	/ - Lack of power supply phases	One or more power phases of the inverter are not connected	Check inverter power phase wiring
	/ - Power phase problem (software)	Defective inverter	Change inverter
E911	/ - Compressor over-current protection	The compressor rotor is blocked	Replace the compressor

Control error	Number of flashes - Error description	Causes	Solutions
E921	/ - Over-current protection PFC module	Defective inverter	Change inverter
E941	/ - Temperature sensor error of the PFC module	Defective inverter	Change inverter
E951	/ - Temperature sensor error IPM module	Defective inverter	Change inverter
E961	/ - Abnormal operation AD module	Defective inverter	Change inverter
	/ - Compressor supply phase failure	One or more power phases of the compressor are not connected	Check compressor power phase wiring
	/ - Compressor speed error	Defective inverter	Change inverter
	/ - MCU module error	Defective inverter	Change inverter
E971	/ - EEPROM error	Faulty EEPROM	Change inverter
E981	40 - High pressure triggering of max. gas pressure switch or compressor safety thermostat	Open STO input	Check the pressure measured by the high-pressure transducer

## 7. MAINTENANCE OF THE OUTDOOR UNIT

### 7.1. Draining water from outdoor unit

If the unit has to be completely drained, first close the manual inlet and outlet valves (not supplied) and then disconnect the pipes provided on the outside of the water inlet and outlet so that the liquid contained in the unit can be evacuated (to make this easier, we suggest installing two drain taps on the outside of the water inlet and outlet between the unit and the manual valves).

Unscrew the plug of the service valve and connect a 14 or 12 mm hose (inner diameter - check the type of valve installed on the unit) connected to the water mains, then charge the system by unscrewing the special ring. When the operation is complete, tighten the ring and refit the plug. In all cases, we recommend filling the system using an external tap that has been fitted by the installer.

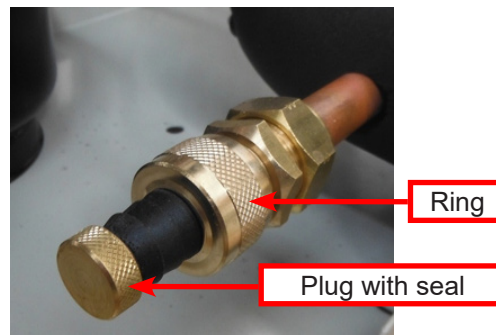

### 7.2. Filling the outdoor unit with water

Refer to paragraph 3.6.6.

### 7.3. Prolonged shutdown

The methods for powering down depend on the application site and the shutdown period corresponding to the installation. The appliance has a frost-free system, even when the appliance is switched "Off".



**CAUTION:**

**The frost-free protection function remains active only if the appliance is left connected to the electrical power supply.**

If the system is due to be shut down for a long period, we recommend draining the hydraulic system.

Switching off the appliance completely after draining the installation:

- Switch off the appliances using the "OFF" switch on each one.
- Close the water taps.
- Switch the differential circuit breaker on "OFF".



**CAUTION:**









**If the temperature drops below zero, there is a serious risk of freezing: drain the heat pump's system and hydraulic circuits.**



**CAUTION:**

**Operation even for a short period of time, with a water temperature below +5°C is not covered by the warranty. Before switching the appliance back on after prolonged stoppage, ensure that the temperature of the water is at least +5°C or more.**

## 7.4. Periodic checks

	<p>All of the operations described in this chapter <b>MUST ALWAYS BE CARRIED OUT BY QUALIFIED PERSONNEL</b>. Before carrying out any work on the appliance or accessing internal components, make sure that the electrical power supply has been disconnected.</p>
	<p>Before starting work, safety checks must be carried out to ensure that there is the least risk of combustion possible. Work should be carried out to a controlled procedure, to minimise the risk of the presence of flammable gases or vapours during the work. The area must be checked using a suitable refrigerant gas detector before and during the work.</p>
	<p>Maintenance must only be carried out in weather conditions that are suitable for the operations envisaged.</p>
	<p>It is possible that a certain quantity of compressor oil be may be deposited in the refrigeration circuit pipes, especially in the bends. For maintenance operations that need pipes to be where it is necessary to desolder the pipes, we strongly recommend cutting the pipes and not desoldering them with a torch, as the flame may trigger the combustion of any oil present..</p>
	<p>When working on the machine, the operator must always carry a personal R290 refrigerant gas detection explosimeter, calibrated to a maximum threshold of 20%LFL (this device must be compliant for use in fire risk areas and not be an ignition source).</p>
	<p>It is forbidden to fill the refrigeration circuits with a refrigerant other than the one indicated on the rating plate. The use of another refrigerant may seriously damage the compressor.</p> <p>It is forbidden to use any other oils than those listed in this manual. The use of a different oil may seriously damage the compressor</p>
	<p>Compressor heads and discharge lines are generally at fairly high temperatures.</p>
	<p>Be very careful when working next to the batteries. The aluminium fins are very sharp and can cause serious injury*. Always wear the appropriate personal protective equipment (PPE).</p>
	<p>After finishing the maintenance operations, replace the panels and fasten them using the attachment screws. Pay special attention to closing the electrical component housing correctly.</p> <p>After finishing the maintenance operations, ensure that the electrical power supply cable gland is tightened correctly.</p> <p>Before working on the appliance, make sure that you have the appropriate work equipment, which is compatible with the use of flammable gases.</p>
	<p>During the winter months when the weather is particularly cold and humid, ice can form on the protective grilles on the front of the appliances. To allow proper air circulation, check for such ice deposits and remove them if necessary.</p> <p>After maintenance work, make sure that the power supply cables are correctly positioned in the respective eyelets of the user board housing.</p> <p>When working near the appliance, it is advisable to examine whether it is necessary to switch off the appliance, empty it of its refrigerant, or protect it with appropriate protective devices. If the product must be placed in an area in which vehicles perform manoeuvres, fit appropriate collision protection.</p>



**We recommend carrying out checks and periodic maintenance operations by specialised personnel. EU Regulation 517/2014 stipulates that users must have regular checks carried out on the installations, Check their tightness and eliminate leaks as soon as possible. Check the mandatory nature and necessary documentation of Regulation 517/2014 and its subsequent amendments or repeals.**

OPERATIONS	1 month	4 months	6 months	12 months
Fill the water circuit (R)	X			
Presence of air bubbles in the water circuit (R)	X			
Check the control and safety devices are working correctly (M)	X			
Check for oil leaks from the compressor (R)	X			
Check for water leaks in the hydraulic circuit (R)	X			
Check If the flow meter is working correctly (M)	X			
Check if the crankcase resistors are powered and operating (R)	X			
Clean the metal filters on the hydraulic circuit (M)	X			
Verify that the flow rate of each HP is greater than or equal to the minimum allowable flow rate		X		
Clean the finned battery with compressed air (R)		X		
Check if the electrical terminals inside the electrical cabinet and on the compressor terminals are attached correctly (M)		X		
Tighten the hydraulic connectors (R)		X		
Check that the fans are attached and balanced (R)		X		
Clean the air filters in the electrical cabinet or replace them if necessary (if present) (M)		X		
Check the electrical voltage and phase unbalance (no load and load) (R)			X	
Verification of absence of vibration (R)			X	
Verification of the refrigerant charge as per the regulations in force (M)			X	
Verification of the service, overheating and under-cooling pressures (R)			X	
Check that the pump is operating correctly (R)			X	
If the appliance has to be switched off for a prolonged period of time, drain the water from the pipes and the heat exchanger. This operation is necessary if, during the shut-down period, the expected ambient temperatures are below the freezing point of the fluid used (M)			X	
Check for the presence of corrosion/oxidation (R)				X
Check the panel is attached (R)				X
Factory tightening torque (M)				X
Check the water quality (refer to the chapter on System water characteristics)			X	
Check safety valve on the hydraulics side (R)			X	
Check that there is no expansion at any dehydrator filter on the liquid line (R)			X	
Clean the degasser (M)			X	

R = Recommended - M = Mandatory

### 7.4.1. CLEANING THE EVAPORATOR

Follow the instructions below to clean correctly:

a) Remove any surface dirt. Deposits such as leaves, fibres... etc., must be used with a vacuum cleaner (use a brush or a spray, carefully avoiding rubbing with metal parts or abrasives). If compressed air is to be used, ensure that the air stream is kept pointing perpendicularly to the surface of the battery to avoid bending the aluminium fins. Take care not to bend the fins with the nozzle of the compressed air gun.

b) Rinse with water. Chemicals may be used (specific products for finned batteries). Rinse it by running water through each of the finned passages until they are completely clean. Ensure that the water stream is kept pointing perpendicularly to the surface of the battery to avoid bending the aluminium fins. Do not spray the evaporator with the stream of water. We recommend limiting the pressure to avoid damaging the fins

#### 7.4.1.1. *Cleaning the evaporator: models ECOMOD 23-AC and ECOMOD 27-AC*

The anti-corrosion treatment applied to the evaporators (available as an alternative to standard evaporators) protects against aggressive atmospheres.

The frequency of cleaning depends on the environmental conditions and is left to the common sense of the maintenance personnel. When oxidising dust or particles of grease are observed on the surface of the evaporator, we recommend cleaning it. In general, in a slightly polluted atmosphere, it is recommended to carry out the cleaning treatment every three months.

Wash preferably with hot water (40-60 °C) and a pH-neutral detergent, then rinse thoroughly with cold water (50 L/m<sup>2</sup>).

If the maintenance personnel notices that the protective cover is missing on the edge of the fins, contact the nearest service centre to reapply the cover and completely restore the corrosion protection.

	<p><b>Do not use a high pressure cleaner to clean the evaporator, as excessive pressure can cause irreparable damage. Damage caused by cleaning with unsuitable chemicals or excessive water pressure will not be covered by the warranty.</b></p>
	<p><b>The aluminium fins are thin and sharp. Take care to use suitable PPE to avoid cuts and abrasions. Protect eyes and face properly to avoid splashing water and dirt during cleaning. Wear waterproof shoes or boots and clothing that cover all parts of the body.</b></p>
	<p><b>For units installed in an aggressive atmosphere with a high degree of soiling, cleaning the evaporator should be part of the routine maintenance programme. On this type of installation, all dust and particles deposited on the batteries must be removed as soon as possible through periodic cleaning as described above.</b></p>

### 7.5. Cleaning the external surfaces

The outer panels must be properly cleaned in order to avoid the accumulation of dust/dirt that can lead to the appearance of corrosion. The paint protects against atmospheric agents, but we recommend cleaning these surfaces as frequently as possible with a neutral detergent and water, especially if the unit is installed in an aggressive atmosphere (high pollution level, salt, etc.).

### 7.6. Maintenance of the outdoor unit

All extraordinary maintenance operations must be carried out by persons trained in the handling of R290.



## 7.7. Residual safety risks

The residual risks associated with the handling, installation and normal operation of the appliance are listed below. Failure by the user and the installer to comply with the instructions/indications in the manual (the references of which are given in the table) leads to the persistence of these risks, which cannot be eliminated by the manufacturer, which has already taken all necessary design measures to ensure that each risk is minimised.

Danger	Indications/Instructions	Residual risk	User / Activity				
			Operator			User	
			Transport phase	Installation phase	Maintenance phase	Interactions with the unit	Normal operation of the unit
Mechanical: crushing caused by possible instability of the unit while it is being handled.	Chapter 3 of the User-Installer manual contains instructions on how to properly handle and install the unit, indicating the centre of gravity, lifting points and the equipment to be used. It is also recommended to use the protective equipment required by current regulations.	Failure by the installation technician to observe the installation procedures.	X	X			
Mechanical: crushing caused by possible instability of the unit.	Chapter 3 of the User-Installer manual contains instructions on how to correctly install the unit.	Failure by the installation technician to observe the installation procedures.		X	X		
Mechanical: cutting/sectioning/shearing caused by the fact that the fan is not protected against accidental contact.	Chapter 7 of the User-Installer Manual contains specific cautions also concerning the ordinary maintenance phases.	Removal of the protective grille by the user or the maintenance technician.			X	X	
Entanglement caused by the fact that the fan is not protected against accidental contact.	Chapter 7 of the User-Installer Manual contains specific cautions also concerning the ordinary maintenance phases.	Removal of the protective grille by the user or the maintenance technician.			X	X	
Mechanical: cut/abrasion due to contact with the heat exchanger coil.	Chapter 7 of the User-Installer manual contains specific warnings to be taken into account when working near the battery.	Failure to observe the warnings in the manual and in label form.			X	X	
Mechanical: slip/fall caused by ice/water in the vicinity of the unit due to water leaks, broken pipes or seals, or draining of the safety valve on the water side in the event of overpressure and water supply failure.	Paragraph 3.6.2 of the User-Installer manual, recommends taking care when transporting the ATO water safety valve, and paragraph 2.4.3 provides guidance on the plane on which the unit rests. During maintenance, the use of PPE is recommended, as well as the possible removal of all water residues near the machine after the work.	Failure to comply with the instructions in the manual.			X	X	
Mechanical: cut/abrasion caused by sharp edges on the outer casing of the machine and/or screws protruding on the outside and inside of the unit.	Chapter 7 of the User-Installer manual indicates the correct maintenance procedures. Paragraph 1.2.7 recommends the use of appropriate personal protective equipment.	Failure by the maintenance technician to observe the procedures and/or to use PPE.			X	X	

Danger	Indications/Instructions	Residual risk	User / Activity				
			Operator			User	
			Transport phase	Installation phase	Maintenance phase	Interactions with the unit	Normal operation of the unit
Mechanical: projection of parts or fluids caused by operating pressure limits being exceeded.	Chapter 7 of the User-Installer manual indicates the correct maintenance procedures. Paragraph 1.2.7 recommends the use of appropriate personal protective equipment.	Simultaneous damage to both types of protective equipment.			X	X	
Mechanical: entrapment due to the closing of the access panel with someone inside.	The unit has a square footprint and the interior is clearly visible.	No check at closing, but this is unlikely to occur given the footprint and size of the unit.			X		
Mechanical: push or impact due to the open door accidentally moving.	Paragraph 1.2.7 recommends the use of appropriate personal protection. And paragraph 1.2.6 highlights the risk to the operator.	Failure by the maintenance technician to follow procedures or behaviour.			X		
Mechanical: cut/abrasion caused by the fins of the inverter heat sinks.	Paragraph 1.2.7 recommends the use of appropriate personal protection.	Failure by the maintenance technician to use PPE.			X		
Electrical: electric shock/bumps/burns caused by contact with live parts.	Chapter 7 of the User-Installer manual contains the safety measures to be taken when maintaining, cleaning or checking the unit. All work must be carried out by qualified personnel only and with the machine switched off.	Failure by the maintenance technician to follow procedures or irresponsible behaviour on the part of the User.			X	X	
Electrical: effects on medical implants (pacemakers) caused by electromagnetic phenomena.	Paragraph 1.2.5 of the User-Installer manual states that direct interaction with the unit by persons wearing electrically operated medical devices, such as pacemakers, is prohibited. It is recommended to keep away from the unit's installation location, as indicated by the medical system used.	Failure to comply with the instructions in the manual.			X	X	
Electrical: fire caused by short circuits or electrical arcing.	Chapter 3 of the User-Installer manual describes how to perform a proper installation. In case of maintenance, the use of appropriate personal protective equipment is recommended.	The possibility of a fire starting cannot be eliminated, but its probability of occurrence is reduced. The measures taken reduce the spread of fire.			X	X	
Electrical: projection of particles and emission of harmful chemicals as a result of an electrical overload.	Chapter 7 of the User-Installer manual states that maintenance must be carried out with the machine switched off.	Failure to comply with the instructions in the manual.			X	X	

Danger	Indications/Instructions	Residual risk	User / Activity				
			Operator			User	
			Transport phase	Installation phase	Maintenance phase	Interactions with the unit	Normal operation of the unit
Thermal: burns from contact with hot surfaces.	Chapter 7 of the User-Installer manual provides the safety measures to be taken when maintaining, cleaning or checking the unit and the personal protective equipment to be worn.	Failure by the maintenance technician to observe the procedures and/or to use PPE.			X	X	
Generated by noise: discomfort caused by the noise of the unit during operation.	Chapter 3 of the User-Installer manual states that an environmental impact assessment must be carried out based on the area of installation of the unit, including installation near workers.	Failure to comply with the actions recommended in the manual and the environmental impact assessment.					X
Generated by vibration: discomfort caused by vibrations of the unit during operation.	In Chapter 3 of the User-Installer manual, the use of anti-vibration mounts is recommended.	Failure to comply with the actions recommended in the manual and the environmental impact assessment.					X
Generated by radiation: electromagnetic radiation that the unit generates during operation.	-	None.					X
Generated by materials/substances: breathing difficulties and/or damage to eyes and skin caused by possible leakage of refrigerant gas.	In the User-Installer manual, paragraph 1.2.7, the use of personal protective equipment is recommended. The refrigerant's safety data sheet (paragraph 1.2.3) and the specific warnings (paragraph 1.2.3) are also provided.	Failure by the maintenance technician to follow procedures.			X	X	
Generated by materials/substances: fire/explosion creates a gas classified as flammable.	Chapter 3 of the User-Installer manual contains specific information on the place of installation of the machine and protective devices.	Failure to comply with instructions regarding the place of installation and the appropriate maintenance procedures.			X		X
Generated by materials/substances: infections caused by bacteria potentially present in the carrier fluid (technical water).	The permitted uses of the unit are listed in Chapter 3.4.1 of the User/Installer manual.	Failure to comply with the instructions in the manual.			X		X
Generated by materials/substances: burns caused by the presence of R290 dissolved in the oil inside the cooling circuit, triggered by the flame of a torch.	In the User-Installer manual, paragraph 1.2.7, the use of personal protective equipment is recommended. In Chapter 7, it is recommended that, in case of maintenance involving the de-soldering of pipes, the pipes themselves should be cut, as the flame of the de-soldering torch will ignite any oil that may be present.	Failure to comply with the instructions in the manual.			X		

Danger	Indications/Instructions	Residual risk	User / Activity				
			Operator			User	
			Transport phase	Installation phase	Maintenance phase	Interactions with the unit	Normal operation of the unit
Generated by materials/substances: burns due to refrigerant leakage.	Chapter 7 of the User-Installer manual provides the safety measures to be taken when maintaining, cleaning or checking the unit and the personal protective equipment to be worn.	Failure to comply with the instructions in the manual.			X		X
Generated by materials/substances: pollution due to improper disposal.	Chapter 8 of the User-Installer Manual contains information on proper disposal.	Failure to comply with the instructions in the manual.					
Ergonomic: fatigue/musculoskeletal disorders caused by the effort exerted during maintenance/installation.	Paragraph 1.2.6 of the User-Installer manual recommends compliance with the applicable regulations (international and local) concerning the health and safety of workers. During maintenance, it is advisable to maintain a posture that does not cause fatigue, and to check the weight of a component before handling it.	Failure to comply with the instructions in the manual.		X	X		
Generated by the operating environment of the machine: Slip/fall caused by ice/water near the unit due to condensate drainage/defrosting.	In the User-Installer manual, paragraph 3.4.3. deals with the condensate drainage system and recommends paying attention to the risk of slipping.	Failure to comply with the instructions in the manual.			X	X	
Generated by the operating environment of the machine: unforeseen events following malfunctions due to water/snow/humidity.	In chapter 7 of the User-Installer manual, it is recommended to pay attention to the correct positioning of the power supply cables in their respective eyelets of the user board housing and to the reassembly of all sheet metal panels, especially those belonging to the electrical panel, in order to maintain the declared degree of protection.	Failure by the maintenance technician to follow procedures.			X	X	
Generated by the operating environment of the machine: lightning that can potentially strike the unit.	In Chapter 7 of the User-Installer manual, it is recommended to only carry out maintenance under weather conditions that are appropriate for the intended operations. It is also stated that the place of installation must be sufficiently far away from lightning conductors or objects likely to attract the discharge (§ 2.4.3). The unit must be electrically connected to a system that complies with applicable regulations.	Failure to comply with the instructions in the manual.			X	X	

Danger	Indications/Instructions	Residual risk	User / Activity				
			Operator			User	
			Transport phase	Installation phase	Maintenance phase	Interactions with the unit	Normal operation of the unit
Generated by the environment in which the machine is used: electromagnetic disturbances caused by interference between equipment in the vicinity of the machine and the machine in question.	Paragraph 3.7.3 of the User-Installer manual recommends that power should be supplied to the unit via a dedicated line and with protective devices. It is also advisable to use an independent cable to eliminate any possibility of interaction with other appliances	Failure to comply with the recommendations concerning the electrical installation.					X
Generated by the operating environment of the machine: possible breakage of components/supports caused by corrosion and oxidation.	Chapter 7 of the User-Installer manual contains specific instructions on the maintenance and cleaning to be performed on the surfaces of the heat exchanger plates and coils. The data sheet provides guidance on the treatments to be chosen depending on the environmental conditions.	Lack of cleanliness and maintenance and/or incorrect assessment of the atmospheric agents that characterise the installation location.			X	X	

## 7.8. “Maintenance” check list

- Before starting any work on equipment containing flammable refrigerant, safety checks must be performed to minimise the risk of ignition. Take the following steps before working on the cooling system:

	Measure	Performed	Comment
1	<p><b>General working environment</b></p> <ul style="list-style-type: none"> <li>■ Inform all of the following persons of the type of work to be carried out:                             <ul style="list-style-type: none"> <li>– All of the maintenance personnel.</li> <li>– All persons near to the installation.</li> </ul> </li> <li>■ Prohibit access to the heat pump.</li> <li>■ Check for flammable materials and ignition sources in the immediate vicinity of the heat pump: remove all flammable materials and ignition sources.</li> </ul>		
2	<p><b>Check that the refrigerant is present</b></p> <ul style="list-style-type: none"> <li>■ To detect a flammable atmosphere in good time: check for refrigerant leaks in the environment before, during and after the work using an explosion-proof refrigerant detector suitable for R290.</li> </ul> <p>This refrigerant detector must not generate sparks and must be properly sealed.</p>		
3	<p><b>Extinguisher</b></p> <p>A CO2 or powder extinguisher must be available for the following situations:</p> <ul style="list-style-type: none"> <li>■ When welding or brazing.</li> </ul>		
4	<p><b>Sources of ignition</b></p> <ul style="list-style-type: none"> <li>■ When working on a refrigeration circuit containing or having contained flammable refrigerant, it is forbidden to use ignition sources that could cause the refrigerant to ignite.</li> </ul> <p>Remove all sources of ignition from the environment where the installation, repair, disassembly or disposal work is being performed, where the risk of refrigerant leaks cannot be excluded.</p> <ul style="list-style-type: none"> <li>■ Check for the presence of flammable materials and ignition sources in the immediate vicinity of the heat pump before proceeding with the work:</li> </ul> <p>Remove all flammable materials and ignition sources.</p>		
5	<p><b>Ventilation of the work site</b></p> <ul style="list-style-type: none"> <li>■ Perform repairs outdoors or ventilate the work area sufficiently using an ATEX fan before working on the refrigeration circuit or before welding or brazing.</li> <li>■ Ventilation must be maintained throughout the work. The ventilation must dilute the refrigerant that may escape to the outside.</li> </ul>		

Measure	Performed	Comment
<p><b>6</b></p> <p><b>Checking the refrigeration installation</b></p> <ul style="list-style-type: none"> <li>■ Replacement electrical components must be suitable for the application and meet the manufacturer's specifications. Only replace defective components with original parts.</li> <li>■ Replace the components according to the instructions in the manual. Where necessary, call on the Ideal Heating's technical department.</li> </ul> <p>Carry out the following checks:</p> <ul style="list-style-type: none"> <li>■ The refrigerant load must not exceed that allowed for the installation room.</li> <li>■ The ventilation openings must not be obstructed or blocked.</li> <li>■ Check there is refrigerant present in the secondary circuit if a hydraulic decoupling system is used.</li> <li>■ The inscriptions and symbols must always be clearly visible and legible. Replace illegible information.</li> <li>■ Refrigerant lines or components must be installed in such a way as to avoid contact with substances that may cause corrosion.</li> </ul> <p>Exception: refrigerant lines must be made of corrosion-resistant materials or be sufficiently protected against corrosion.</p>		
<p><b>7</b></p> <p><b>Checking the electrical components</b></p> <ul style="list-style-type: none"> <li>■ The following safety checks must be carried out during maintenance and repair work on the electrical components: see below.</li> <li>■ In the event of a safety-related fault, the system must not be connected until the fault has been rectified.</li> </ul> <p>If immediate rectification of the fault is not possible, a suitable temporary solution must be found to allow the system to operate. Inform the user.</p> <p><b>Carry out the following safety checks:</b></p> <ul style="list-style-type: none"> <li>■ When filling or sucking out refrigerant and when flushing the refrigeration circuit, do not place electrical components or live cables in the immediate vicinity of the appliance..</li> <li>■ Check the earth connection.</li> </ul>		
<p><b>8</b></p> <p><b>Repairs to sealed units</b></p> <ul style="list-style-type: none"> <li>■ When working on the sealed components, switch off the appliance completely, even before removing the sealed covers.</li> <li>■ If a power supply is absolutely necessary during the work: to prevent a potentially dangerous situation, a permanently operating refrigerant detector should be installed at the most critical locations. The use of an ATEX retractor is advisable.</li> </ul>		

	Measure	Performed	Comment
8	<ul style="list-style-type: none"> <li>■ In particular, care must be taken to ensure that, when working on electrical components, the units are not modified to such an extent that the protection they offer is affected. Such modifications include damage to cables, too many connections on a single terminal block, connections that do not comply with the manufacturer's specifications, damage to seals and incorrect installation of cable glands.</li> <li>■ Ensure that the device is installed correctly.</li> <li>■ Check that the seals are fully inserted. This ensures that the seals provide reliable protection against the penetration of a flammable atmosphere. Change if defective.</li> </ul> <p><b>Warning</b></p> <p>The use of silicone as a sealant may affect the operation of the leak detectors. Do not use silicone as a sealant.</p> <ul style="list-style-type: none"> <li>■ Replacement parts must meet the manufacturer's specifications.</li> <li>■ Work on components suitable for flammable atmospheres: these components do not have to be powered down.</li> </ul>		
9	<p><b>Repair work on components suitable for use in flammable atmospheres</b></p> <ul style="list-style-type: none"> <li>■ While we cannot completely rule out exceeding the permissible voltages and currents, permanent capacitive or inductive loads must not be connected to the device.</li> <li>■ Only components suitable for a flammable atmosphere may be powered up in the vicinity of such an atmosphere.</li> <li>■ Use only suitable original parts or components approved by the Ideal Heating. Other components may cause the refrigerant to ignite if leaked.</li> </ul>		
10	<p><b>Wiring</b></p> <ul style="list-style-type: none"> <li>■ Check if the wiring is subject to wear, corrosion, traction, vibrations, sharp edges or other unfavourable surrounding influences.</li> <li>■ When checking, also take into account the effects of ageing or constant vibrations at the compressor and fans.</li> </ul>		
11	<p><b>Refrigerant detectors</b></p> <ul style="list-style-type: none"> <li>■ Do not use potential ignition sources to detect refrigerant and leaks.</li> <li>■ Flame detectors or detectors with naked flames are prohibited.</li> </ul>		
12	<p><b>Leak detection</b></p> <p>The following leak detection methods are suitable for installations with flammable refrigerants:</p> <p><b>Leak detection using electronic refrigerant detectors:</b></p> <ul style="list-style-type: none"> <li>■ If necessary, electronic refrigerant detectors do not have the necessary sensitivity or must be calibrated to the corresponding range. Calibrate in a refrigerant-free environment.</li> </ul>		



Measure	Performed	Comment
<p>12</p> <ul style="list-style-type: none"> <li>■ The refrigerant detector must be suitable for the R290 refrigerant to be detected.</li> <li>■ The refrigerant detector must not contain any potential source of ignition.</li> <li>■ Calibrate the refrigerant detector to suit the refrigerant used. Set the response threshold to &lt; 3 g/a, suitable for propane.</li> </ul> <p><b>Leak detection using leak detection liquids:</b></p> <ul style="list-style-type: none"> <li>■ Leak detector liquids associated with most refrigerants are suitable.</li> </ul> <p><b>Warning</b></p> <p>Liquid leak detectors containing chlorine react with the refrigerant, causing corrosion.</p> <ul style="list-style-type: none"> <li>■ Do not use liquid leak detectors containing chlorine.</li> </ul> <p><b>Measures to be taken when there is a leak in the refrigeration circuit:</b></p> <ul style="list-style-type: none"> <li>■ Immediately extinguish any open flame in the vicinity of the heat pump.</li> <li>■ Always recover all refrigerant from the refrigeration circuit if brazing work is required to eliminate the leak.</li> </ul> <p>Flush the area to be brazed with oxygen-free nitrogen before and during brazing.</p>		
<p>13</p> <p><b>Recovering the refrigerant</b></p> <p><b>Recovery and evacuation of the refrigerant</b></p> <p>If any work is to be done in the refrigerant circuit for repair or other reasons, it should be done according to standard procedures. In general, special care must be taken with regard to the flammability of the refrigerant. The following procedure should be followed in all cases:</p> <ul style="list-style-type: none"> <li>- do not fill a recovery bottle to more than 40% of its capacity because the R290 has a density of 0.42kg/l.</li> <li>- recover the refrigerant;</li> <li>- purge the refrigerant circuit with dry nitrogen; evacuate;</li> <li>- purge again with inert gas;</li> <li>- open up the refrigerant circuit by cutting or brazing it.</li> </ul> <p>The refrigerant charge must be recovered in an appropriate recycling bottle. The refrigerant circuit must be purged with nitrogen to ensure safety. This process must be repeated several times if necessary. Under no circumstances should compressed air or oxygen be used.</p> <p>The purging process must be carried out by bringing oxygen-free nitrogen into the vacuum and raising the pressure to the operating pressure level.</p> <p>Then the excess pressure must be lowered and evacuated. This process must be repeated until no refrigerant remains in the system. Once the last purging process is completed, the pressure in the system must be reduced to the atmospheric pressure level. This is particularly important if brazing is to be carried out on the refrigerant circuit.</p> <p>Ensure that the outlet of the vacuum pump leads to a well ventilated area and that there are no flammable sources in the vicinity.</p>		

	Measure	Performed	Comment
14	<p><b>Topping up the refrigerant</b>  <b>Filling with refrigerant</b>                      In addition to the usual filling procedure, the following requirements must be satisfied:</p> <ul style="list-style-type: none"> <li>- make sure that the filling valve is not used for different refrigerants. The pipes should be as short as possible to minimise the amount of refrigerant contained.</li> <li>- the refrigerant bottles must remain in a vertical position.</li> <li>- make sure the refrigerant circuit is earthed before filling it.</li> <li>- the appliance may be marked (if not already marked) when the filling process is complete.</li> <li>- take special care not to overfill the appliance.</li> </ul> <p>Before the appliance is filled, a pressure test with nitrogen must be carried out. The leak test can be performed on the filled appliance, but it must be done before commissioning. A final leak test must be performed before leaving the facility.</p>		
15	<p><b>Disposal</b>                      For disposal, it is especially important that the technician is familiar with all details of the drainage equipment. We recommend that first of all the refrigerant is recovered. Before draining, take samples of the oil and refrigerant if the refrigerant needs to be treated. The important factor is that there is a power supply available where the work is to be carried out.</p> <ol style="list-style-type: none"> <li>a) Familiarise yourself with the appliance and how it operates.</li> <li>b) The system must not be powered.</li> <li>c) Before starting the draining, ensure that:                         <ul style="list-style-type: none"> <li>- equipment is available (where required) to transport the bottles of refrigerant;</li> <li>- PPE are available and that they are used correctly;</li> </ul> </li> <li>- the suction process is constantly monitored by a qualified person;</li> <li>- the draining station and refrigerant bottles comply with the relevant guidelines.</li> <li>d) Carry out a pumping cycle, if possible.</li> <li>e) If a vacuum cannot be created, suck with a manifold hose so that the refrigerant can be removed from all parts of the system.</li> <li>f) Make sure that the refrigerant bottle is on the scale before starting the suction.</li> <li>g) Turn on the draining appliance and follow the manufacturer's instructions.</li> <li>h) Make sure that the recycling bottles are not overfilled (maximum filling capacity: 0.42kg/l).</li> <li>i) Never exceed the permissible operating overpressure of the recycling bottle, even for a short period.</li> </ol>		

	Measure	Performed	Comment
15	<p>j) If the recycling bottles are filled as required and the process is completed, ensure that the bottles and equipment are immediately removed from the facility and that all shut-off valves are closed.</p> <p>k) Recovered refrigerant must not be used to fill other systems until it has been purified and examined.</p>		
16	<p><b>Marking (on the heat pump)</b></p> <p>If the heat pump has been taken out of service, affix the following marking, along with the date and signature, prominently on the heat pump:</p> <ul style="list-style-type: none"> <li>■ The refrigerant is inflammable.</li> <li>■ The installation is not in service.</li> <li>■ The refrigerant has been removed.</li> </ul>		
17	<p><b>Recovering the refrigerant and the compressor oil Recovery</b></p> <p>If the refrigerant has to be recovered for repair or decommissioning, care must be taken to ensure that this is done safely.</p> <p>If the refrigerant is put into bottles, make sure that only appropriate refrigerant bottles are used for this purpose. Make sure that there are enough refrigerant bottles ready to receive the full volume in the installation. All refrigerant bottles used must be suitable for the refrigerant to be recovered and labelled accordingly (i.e., special recycling bottles for refrigerant recovery). The refrigerant bottles must contain a safety valve and shut-off valves that are firmly attached and in good condition. Empty recycling bottles are evacuated and must be cooled down before the suction process, if possible. The draining devices must be in good condition and suitable for the recovery of flammable refrigerant. Instructions for each step of the recovery procedure are to be found near to the device. In addition, calibrated scales must be available and in good condition. The hoses must be equipped with hermetic fittings and in good condition. Before using the draining device, you must check that it is in good condition, that it has been maintained correctly and that the electrical devices belonging to it have been waterproofed to avoid ignition in case of a refrigerant leak. In case of doubt, contact the manufacturer. The refrigerant recovered must be returned to the supplier in a proper recycling bottle. Do not mix refrigerants in the refrigerant bottles.</p> <p>When compressors or compressor oil are to be drained, care must be taken to ensure that they are drained at a pressure level that is sufficiently low to ensure that there is no refrigerant left in the oil. Before returning the compressor to the manufacturer, it must be evacuated. This process should only be accelerated by electrically heating the compressor housing. If the oil has to be removed from an installation, it must be done with appropriate caution.</p>		

## 8. End of product life

The regular elimination and appropriate recycling of this product will help prevent environmental damage and health risks.

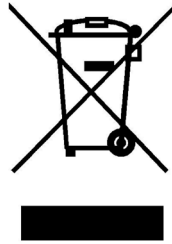

This crossed-out wheeled bin symbol on the equipment indicates that the product, at the end of its useful life, should be collected separately, and not disposed of with other solid/urban waste.

The equipment is manufactured in accordance with the European Directive on Waste Electrical/Electronic Equipment and the adverse effects of improper disposal are indicated in the user/installation manual. The manufacturer or its importer/distributor is available to answer any request for further information.

Ideal Heating has signed up to the Eco-systems service which collects, recycles and cleans our used electrical equipment, according to the highest environmental requirements.

Eco-systems is an eco-organisation which is approved by the public authorities for the WEEE (Waste Electrical and Electronic Equipment) sector.

The appliances which have the symbol above must not be put with domestic waste and must be collected separately. Contact Eco-systemes ([www.eco-systemes.fr](http://www.eco-systemes.fr)).

When the appliance has reached the end of its life cycle and needs to be replaced, a number of recommendations must be followed:

- the refrigerant must be recovered by specialised personnel and sent to a collection centre;
- any antifreeze solution that may have been added to the hydraulic circuit must be recovered and disposed of properly;;
- the lubricating oil of the compressors must also be recovered and sent to a collection centre;
- electronic components such as controllers, pilot boards and inverters must be removed and sent to a collection centre;
- if the structure and various components cannot be used, they must be dismantled and separated according to their nature, in particular copper and aluminium present in significant quantities in the device.

These operations facilitate the recovery and recycling of substances, thus reducing the environmental impact.

The user is responsible for the disposing of the product correctly in compliance with the national regulations in force in the country of destination. For further information, we recommend you to contact the installation company or the competent local authorities.

	<p>Incorrect disposal of the appliance may cause serious environmental damage and endanger people. We therefore recommend that you contact authorised persons with appropriate technical training obtained through courses recognised by the competent authorities.</p>
	<p>The same precautions described in the previous paragraphs must be followed.</p>
	<p>Special attention must be paid to the disposal of the refrigerant gas.</p>
	<p>Illegal disposal of the product by the end user will result in the application of the penalties provided for by the law in the country where the disposal takes place.</p>

### **Technical Training**

The Ideal Technical Training Centre offers a series of first class training courses for domestic, commercial and industrial heating installers, engineers and system specifiers.

For details of courses please ring:..... 01482 498432



Ideal Boilers Ltd. pursues a policy of continuing improvement in the design and performance of its products. The right is therefore reserved to vary specification without notice.

Ideal is a trademark of Ideal Boilers.

Registered Office

Ideal Boilers Ltd., PO Box 103, National Avenue, Kingston Upon Hull, HU5 4JN

Tel 01482 492251 Fax 01482 448858

Registration No. London 322 137

Ideal Technical Helpline: 01482 498376

[www.idealcommercialboilers.com](http://www.idealcommercialboilers.com)